

Lighting Products Interior

INDOOR CATALOGUE

2024-2025

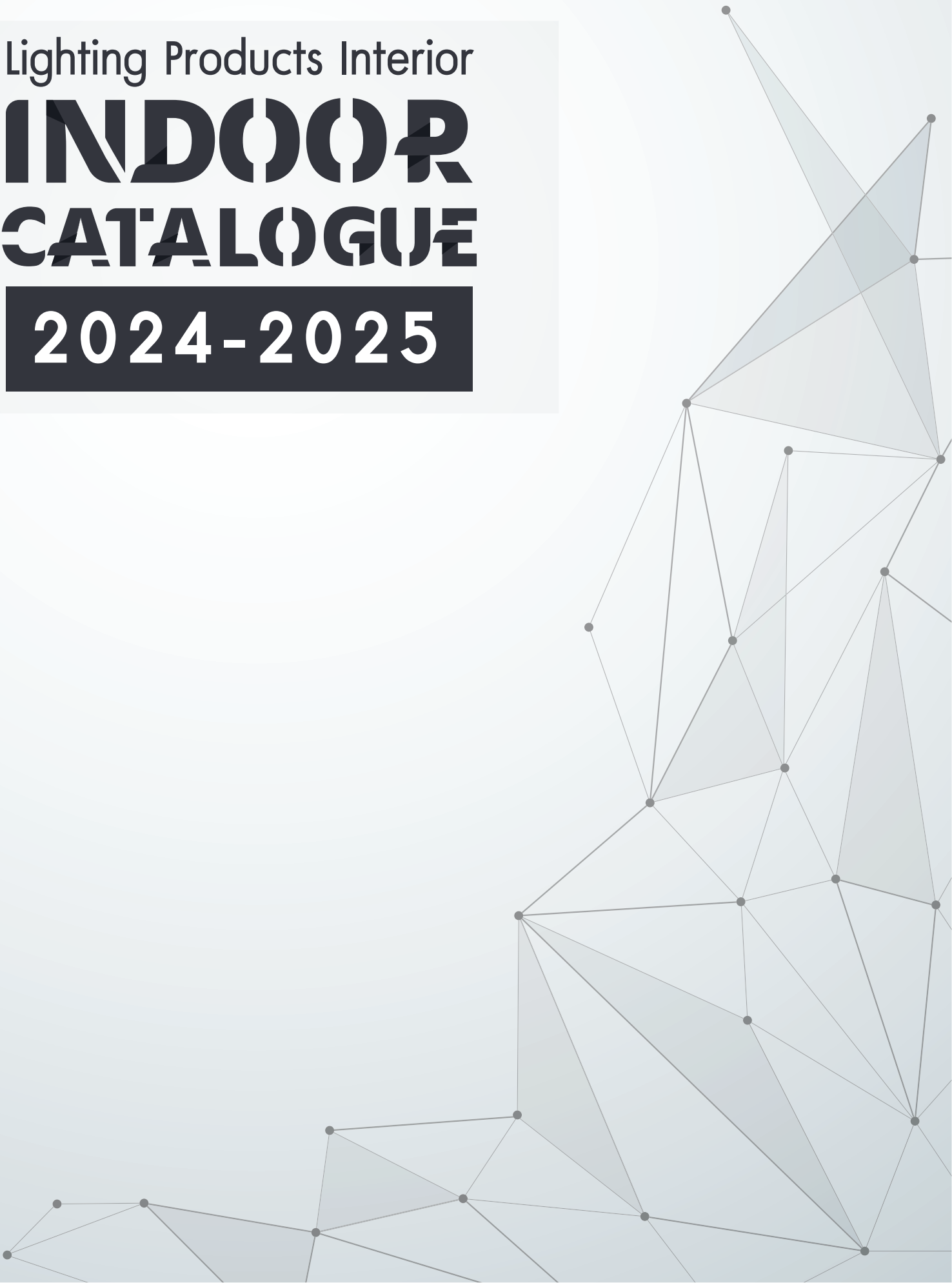

4 ช่องทางการติดต่อ EASY WAYS TO CONNECT LightTrio



WWW.LIGHTTRIO.COM

คุณสามารถเข้าไปชมแคตตาล็อก lighttrio ออนไลน์
และยังสามารถสั่งซื้อสินค้าและชำระเงินได้เลย หรือ
ดาวน์โหลดแคตตาล็อก

YOU CAN VIEW THE CATALOG ONLINE AND
LIGHTTRIO CAN ALSO ORDER AND PAY IT.
OR DOWNLOAD THE CATALOG



LINE ID : @LIGHTTRIO

ลูกค้าสามารถสอบถามข้อมูลสินค้าเพิ่มเติม และสั่งซื้อสินค้า
QUESTION & ANSWER PRODUCT ORDER

ร้านค้า ONLINE



WWW.FACEBOOK.COM/LIGHTTRIO

แพลตฟอร์มหน้าเพจของ LIGHTTRIO คุณสามารถ
ติดตามข่าวสาร เข้าร่วมกิจกรรม และอัปเดต
สินค้าใหม่ๆ เกี่ยวกับไลฟ์สไตล์ตลอดเวลา

PRODUCT UPDATE AND LATEST DESIGN
TREND ON LIGHTTRIO FACEBOOK



ITTHI

COMPANY PROFILE

ปี 2542 13 กันยายน 2542 จัดตั้ง หจก.อิทธิฤทธิ์อิเล็กทรอนิกส์ สำนักงานใหญ่ตั้งอยู่เลขที่ 163 ซ.พระรามที่ 2 ซ.71 ถ.พระราม 2 แขวงสามตำบล บางขุนเทียน กรุงเทพฯ เมื่อ ประกอบธุรกิจนำเข้าและเป็นตัวแทนจัดจำหน่ายผลิตภัณฑ์ประเภทคอมพิวเตอร์ และ ส่วนประกอบคอมพิวเตอร์ภายใต้แบรนด์ ITTHIRIT และเป็นผู้จัดจำหน่ายสินค้าสองสว่างแบรนด์ชั้นนำ เช่น Siemens Phillips Bticino Megaman

ปี 2553 ม.ค. เปลี่ยนชื่อแบรนด์จาก “ITTHIRIT” เป็น “LIGHTRIO” และขยายการจัดจำหน่ายตรงไปยังผู้พัฒนาโครงการอสังหาริมทรัพย์ชั้นนำของประเทศ มี.ค. ย้ายสำนักงานใหญ่และโรงงานของบริษัทไปยัง เลขที่ 89/18-19, 98/18-19 หมู่ที่ 5 ตำบลพันท้ายนรสิงห์ อ.เมืองสมุทรสาคร จ.สมุทรสาคร (ซึ่งเป็นที่ตั้งในปัจจุบัน)

ปี 2557 ต.ค. จัดทะเบียนเปลี่ยนแปลงจากห้างหุ้นส่วน จำกัด อิทธิฤทธิ์ อิเล็กทรอนิกส์ เป็น บริษัท อิทธิฤทธิ์ อิเล็กทรอนิกส์ จำกัด และเพิ่มทุนจดทะเบียนบริษัทเป็น 5 ล้านบาท เริ่มการจัดจำหน่ายผลิตภัณฑ์ประเภทโซล่าเซลล์ และสินค้าที่มีนวัตกรรมเทคโนโลยีสมัยใหม่ ประเภท LED

ปี 2558 ต.ค. เพิ่มทุนจดทะเบียนบริษัท เป็น 15.80 ล้านบาท เพื่อรองรับการเติบโตของยอดขาย

ปี 2560 ม.ค. ได้รับเครื่องหมายมาตรฐานอุตสาหกรรม (มอก.1955-2551) สำหรับนำผลิตภัณฑ์อุตสาหกรรม ผลิตภัณฑ์สองสว่างและผลิตภัณฑ์ที่คล้ายกันเพื่อจำหน่ายในราชอาณาจักรไทย

ปี 2561 ต.ค. เริ่มสร้างสินค้า ผลิตภัณฑ์ Home Automation มาจำหน่ายให้กับโครงการอสังหาริมทรัพย์ภายใต้แบรนด์ Lightrio Smart

ปี 2562 ก.ค. เพิ่มทุนจดทะเบียนบริษัทเป็น 27 ล้านบาท

ปี 2563 ก.ค. เปลี่ยนชื่อบริษัทจากเดิม ชื่อ “บจก.อิทธิฤทธิ์ อิเล็กทรอนิกส์” เป็น “บจก.อิทธิฤทธิ์ ไนซ์ คอร์ปอเรชั่น”

ปี 2564 เพิ่มทุนจดทะเบียน บจก. เป็น 41 ล้านบาท และขยายการจัดจำหน่ายผลิตภัณฑ์สองสว่างโดยใช้พลังงานจากแสงอาทิตย์ (Solar Light)

ปี 2565 เม.ย. เพิ่มทุนจดทะเบียนบริษัทเป็น 100 ล้านบาท และ ส.ค.เพิ่มทุนจดทะเบียนบริษัทเป็น 135 ล้านบาทพร้อมแปรสภาพเป็น บริษัท(มหาชน) เพื่อเตรียมเข้าจดทะเบียนในตลาดหลักทรัพย์

ปี 2566 ม.ค. เป็นตัวแทนจำหน่ายสินค้า นวัตกรรมเพื่อจำหน่ายให้กับภาครัฐ มี.ค. เข้าจดทะเบียน ในตลาดหลักทรัพย์ เอ็ม เอ ไอ โดยมีชื่อย่อบริษัทว่า “ITTHI”

ปัจจุบัน ผลิตสินค้าเสาไฟ Smart Pole และระบบ Smart City, ได้รับใบรับรองอุตสาหกรรมสีเขียว ระดับ 1, ได้รับหนังสือรับรองสินค้า Made in Thailand

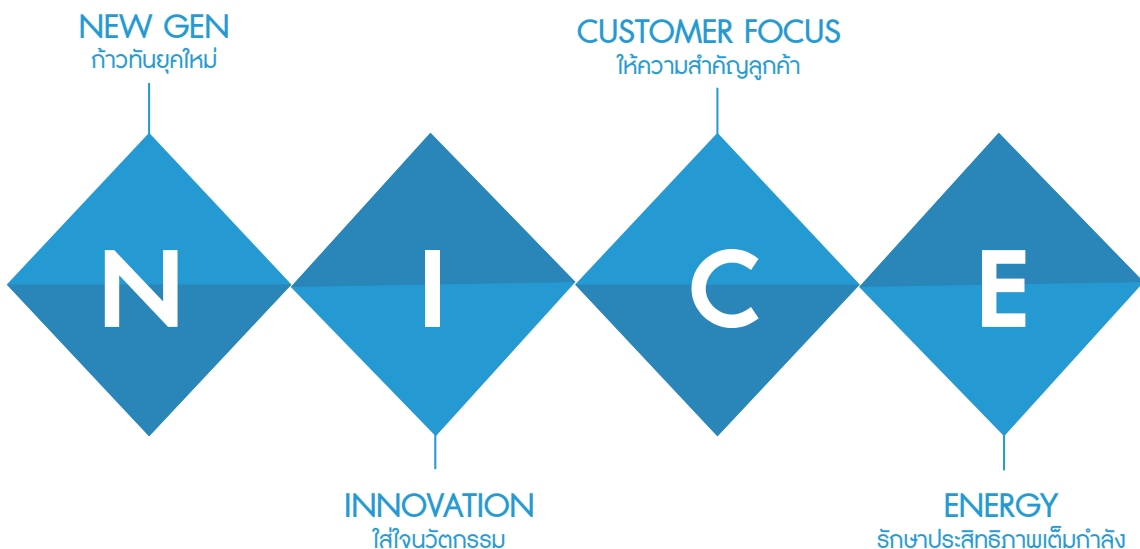

Our Business

การประกอบธุรกิจของบริษัท



แบบ มอ.๖
ลำดับที่ ๑

ใบอนุญาตที่ น 30869-7777/1955

ใบอนุญาต

นำผลิตภัณฑ์อุตสาหกรรมเข้ามาเพื่อจำหน่ายในราชอาณาจักร
อาศัยอำนาจตามความในมาตรา ๒๑ แห่งพระราชบัญญัติมาตรการกีดกันที่อุตสาหกรรม พ.ศ. ๒๕๑๑
เลขที่การสำนักงานมาตรฐานผลิตภัณฑ์อุตสาหกรรม
ออกใบอนุญาตฉบับนี้ให้
บริษัท อิทธิฤทธิ์ โนซ์ คอร์ปอเรชั่น จำกัด (มหาชน)
เลขประจำตัวผู้เสียภาษีอากร 0107565000565
มีสำนักงานใหญ่ตั้งอยู่เลขที่ 89/18-19 หมู่ที่ 5 ตระกอ/ซอย ถนน อำเภอ/เขต เมืองสมุทรสาคร จังหวัด สมุทรสาคร
นำผลิตภัณฑ์อุตสาหกรรม บริษัทที่ส่งสว่างและบริษัทที่คล้ายกัน ตามมาตรฐานผลิตภัณฑ์อุตสาหกรรม บริษัทที่ส่งสว่างและบริษัทที่คล้ายกัน : ชิดจำกัดสัญญาฉบับรวมนวัตกรรม
ตามมาตรฐานเลขที่ มอก. 1955-2551 เข้ามาเพื่อจำหน่ายในราชอาณาจักร
รหัสโรงงาน/ผู้ทำชื่อ
ตั้งอยู่เลขที่
รายละเอียดของผลิตภัณฑ์อุตสาหกรรมที่ได้รับอนุญาต แสดงไว้ในลำดับที่ ๒
บันทึกการเปลี่ยนแปลง แสดงไว้ในลำดับที่ ๓
ทั้งนี้ ผู้รับใบอนุญาตต้องปฏิบัติตามเงื่อนไขในการอนุญาตที่เลขาธิการกำหนด
ออกให้ ณ วันที่ 13 กันยายน 2565

(นางสมพร ไรจงดำรงการ)
ผู้อำนวยการกองควบคุมมาตรฐาน
ปฏิบัติราชการแทน
เลขาธิการสำนักงานมาตรฐานผลิตภัณฑ์อุตสาหกรรม



สำนักงานมาตรฐานผลิตภัณฑ์อุตสาหกรรม



signed by ผู้รับใบอนุญาตในผู้ลงทะเบียน (User)
The Industrial Standard Module (ISM)
Date 2022-09-13 17:40:04:37-07:00
01637356

หนังสือรับรอง MiT

เลขที่ MIT6507000298



Made in Thailand

โดยหนังสือฉบับนี้
สภาอุตสาหกรรมแห่งประเทศไทย ขอรับรองว่า

ผลิตภัณฑ์ เสาไฟภายนอกอาคาร

ผลิตโดย บริษัท อิทธิฤทธิ์ โนซ์ คอร์ปอเรชั่น จำกัด

เลขทะเบียนนิติบุคคล 0745557005777

เป็นผลิตภัณฑ์ที่ผลิตในประเทศไทย จรุงทุกประการ

(นายจรัส สว่างสมุทร)
ผู้อำนวยการใหญ่
สภาอุตสาหกรรมแห่งประเทศไทย



ใบรับรองนี้เป็นทรัพย์สินของสภาอุตสาหกรรมแห่งประเทศไทย (ส.อ.ก.)
ห้ามทำโดยไม่ขออนุญาต การฝ่าฝืนจะเป็นไปตามระเบียบที่ ส.อ.ก. กำหนด

Tel (+662)-345-1100 www.mit.fti.or.th

ออกให้ ณ วันที่ 15 07 2565
มีผลถึง ณ วันที่ 15 07 2566

สภาอุตสาหกรรมแห่งประเทศไทย
ขอรับรองสภาอุตสาหกรรม
ใบรับรองฉบับนี้
โปรดตรวจสอบใบรับรองที่
www.mit.fti.or.th



การรับรองเลขที่ : GI(E) 1-732/2566



กระทรวงอุตสาหกรรม

ใบรับรองฉบับนี้ให้ไว้กับ

บริษัท อิทธิฤทธิ์ โนซ์ คอร์ปอเรชั่น จำกัด (มหาชน)

ที่ตั้งสถานประกอบการ : เลขที่ 89/18-19 หมู่ที่ 5 ตำบลพันท้ายนรสิงห์
อำเภอเมืองสมุทรสาคร จังหวัดสมุทรสาคร 74000

เพื่อรับรองว่าเป็น

อุตสาหกรรมสีเขียวระดับที่ 1

ความมุ่งมั่นสีเขียว (Green Commitment)

มีความมุ่งมั่นที่จะลดผลกระทบสิ่งแวดล้อม และมีการสื่อสารภายในองค์กรให้ทราบโดยทั่วกัน

ลงชื่อ.....
(นายจุลพงษ์ ทวีศรี)
อธิบดีกรมโรงงานอุตสาหกรรม

ออกให้ ณ วันที่ : 22 พฤศจิกายน 2565
เลขประจำตัวผู้เสียภาษี : 0107565000565
เลขทะเบียนโรงงาน : --



ใบประกาศเกียรติคุณ

(Letter of Recognition: LOR)

โครงการสนับสนุนกิจกรรมลดก๊าซเรือนกระจก

(Low Emission Support Scheme: LESS)

กระทรวงทรัพยากรธรรมชาติและสิ่งแวดล้อม

โดย องค์การบริหารจัดการก๊าซเรือนกระจก (องค์การมหาชน)

เพื่อแสดงว่า

บริษัท อิทธิฤทธิ์ โนซ์ คอร์ปอเรชั่น จำกัด (มหาชน)

ดำเนินการ

กิจกรรมการเปลี่ยนอุปกรณ์ไฟฟ้าแสงสว่างเพื่อเพิ่มประสิทธิภาพ

สำหรับกิจกรรมเปลี่ยนหลอดไฟให้เป็นหลอด LED

กิจกรรมการผลิตพลังงานไฟฟ้าจากพลังงานหมุนเวียนเพื่อใช้เองกิจกรรมติดตั้งแผงโซลาร์เซลล์

ได้รับการประเมินว่าสามารถลดก๊าซเรือนกระจกได้

38.524 ตันคาร์บอนไดออกไซด์เทียบเท่า

(1 มกราคม 2564 - 31 ธันวาคม 2565)

นายเกียรติชาย ไมตรีวงษ์

ผู้อำนวยการองค์การบริหารจัดการก๊าซเรือนกระจก

ให้ไว้ ณ วันที่ 28 เมษายน พ.ศ. 2566

PROJECT REFERENCE

RESIDENTIAL COMPLEX

ASSETwise

บริษัท แอสเซทไวส์ จำกัด (มหาชน)

Modiz Sukhumvit : สุขุมวิท 50

Brown Condo : ห้วยขวาง, พหลโยธิน 67

IVORY : รัชดา 32

Atmoz : ลาดพร้าว 71, ลาดพร้าว 15, รัชดา, แจ้งวัฒนะ, ศรีราชา, Palacio ลาดพร้าว แจ้งวัฒนะ, Oasis อ่อนนุช, Flow มีนบุรี, Season ลาดกระบัง, พอร์ตเกต ศรีสมาน, บางนา, Kanadl รังสิต

Wize 71 : ลาดพร้าว 71

KAVE TOWN : Kave Town Space รังสิต, Kave Town Shift รังสิต, Kave Ava รังสิต, Kave TU รังสิต, Kave ศาลายา, Universe บางแสน, Town Colony, Town Island, Genesis นครปฐม, Town Island, Kavalon Seed Kaset, Embyo รังสิต คลอง 6,

The Honor : ลาดพร้าว 81, โยธินพัฒนา

ESTA : Esta Serenity อุบลราชธานี, Esta รังสิต คลอง 2

Glam : ลาดพร้าว

Jamjuree Park : รามอินทรา

Modiz : บางโพ, รามคำแหง, สุขุมวิท 50, รามคำแหง, Vault เกษตร, Aventgard, Modiz Rhyme Hill, Modiz Station-บางเขน, Sale Gallery Modiz Vault บางบัว

Modiz Launch : รังสิต

Atmoz : บางนา

แอสสิริ

บริษัท แอสสิริ จำกัด (มหาชน)

The Monument : ทองหล่อ

The Line : จตุจักร, วงษ์สว่าง

The Base : สุขุมวิท, พระราม 9, สะพานใหม่

Via : สุขุมวิท

dcondo : กำแพงแสน, ธรรมศาสตร์, เชียงใหม่, ศรีราชา

Baan sansiri : พัฒนาการ

NARASIRI : พระราม 2, บางนา, สาย 1

SETTHASIRI : แจ้งวัฒนะ, พัฒนาการ



บริษัท เอพี (ไทยแลนด์) จำกัด (มหาชน)

Vittorio : สุขุมวิท 39

The Address : สยามราชเทวี

PHYTHM : เอกมัย, สาทร, สุขุมวิท, RHYTHM เจริญกรุง

Life : สาทร, อโศก 1-3, ลาดพร้าว 1-2, วัน ไวร์เลส, สุขุมวิท 62, Life Ladprao The Valley ลาดพร้าว, Life พระราม 4, Life Asoke Hyperspace, Life สาทร เซียร์รา

Aspire : สุขุมวิท, อโศก, สาทร, เราวัณ, งามวงศ์วาน, Aspire อ่อนนุช, Aspire รัตนนิมิตร์ 3, Aspire รัชโยธิน, Aspire ปิ่นเกล้า อรุณอมรินทร์, Aspire Arun Preve

The Palazzo : พระราม 3, ราชพฤกษ์, จรัญสนิทวงศ์

CLASSE : เอกมัยรามอินทรา

SOUL : รัชดา, ลาดพร้าว

บ้านกลางเมือง : พระราม 9, อ่อนนุช, วิภาวดี-แจ้งวัฒนะ, คลาสเซ่ สุขุมวิท 77, ลาดพร้าว 101 สดชื่น, พหลโยธิน - วิภาวดี

Centro : มหาเจษฎาบดินทร์, จตุจักร, อ่อนนุช, ราชพฤกษ์

City : ราชพฤกษ์, รัชดา, สาทร, ปิ่นเกล้า

อภิทาวน์ : อยุธยา, สุพรรณบุรี, นครปฐม, สุราษฎร์ธานี

GRAND PLENO : วัชรพล-จตุจักร, บางใหญ่, รามอินทรา 117, เพิ่มสิน 28, ปิ่นเกล้า-กาญจนาฯ, เมกา-บางนา, รามอินทรา - วงแหวน 2, สุขสวัสดิ์ 64

PLENO TOWN : ทิวานนท์-รังสิต, ปิ่นเกล้า-กาญจนาฯ, ประชาอุทิศ 90, สุขุมวิท-บางปู, พหลโยธิน วิภาวดี รังสิต, พหลโยธิน-ลำลูกกา, เวสเกต, พระราม 2, วงแหวน-รังสิตคลอง 7, รังสิตคลอง 4 -วงแหวน

Pleno : พหลโยธิน, สุขสวัสดิ์พระราม 3, ปัญญา - รามอินทรา, ประชาอุทิศ-สุขสวัสดิ์, วิภาวดี-ดอนเมือง, ดอนเมือง, วิภาวดี-รังสิต, ทิวานนท์-แจ้งวัฒนะ 2, บางนา-เทพารักษ์ กรุงเทพฯ 3, รามอินทรา แฟชั่น



THE
ERAWAN
GROUP

บริษัท ที เอราวัณ กรุ๊ป จำกัด (มหาชน)

Holiday Inn

PROJECT REFERENCE

RESIDENTIAL COMPLEX



บริษัท ออริจิ้น พร็อพเพอร์ตี้ จำกัด (มหาชน)

Park Origin : ทองหล่อ, พญาไท

Knightsbridge : สุขุมวิท, รัชโยธิน, สาธ

Knightsbridge Space : รัชโยธิน, พระราม 9

Kensington : สุขุมวิท, พหล-เกษตร, ศรีราชา, สะพานใหม่

Notting Hill : สุขุมวิท, สะพานใหม่

Britania : ศรีนครินทร์, เมกะบางนา, หทัยราษฎร์

บริกซ์ตัน : ระยอง

ออริจิ้น เพลย์ : ศรีอุดม, บางขุนนนท์

The Origin : รามอินทรา 83, รามคำแหง209, สุขุมวิท 105, สายลวด, ขอนแก่น, ลาดพร้าว111

Knightsbridge Space : พระราม 4

ออริจิ้น พลิก แอนด์ เพลย์ : รามอินทรา,รามคำแหง

โซโก้ แบงค็อก : รัชดา



CRAFT a life you love

บริษัท บริทานเนีย จำกัด (มหาชน)

บริทานเนีย : สายไหม – คูคต สตชัน, เวสต์เกต, ประชาอุทิศ 90, โขม บางนา กม.17, ราชพฤกษ์ กาญจนภิเษก, ราชพฤกษ์ 345, บางนา กม.39, โขม บางนา บางปะกง, บางนา-เทพารักษ์, บางนา ศรีวารี, วงแหวน -เทพารักษ์, อุดรยา, อุดรชฎี, ระยอง, วงแหวน ปิ่นเกล้า, แพรกษา, อมตะ พานทอง, ทิวาพันธ์ ราชพฤกษ์, บางนา กม.26, ทาวน์ บางนา กม.17, ราชพฤกษ์ นครินทร์, บางนา กม.42

แกรนด์ บริทานเนีย : ทวีวัฒนา, สุขสวัสดิ์-วงแหวน, บางนา - บางพลี, ราชพฤกษ์ พระราม 5, ราชพฤกษ์ - แจ้งวัฒนะ, พระราม 9 - กรุงเทพมหานคร, คูคต สตชัน, มนทบุรี สตชัน, บางนา - สุวรรณภูมิ, วงแหวน รามอินทรา

เบลกราวี เอ็กซ์คลูซีฟ พูลวิลล่า : บางนา-พระราม 9

Belgravia : ราชพฤกษ์-นครินทร์

Belgravia Exclusive : ปิ่นเกล้า-บรมราชชนนี

ไวรตัน : บางปะกง, บางนา กม.26,คูคต สตชัน, อมตะ-สุขประยูร



บริษัท เอสซี แอสเสท คอร์ปอเรชั่น จำกัด (มหาชน)

The Crest Santora : หัวหิน

The Crest : สุขุมวิท 49

CENTRIC : รัชโยธิน, ห้วยขวาง, สาธ

GRANADA : ปิ่นเกล้า

The Gentry : สุขุมวิท, เอกมัย, พัฒนาการ, พระราม 9
เกษตร-นวมินทร์

Grand : สาทร, พระราม 9, เสรีไทย,ราชพฤกษ์จรัญ, สุขุมวิทลาซาล

Grand Bangkok Boulevard : แจ้งวัฒนะ-ราชพฤกษ์, พระราม 9,
ปิ่นเกล้า - กาญจน, บางนา-อ่อนนุช,
กรุงเทพกรีฑา,สเทท บางนา

Bangkok Boulevard : เสรีไทย, แจ้งวัฒนะ 1-2, บางนา กม12,
ปิ่นเกล้า-เพชรเกษม (สาย4), ศรีนครินทร์ บางนา,
สาทร-ราชพฤกษ์(บางซื่อคหัง), สาทร-ปิ่นเกล้า,
วิภาวดี-พหลโยธิน, ราชพฤกษ์-ปิ่นเกล้า,
ดอนเมือง-แจ้งวัฒนะ

Bangkok Boulevard Signature : ปิ่นเกล้า-บรมฯ, พระราม 2,
สาทร-ราชพฤกษ์, เวสต์เกต,
รามอินทรา-พระยาสุเรนทร์,
ลาดพร้าว-เสรีไทย

Life Bangkok Boulevard : ราชพฤกษ์-รัตนานิเบส

Venue : เวสต์เกต, ทิวาพันธ์, เวนิว ไอดี รังสิต-ปทุมธานี, พระราม 5,
เวนิวไอดี พหลโยธิน-รังสิต, เวนิว ไอดี เพชรเกษม 81,
เวนิว ไอดี รามอินทรา-มีนบุรี

PAVE : ฉะเชิงเทรา, รังสิต, รามอินทรา, ปิ่นเกล้า, ประชาอุทิศ,
เพชรเกษม- สาย4

V Compound : ราชพฤกษ์

Verve : รามคำแหง-วงแหวน, เพชรเกษม81, พระราม 5



บริษัท ดี เออเบิล พร็อพเพอร์ตี้ จำกัด

ACOLIN : ชีรีน พระราม2-ท่าข้าม

SAVVI : พหล - อารีย์

AERAS : พักยา

PROJECT REFERENCE

RESIDENTIAL COMPLEX

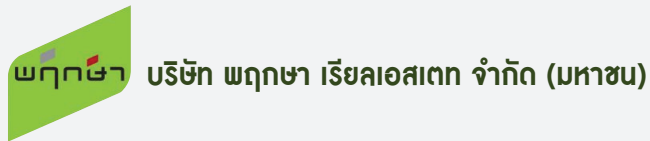

The Privacy : จตุจักร, ท่าพระ, พระราม 9
Chapter : จุฬา, ทองหล่อ
The Tree : สุขุมวิท, ลาดพร้าว, จรัญ
Plum Condo : รัชสิต, สตวรรษ (บางใหญ่), พระราม 2, สุขุมวิท 97.1
Passorn : รัชสิต, งามคำแหง, สงปรภา, ราชพฤกษ์
บ้านพุกผา : สาย 5, นครปฐม, บางคูวัด
The Connect : รัชสิต, คูบอน, บางนา, พระราม 9
Pruksa Ville : สายไหม, ปทุมธานี
The Plant : เทพารักษ์, พหลโยธิน

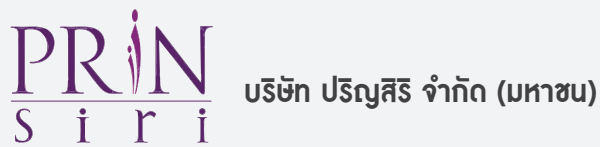

Zerene : ซัน พระราม2-ท่าข้าม
Iconature : อีคอนเนเจอร์ พระราม2-เทียนทะเล
Foret : ฟอว์เร่ ลำลูกกา-คลอง 5
Corazon : ประชาชื่น
City Sense : ซิตี้เซนส์ พระราม2-ท่าข้าม, ซิตี้เซนส์ รัชสิต
Zelle : เซล รัตนาธิเบศร, เซล รัตนาธิเบศร์ 2, เซล ศาลายา



ESCENT : อุบลราชธานี, ขอนแก่น, เชียงใหม่, นครราชสีมา, เชียงราย, อุดรธา
บ้านนิรติ : บางพลี, นครปฐม, เมืองนครศรีธรรมราช, แจ้งวัฒนะ, ดอนเมือง
Phyll : พหลโยธิน
Niyham : บรมราชธานี
นินญา : บางแค, ปากเกร็ด
บ้านนิรดา : แจ้งวัฒนะ
เอสเซ็นท์ ทาวน์ : เมืองพินบุรีโลก



บริษัท ชิวาทัย จำกัด (มหาชน)

HALLMARK : งามวงศ์วาน, แจ้งวัฒนะ
CHEWA HOME : สุขสวัสดิ์, ลำลูกกา
CHEWAWAN : ปิ่นเกล้า-สาธ, รัชสิต
ชิวารมย์ ราชพฤกษ์ ตัดใหม่ : อำเภอเมืองปทุมธานี



บริษัท อนันดา ดีเวลลอปเม้นท์ จำกัด (มหาชน)

Ashton : อโศก-พระราม 9
Ideo Q : สุขุมวิท 36
UNiO : สุขุมวิท 72
ELIO DEL-NEST : บางนา
Artale Asoke : พระราม9
UNIO Town : สวนหลวง



บริษัท เรียวออสเตท ดีเวลลอปเม้นท์ จำกัด

PLEX BANGNA : บางนา
Cascade Bangna : บางนา
The Pretium Bangna : บางนา
VIVALDI BANGNA : บางพลี
วิวัฒนา : บางนา - สุวรรณภูมิ



บริษัท อัลติจูด ดีเวลลอปเม้นท์ จำกัด

Altitude Prove : เกษตรนวมิน, พระราม 9
Unicorn : ตลาดพลู
Kraft : บางนา
Symphony : เจริญกรุง
Forest : อ่อนนุช, รัชดา

PROJECT REFERENCE

RESIDENTIAL COMPLEX



ลีโอ
พรีอเพอर्टี้

บริษัท ลีโอพรีอเพอर्टี้ จำกัด (มหาชน)

Lio : เพชรเกษม , บางพูน , รังสิต , ปิ่นเกล้า ราชบุรี , อมตะ,
กาญจนาภิเษก, สาย 4

Lanceo Crib : บางปลา , คลอง 2 , แก้วอินทร์

บ้านลิลิ : คลอง 2, ราชบุรี, บางพลี



บริษัท เมเจอร์ ดีเวลลอปเม้นท์ จำกัด (มหาชน)

Metris : ลาดพร้าว, พระราม 9, พัฒนาการ 12

Maestro : รัชดา, สาทร, ราชเทวี

M Thonglor10 : ทองหล่อ, จตุจักร

มิคฟอร์ด : ลาดพร้าว-รามคำแหง

PROPERTY PERFECT

บริษัท พร็อพเพอर्टี้ เพอร์เฟก จำกัด (มหาชน)

Bella Monte : ชาติใหญ่

Bella Costa : หัวหิน

Metro Sky : ประชาชื่น

The Sky : สุขุมวิท

Metroluxe : พระราม 4

Condo : สุขุมวิท, ศาลายา

Perfect Masterpiece : แจ้งวัฒนะ, รัตนาธิเบศร์, พระราม 9

Perfect Place : รัตนาธิเบศร์, ราชพฤกษ์, รามคำแหง

Perfect Park : ราชพฤกษ์, พระราม 5, แจ้งวัฒนะ

The Metro : พระราม 9, รัตนาธิเบศร์, เพชรเกษม 48

Modi Villa : เพชรเกษม 69, รังสิต, บางใหญ่



Q House

บริษัท ควอลิตี้ เฮ้าส์ จำกัด (มหาชน)

TWELVE : ราชพฤกษ์

ลัดดาภิรมย์ : พระราม 2, รามคำแหง, รัตนาธิเบศร์

กาซ่า วิลล์ : พระราม 2, บางนา

GRAND UNITY

บริษัท ยูนิตี้ ดีเวลลอปเม้นท์ จำกัด

Mazarine : รัชโยธิน

Ciela : ศรีปทุม

De Lapis : จรัญ 81



บริษัท เสนาดีเวลลอปเม้นท์ จำกัด (มหาชน)

นิช : ราชพฤกษ์

ลัดดาภิรมย์ : พระราม 2, รามคำแหง, รัตนาธิเบศร์

กาซ่า วิลล์ : พระราม 2, บางนา



IDENTITY YOUR STYLE

INDOOR
CONTENT

PAGE

UVC SERIES	1-14
LED SERIES	1-14
DOWNLIGHT	1-64
FLUORESCENT	1-19
TRACKLIGHT	1-8
CEILING LAMP	1-7
EMERGENCY	1-8
DECORATE	1-18

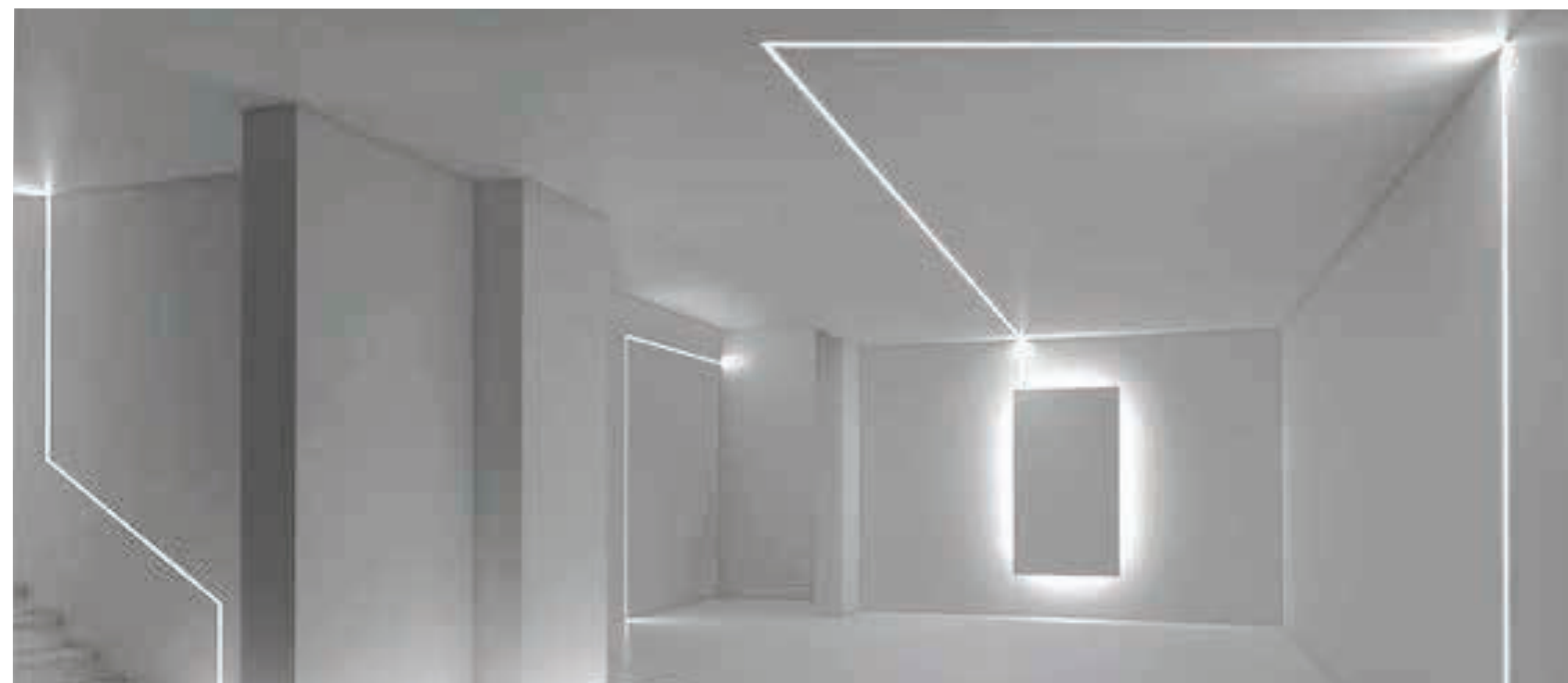

Change Your Light Keep COVID-19 at Bay



Traditional LED lighting



59S SunClean™ Lighting

59S SunClean™ Lighting is blazing the trail in integrating UV-C disinfection into LED lighting. This series of unprecedented health-protecting lighting products provide the three-fold usage of surface disinfection, air-cleaning, and illumination. Boasting a disinfection rate up to 99.9%*—with no excess radiation, no ozone produced, and no residual chemicals—and a military-grade radar sensor to detect anyone around, SunClean is designed to keep people safe and healthy.

Just change the light!

Easily prevent contamination !

Ensure the safety of family members and employees.



Restaurants



Bars



Toilets



Meeting rooms



Elevators



Gyms

Applications: restaurants, bars, barber shops, restrooms, meeting rooms, banks, gyms, elevators, hotels, clinics, nursing homes, convenience stores, supermarkets, retail stores, entertainment venues, etc.

The measurement standard of SunClean™ Lighting for killing germs



广东省微生物分析检测中心 GUANGDONG DETECTION CENTER OF MICROBIOLOGY 分析检测结果 ANALYSIS AND TEST RESULT

报告编号 (Report No.): 2020SP040R02D

1. 作用距离 Action distance: 150cm
2. 测试结果 Results:

Test organisms	Action Time	Test Group	Average cfu of testing groups (cfu/10 ⁵ piece)	Average cfu of positive controls (cfu/10 ⁵ piece)	Sterilization logarithm (KL)	Sterilization rate (%)	
<i>Staphylococcus aureus</i> ATCC 6538	150s	1	<5	3.1 × 10 ⁷	>5.79	>99.99	
		2	<5	3.0 × 10 ⁷	>5.79	>99.99	
		3	<5	3.2 × 10 ⁷	>5.81	>99.99	
		Average			>5.79	>99.99	
		30s	1	<5	3.1 × 10 ⁷	>5.79	>99.99
			2	<5	3.0 × 10 ⁷	>5.79	>99.99
	3		<5	3.2 × 10 ⁷	>5.81	>99.99	
	Average			>5.79	>99.99		
	45s		1	30	3.1 × 10 ⁷	5.19	99.99
			2	10	3.0 × 10 ⁷	5.48	99.99
		3	25	3.2 × 10 ⁷	5.11	99.99	
		Average			5.26	99.99	
		150s	1	2.6 × 10 ⁷	3.1 × 10 ⁷	4.08	99.99
			2	2.3 × 10 ⁷	3.0 × 10 ⁷	4.12	99.99
	3		2.9 × 10 ⁷	3.2 × 10 ⁷	4.05	99.99	
	Average			4.08	99.99		
	30s		1	8.2 × 10 ⁶	3.1 × 10 ⁷	3.87	99.99
			2	3.7 × 10 ⁷	3.0 × 10 ⁷	3.91	99.99
		3	4.4 × 10 ⁷	3.2 × 10 ⁷	3.87	99.99	
		Average			3.88	99.99	
		45s	1	8.3 × 10 ⁶	3.1 × 10 ⁷	3.26	99.97
			2	9.0 × 10 ⁶	3.0 × 10 ⁷	3.53	99.97
	3		9.3 × 10 ⁶	3.2 × 10 ⁷	3.53	99.97	
	Average			3.54	99.97		
75s	1		2.4 × 10 ⁷	3.1 × 10 ⁷	3.11	99.92	
	2		2.8 × 10 ⁷	3.0 × 10 ⁷	3.03	99.91	
	3	2.7 × 10 ⁷	3.2 × 10 ⁷	3.08	99.92		
	Average			3.07	99.91		

(续下表, Continued on the next page)
第 3 页 共 5 页



广东省微生物分析检测中心 GUANGDONG DETECTION CENTER OF MICROBIOLOGY 分析检测结果 ANALYSIS AND TEST RESULT

报告编号 (Report No.): 2020SP040R03D

1. 作用距离 Action distance: 150cm
2. 测试结果 Results:

Test organisms	Action Time	Test Group	Average cfu of testing groups (cfu/10 ⁵ piece)	Average cfu of positive controls (cfu/10 ⁵ piece)	Sterilization logarithm (KL)	Sterilization rate (%)	
<i>Staphylococcus aureus</i> ATCC 6538	500s	1	<5	3.1 × 10 ⁷	>5.79	>99.99	
		2	<5	3.0 × 10 ⁷	>5.79	>99.99	
		3	<5	3.2 × 10 ⁷	>5.81	>99.99	
		Average			>5.79	>99.99	
		2100s	1	<5	3.1 × 10 ⁷	>5.79	>99.99
			2	<5	3.0 × 10 ⁷	>5.79	>99.99
	3		<5	3.2 × 10 ⁷	>5.81	>99.99	
	Average			>5.79	>99.99		
	2000s		1	<5	3.1 × 10 ⁷	>5.79	>99.99
			2	<5	3.0 × 10 ⁷	>5.79	>99.99
		3	<5	3.2 × 10 ⁷	>5.81	>99.99	
		Average			>5.79	>99.99	
		1500s	1	4.5 × 10 ⁶	2.4 × 10 ⁷	3.84	99.99
			2	3.7 × 10 ⁷	2.7 × 10 ⁷	3.91	99.99
	3		4.3 × 10 ⁷	2.8 × 10 ⁷	3.88	99.99	
	Average			3.88	99.99		
	1250s		1	6.0 × 10 ⁶	2.4 × 10 ⁷	3.71	99.98
			2	5.5 × 10 ⁶	2.7 × 10 ⁷	3.54	99.98
		3	6.5 × 10 ⁶	2.8 × 10 ⁷	3.79	99.98	
		Average			3.72	99.98	
		1000s	1	8.0 × 10 ⁶	2.4 × 10 ⁷	3.59	99.97
			2	7.5 × 10 ⁶	2.7 × 10 ⁷	3.60	99.98
	3		8.0 × 10 ⁶	2.8 × 10 ⁷	3.61	99.98	
	Average			3.60	99.98		
750s	1		1.2 × 10 ⁷	2.4 × 10 ⁷	3.41	99.96	
	2		1.1 × 10 ⁷	2.7 × 10 ⁷	3.44	99.96	
	3	1.3 × 10 ⁷	2.8 × 10 ⁷	3.49	99.96		
	Average			3.42	99.96		

(续上页, Continued on the next page)
第 3 页 共 5 页



广东省微生物分析检测中心 GUANGDONG DETECTION CENTER OF MICROBIOLOGY 分析检测结果 ANALYSIS AND TEST RESULT

报告编号 (Report No.): 2020SP040R01D

1. 作用距离 Action distance: 150cm
2. 测试结果 Results:

Test organisms	Action Time	Test Group	Average cfu of testing groups (cfu/10 ⁵ piece)	Average cfu of positive controls (cfu/10 ⁵ piece)	Sterilization logarithm (KL)	Sterilization rate (%)	
<i>Escherichia coli</i> 8099	5000s	1	<5	2.4 × 10 ⁷	>5.68	>99.99	
		2	<5	2.7 × 10 ⁷	>5.73	>99.99	
		3	<5	2.8 × 10 ⁷	>5.75	>99.99	
		Average			>5.72	>99.99	
		2100s	1	<5	2.4 × 10 ⁷	>5.68	>99.99
			2	<5	2.7 × 10 ⁷	>5.73	>99.99
	3		<5	2.8 × 10 ⁷	>5.75	>99.99	
	Average			>5.72	>99.99		
	2000s		1	<5	2.4 × 10 ⁷	>5.68	>99.99
			2	<5	2.7 × 10 ⁷	>5.73	>99.99
		3	<5	2.8 × 10 ⁷	>5.75	>99.99	
		Average			>5.72	>99.99	
		1500s	1	33	2.4 × 10 ⁷	4.81	99.99
			2	33	2.7 × 10 ⁷	4.89	99.99
	3		45	2.8 × 10 ⁷	4.80	99.99	
	Average			4.84	99.99		
	1250s		1	3.2 × 10 ⁷	2.4 × 10 ⁷	3.87	99.99
			2	3.6 × 10 ⁷	2.7 × 10 ⁷	3.87	99.99
		3	3.9 × 10 ⁷	2.8 × 10 ⁷	3.86	99.99	
		Average			3.87	99.99	
		1000s	1	5.0 × 10 ⁶	2.4 × 10 ⁷	3.68	99.98
			2	5.5 × 10 ⁶	2.7 × 10 ⁷	3.69	99.98
	3		5.5 × 10 ⁶	2.8 × 10 ⁷	3.71	99.98	
	Average			3.69	99.98		
750s	1		9.0 × 10 ⁶	2.4 × 10 ⁷	3.43	99.96	
	2		8.5 × 10 ⁶	2.7 × 10 ⁷	3.45	99.96	
	3	1.0 × 10 ⁷	2.8 × 10 ⁷	3.45	99.96		
	Average			3.44	99.96		

(续上页, Continued on the next page)
第 3 页 共 5 页



广东省微生物分析检测中心 GUANGDONG DETECTION CENTER OF MICROBIOLOGY 分析检测结果 ANALYSIS AND TEST RESULT

报告编号 (Report No.): 2020SP040R01D

1. 作用距离 Action distance: 40cm
2. 测试结果 Results:

Test organisms	Action Time	Test Group	Average cfu of testing groups (cfu/10 ⁵ piece)	Average cfu of positive controls (cfu/10 ⁵ piece)	Sterilization logarithm (KL)	Sterilization rate (%)	
<i>Escherichia coli</i> 8099	160s	1	<5	2.4 × 10 ⁷	>5.68	>99.99	
		2	<5	2.7 × 10 ⁷	>5.73	>99.99	
		3	<5	2.8 × 10 ⁷	>5.75	>99.99	
		Average			>5.72	>99.99	
		80s	1	<5	2.4 × 10 ⁷	>5.68	>99.99
			2	<5	2.7 × 10 ⁷	>5.73	>99.99
	3		<5	2.8 × 10 ⁷	>5.75	>99.99	
	Average			>5.72	>99.99		
	65s		1	<5	2.4 × 10 ⁷	>5.68	>99.99
			2	<5	2.7 × 10 ⁷	>5.73	>99.99
		3	<5	2.8 × 10 ⁷	>5.75	>99.99	
		Average			>5.72	>99.99	
		40s	1	43	2.4 × 10 ⁷	4.73	99.99
			2	43	2.7 × 10 ⁷	4.62	99.99
	3		80	2.8 × 10 ⁷	4.55	99.99	
	Average			4.63	99.99		
	60s		1	1.8 × 10 ⁷	2.4 × 10 ⁷	4.12	99.99
			2	1.9 × 10 ⁷	2.7 × 10 ⁷	4.13	99.99
		3	2.1 × 10 ⁷	2.8 × 10 ⁷	4.13	99.99	
		Average			4.13	99.99	
		32s	1	2.5 × 10 ⁷	2.4 × 10 ⁷	3.90	99.99
			2	2.7 × 10 ⁷	2.7 × 10 ⁷	4.00	99.99
	3		2.8 × 10 ⁷	2.8 × 10 ⁷	4.00	99.99	
	Average			3.90	99.99		
25s	1		3.8 × 10 ⁶	2.4 × 10 ⁷	3.82	99.99	
	2		3.8 × 10 ⁶	2.7 × 10 ⁷	3.85	99.99	
	3	3.8 × 10 ⁶	2.8 × 10 ⁷	3.87	99.99		
	Average			3.83	99.99		

(续上页, Continued on the next page)
第 3 页 共 5 页

*Representative colonies: *S. aureus*, *E. coli* they are the standard representative colonies in the UV-C disinfection tests of the WHO, representing 99.9% of bacterial characteristics.

Under normal circumstances, the WHO stipulates that it is necessary to pass the test of these two kinds of bacteria, so that the disinfection ability of the UV equipment can be determined to be qualified.



Easy Installation



Safe with Human Presence



Eco Friendly



Long Lifespan



99.9% Effective

NEW PRODUCT

DESIGNED TO CREATE A SAFE SPACE

Each bar sanitizes for 30m²

การฆ่าเชื้อในอากาศเทียบเท่ากับการฟอกอากาศ 20 ครั้งต่อชั่วโมง

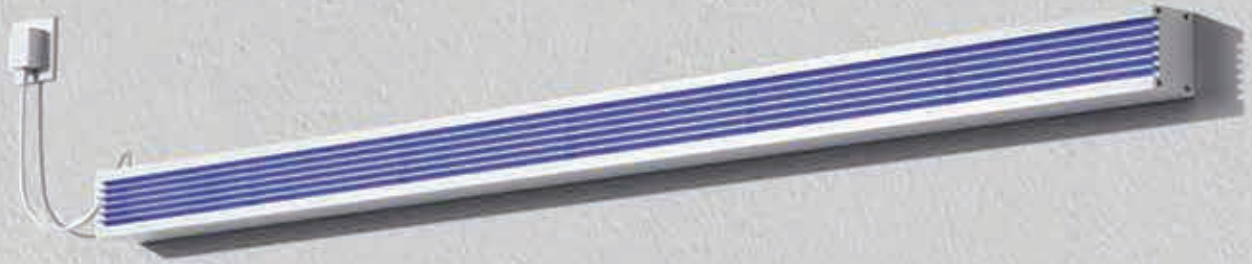

UVC-X50

SPEC.

กำลังไฟ	: 30W
พลังงาน	: 400MW
ความยาวคลื่น	: 260-280nm.
อายุการใช้งาน	: 15,000 ชั่วโมง
พื้นที่ที่เหมาะสม	: 30 ตารางเมตร
ตำแหน่งการติดตั้ง	: การติดตั้งแบบขนานสูงประมาณ 2.5 เมตร
ขนาด	: 1200 x 60 x 50mm.



การติดตั้งบนผนังขนานจากพื้น สูงประมาณ 2.5 เมตร ใช้ได้กับทุกพื้นที่ภายในอาคาร เช่น ร้านอาหาร โรงภาพยนตร์ โรงงาน สำนักงาน โรงเรียน โรงพยาบาลฯ

Application

Applicable for all indoor spaces such as restaurants, cinemas, factories, offices, schools, hospitals, cruise ships, hotels, etc.)



Office



Hospital



Restaurant



Hotel



Example for Restaurant.

SCAN ME

คุณสมบัตินสินค้า





Easy Installation



Safe with Human Presence



Eco Friendly



Long Lifespan



99.9% Effective

NEW PRODUCT

DECREASE THE AIRBORNE TRANSMISSION INDOOR

ผลิตภัณฑ์ที่มีประสิทธิภาพในการฆ่าเชื้อไวรัสและแบคทีเรีย
สำหรับช่องระบายอากาศ

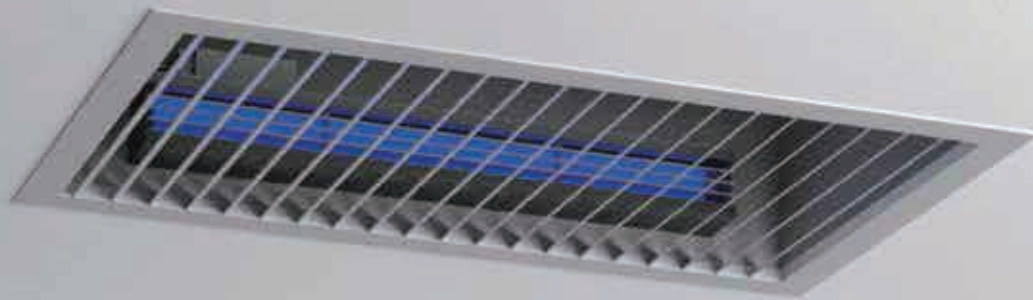

UVC-X51

SPEC.

- กำลังไฟ : 8W
- พลังงาน : 120MJ
- ความยาวคลื่น : 260-280nm.
- อายุการใช้งาน : 20,000 ชั่วโมง
- พื้นที่ที่เหมาะสม : ภายในช่องระบายอากาศ
- ขนาด : 400 x 66 x 42.8mm.

ติดตั้งง่ายภายในช่องระบายอากาศ ใช้ได้กับทุกพื้นที่ ที่มีเครื่องปรับอากาศภายในอาคาร เช่น ร้านอาหาร
โรงพยาบาล โรงเรียน สำนักงาน โรงแรม

Application

Applicable for all indoor spaces such as restaurants, cinemas, factories, offices, schools, hospitals, cruise ships, hotels, etc.)



Office



Hospital



Restaurant



Hotel



SCAN ME

คุณสมบัติสินค้า



LED SERIES

STRIPLIGHT

IP20

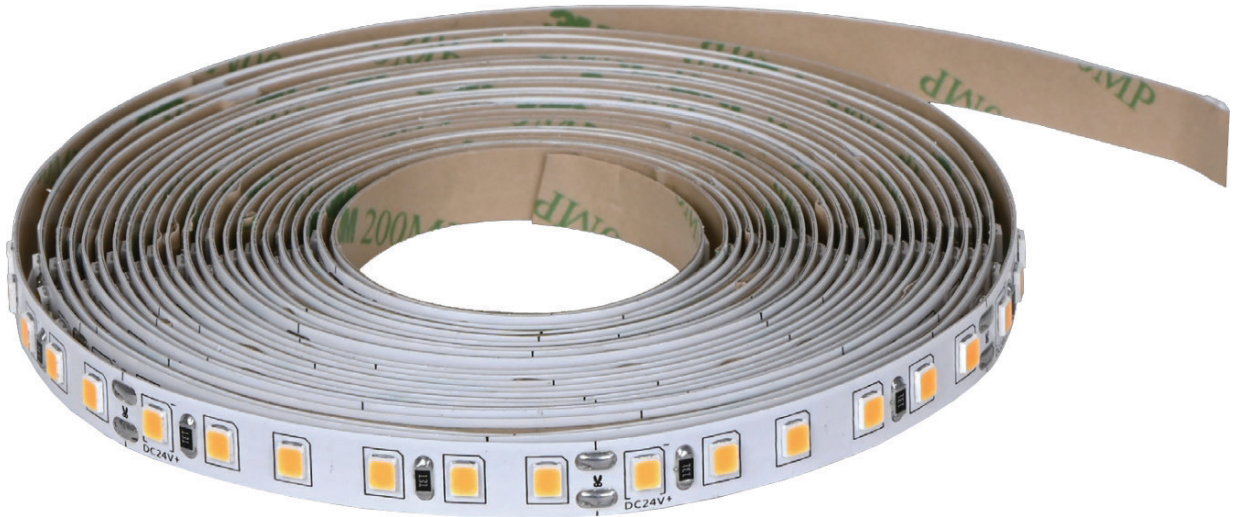
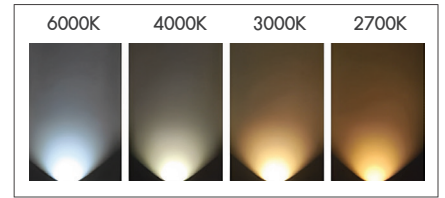

LED STRIPLIGHT

รหัสสินค้า	วัตต์	แสง	ลูเมน/วัตต์
SIM-RB20/24/8/30	24V 8W/M.	3000K	750lm/m.
SIM-RB20/24/8/40	24V 8W/M.	4000K	800lm/m.
SIM-RB20/24/8/65	24V 8W/M.	6500K	800lm/m.
SIM-RB20/24/12/30	24V 12W/M.	3000K	1150lm/m.
SIM-RB20/24/12/40	24V 12W/M.	4000K	1200lm/m.
SIM-RB20/24/12/65	24V 12W/M.	6500K	1200lm/m.

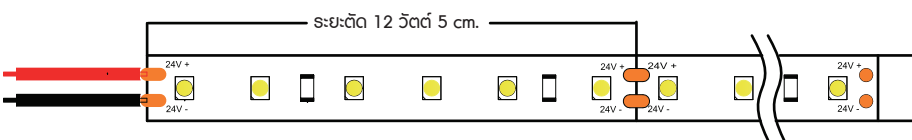
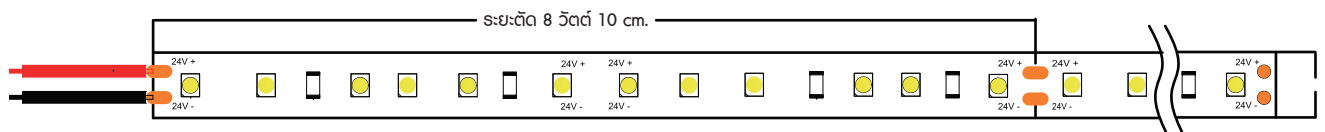

LED SERIES

STRIPLIGHT

IP65

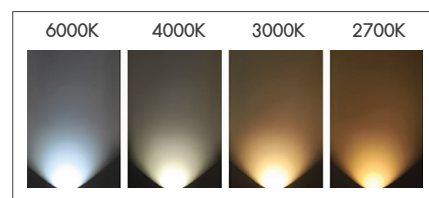

LED STRIPLIGHT

รหัสสินค้า	วัตต์	แสง	ลูเมน/วัตต์
SIM-RB65/24/5/30	24V 5W/M.	3000K	425lm/m.
SIM-RB65/24/5/35	24V 5W/M.	3500K	425lm/m.
SIM-RB65/24/5/40	24V 5W/M.	4000K	425lm/m.
SIM-RB65/24/10/30	24V 10W/M.	3000K	850lm/m.
SIM-RB65/24/10/35	24V 10W/M.	3500K	850lm/m.
SIM-RB65/24/10/40	24V 10W/M.	4000K	850lm/m.

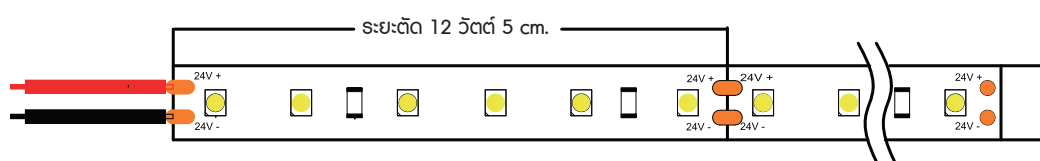

LED SERIES

STRIPLIGHT

DIMENSIONS

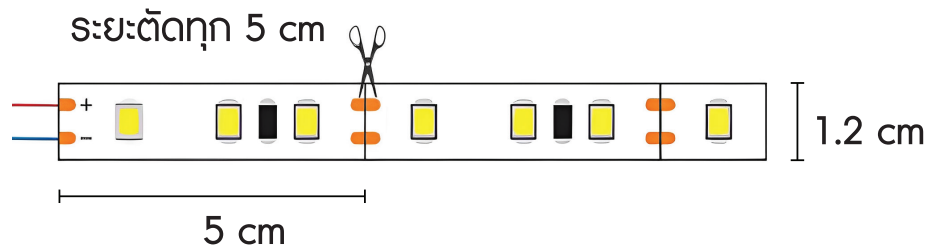

LED-RB68/8/12

Luminous : 800/m

LES Strip Light : 8W

IP Grade : IP68 (ใช้ภายนอก)

Transformer : 12VDC

2,000.-/5m.



LED-RBU65/12/24/30

Color Temperature : 3000 K

Luminous : 1200/m

LES Strip Light : 12W

IP Grade : IP67 (ใช้ภายนอก)

Transformer : 24VDC

14,000.-/10m.

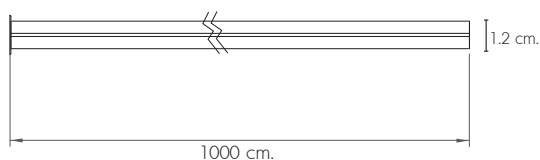

LED-RBU68-BAR1
400.-/1m.

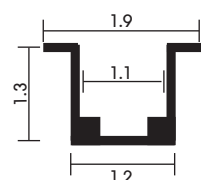

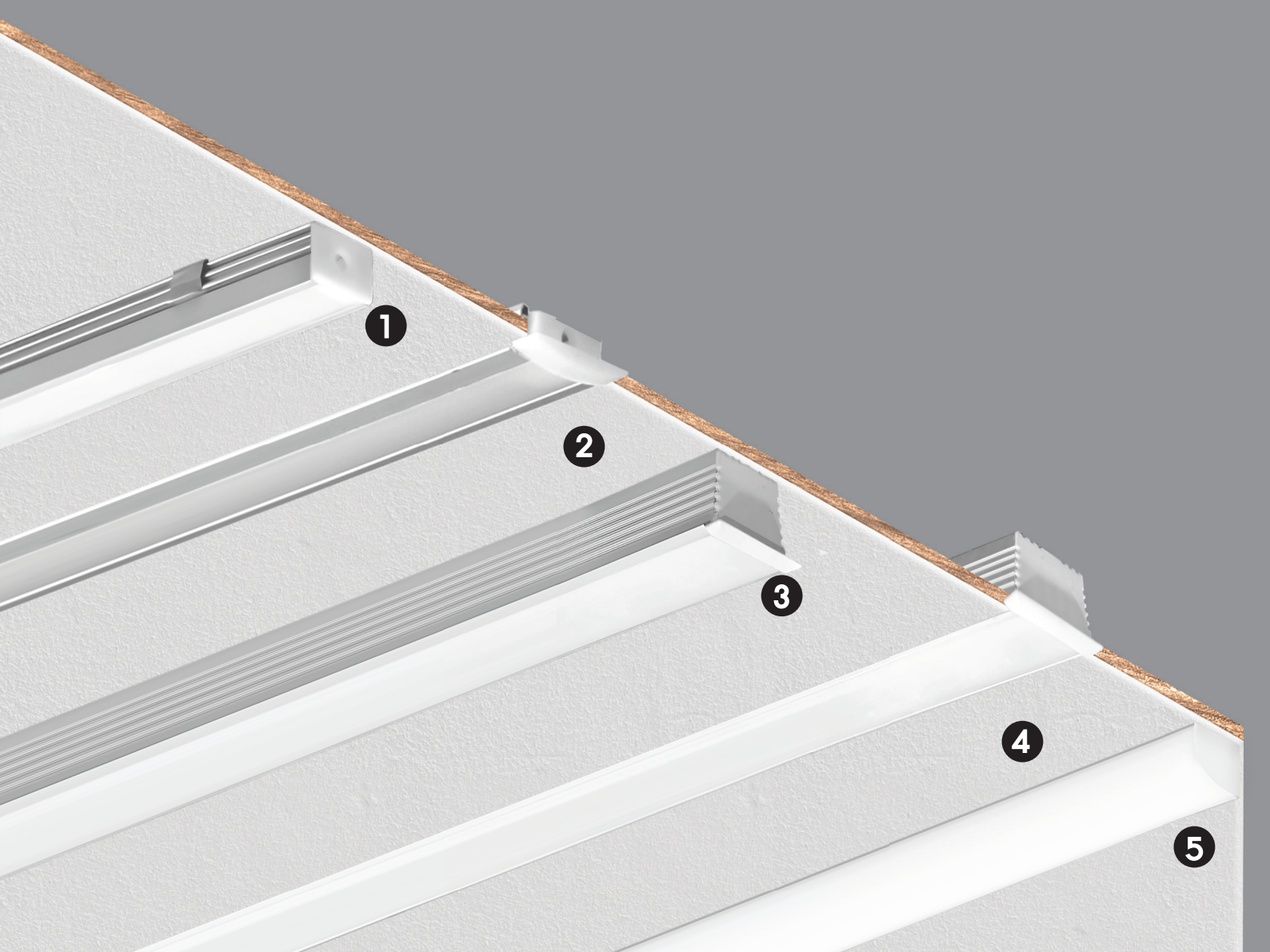

Track **Aluminium.**

for strip light & ribbon

	1	2	3	4	5
Dimension unit of cm.					
			(ใส่ LED 2 ใลู่)	(ใส่ LED 2 ใลู่)	
	1	2	3	4	5
	LED-RB-BAR-17	LED-RB-BAR-R15	LED-RB-BAR-H35	LED-RB-BAR-R35	LED-RB-BAR45
Price	200.-/1M	300.-/1M	1,500.-/2M	1,200.-/2M	300.-/1M



POWER SUPPLY & SWITCHING



LED-TRRS/12/35
(3A)

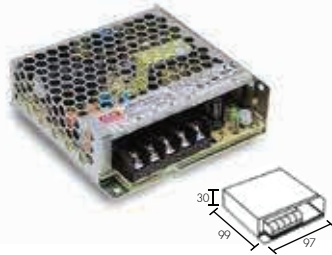

LED-TRRS/12/75
(4.2A)



LED-TRRS/12/150
(12.5A)



LED-TRRS/12/350
(29A)

IP20 12v

ID CODE	Input Voltage	Out Voltage	Output Current	Power Frequency	Output Power	Dimension (mm) L x W x H
LED-TRRS/12/35/MW	AC 85 - 264V	DC 12V	3A	47-63Hz	36w	99 x 82 x 30
LED-TRRS/12/50/MW	AC 85 - 264V	DC 12V	4.2A	47-63Hz	50.4w	99 x 82 x 36
LED-TRRS/12/75/MW	AC 85 - 264V	DC 12V	6A	47-63Hz	72w	99 x 97 x 30
LED-TRRS/12/100/MW	AC 85 - 264V	DC 12V	8.5A	47-63Hz	102w	129 x 97 x 30
LED-TRRS/12/150/MW	AC 170 - 264V	DC 12V	12.5A	47-63Hz	150w	159 x 97 x 30
LED-TRRS/12/200/MW	AC 180 - 264V	DC 12V	17A	47-63Hz	204w	215 x 115 x 30
LED-TRRS/12/350/MW	AC 180 - 264V	DC 12V	29A	47-63Hz	348w	215 x 115 x 30

IP20 24v

ID CODE	Input Voltage	Out Voltage	Output Current	Power Frequency	Output Power	Dimension (mm) L x W x H
LED-TRRS/24/35/MW	AC 85 - 264V	DC 24V	1.5A	47-63Hz	36w	99 x 82 x 30
LED-TRRS/24/50/MW	AC 85 - 264V	DC 24V	2.2A	47-63Hz	52.8w	99 x 82 x 36
LED-TRRS/24/75/MW	AC 85 - 264V	DC 24V	3.2A	47-63Hz	76.8w	99 x 97 x 30
LED-TRRS/24/100/MW	AC 85 - 264V	DC 24V	4.5A	47-63Hz	108w	129 x 97 x 30
LED-TRRS/24/150/MW	AC 170 - 264V	DC 24V	6.5A	47-63Hz	156w	159 x 97 x 30
LED-TRRS/24/200/MW	AC 180 - 264V	DC 24V	8.8A	47-63Hz	211.2w	215 x 115 x 30
LED-TRRS/24/350/MW	AC 180 - 264V	DC 24V	14.6A	47-63Hz	350.4w	215 x 115 x 30

STRIPLIGHT Collection



- Warm White 3000K
- Cool White 4000K
- Day light 6000K

คุณสมบัติ

- ใช้ Chip 5050 คุณภาพสูง
- ภายในใช้ไส้ทองแดงอย่างดี
- ห่อหุ้มด้วย เรซิน และ PVC อย่างดี
- ระดับการกันน้ำกันฝุ่น IP65

ประโยชน์

- แสงที่ออกมาเป็นระเบียบและสว่างทั่วยี่ห่อทั่วไป
- สีสันเพี้ยน
- ให้แสงสว่างคงที่ตลอดอายุการใช้งาน
- ให้ความยืดหยุ่นสูง เหมาะกับการใช้งานในหลายสถานที่

รายละเอียดสินค้า	จำนวน	Power Factor	Lumen (lm)	อายุการใช้งาน (ชั่วโมง)
OPL-RB220/30 220V 8W/m 3000K	1m.	0.9	350	12000
OPL-RB220/40 220V 8W/m 4000K	1m.	0.9	350	12000
OPL-RB220/60 220V 8W/m 6000K	1m.	0.9	350	12000
OPL-RB220/RD 220V 8W/m สีแดง	1m.	0.9	350	12000
OPL-RB220/BL 220V 8W/m สีฟ้า	1m.	0.9	350	12000
OPL-RB220/GN 220V 8W/m สีเขียว	1m.	0.9	350	12000
OPL-RB220/YM 220V 8W/m สีเหลือง	1m.	0.9	350	12000

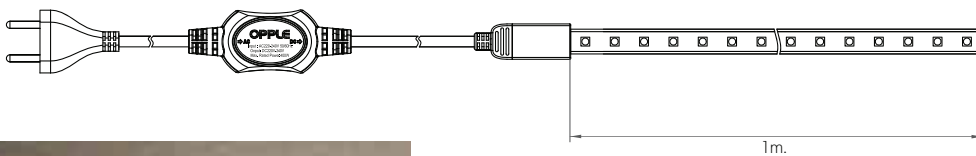

Accessory Information

LED Strip 5050 Accessory Package (ปลั๊กไฟ + อุปกรณ์)

- OPL-RB220-A1
- OPL-RB220-CAM

หัวจ่าย+จุดปิด+แคมปรับ

การใช้งานเหมาะสำหรับ

- ที่พักอาศัย
- โรงแรม
- ร้านค้าทั่วไป
- ห้างสรรพสินค้า
- สำนักงาน





T5 BATTEN

- ให้แสงสว่างแบบไร้รอยต่อ
- ประหยัด ง่ายต่อการติดตั้งและซ่อมบำรุง
- ประสิทธิภาพสูง ให้การประหยัดพลังงานที่มากกว่า

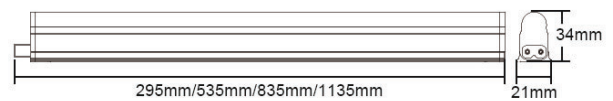

มีให้เลือกถึง 4 ขนาด 30, 60, 90 และ 120 ซม.

ชื่อรุ่น	วัตต์ (W)	อุณหภูมิแสง และ ค่าลูเมน (lm)			Beam Angle	Power Factor	ขนาด กวขยส (มม.)	จำนวน/กล่อง
		วอร์มไวท์ 3000K	คูลไวท์ 4000K	เดย์ไลท์ 6500K				
MG-FAT5-5	5	400	-	450	120°	0.5	24x370x33	20
MG-FAT5-10	10	800	-	900	120°	0.5	24x610x33	20
MG-FAT5-15	15	1200	-	1350	120°	0.5	24x910x33	20
MG-FAT5-20	20	1600	-	1800	120°	0.5	24x1210x33	20





HIGHBAY

- เหมาะสำหรับการใช้งานในโรงจอดรถ, โกดังสินค้า, และอื่นๆ
- ตัวคอมออกแบบให้ระบายความร้อนได้ดี
- อายุการใช้งานยาวนาน 25,000 ชั่วโมง
- IP65 ติดตั้งได้ทั้งภายในและภายนอกอาคาร

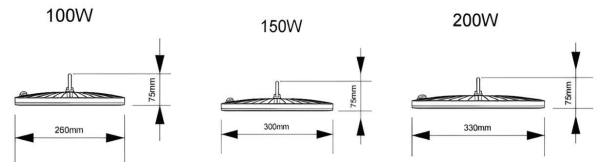

ชื่อรุ่น	วัตต์ (W)	Power Factor	ค่าลูเมน (lm)	Beam Angle	ขนาด กวขยส (มม.)	จำนวน/กล่อง
MG-HB100/65	100	0.9	10000	90°	Ø 260x75	8
MG-HB150/65	150	0.9	15000	90°	Ø 300x75	6
MG-HB200/65	200	0.9	20000	90°	Ø 330x75	4

ในชุดรวมสีขาว 1 เมตร

170-240V	CRI ≥ 80	-20~40°C	IP65	IK08	Surge Protection	6500K
----------	----------	----------	------	------	------------------	-------

MG-HB100/65 100W

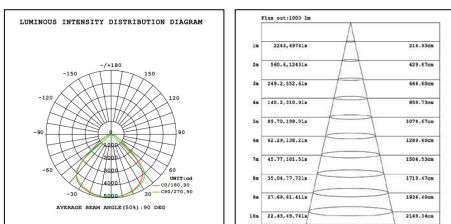

MG-HB150/65 150W

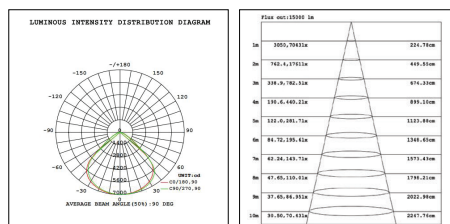

MG-HB200/65 200W

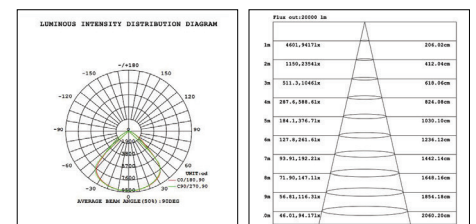



Motion Sensor
ทำงานตอนกลางคืนเมื่อมีการเดินผ่าน



WI-NIGHT/MO/BK

3W 3000K

220V

440.-

WI-NIGHT/MO/WH

3W 3000K

220V

440.-

WI-NIGHT/40/MO/BK

3W 4000K

220V

440.-



OPL-NIGHT

1W 3000K

210.-



WI-NIGHT/BK

3W 3000K

220V

590.-



WI-NIGHT/WH

3W 3000K

220V

590.-

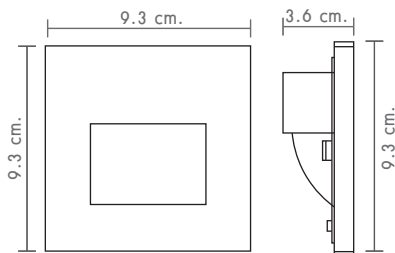

ใช้ BOX ฝังแบบ MK BOX

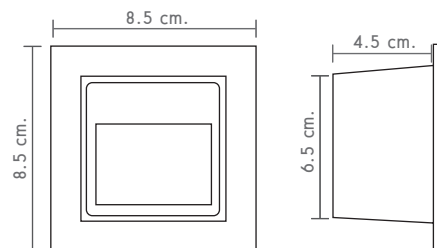

**รหัส WI-NIGHT/MO กับ WI-NIGHT ขนาดเท่ากัน



LED READING LAMP

Material: Aluminum

LED: 3W LED 3000K, U.S Cree chip+CE Driver

Switch: Yes, (metal switch)

Function: Aluminum head can be move up,down, right & left

Features: plastic slip inside to protect scratch Insert installation



WI-BOOKIE/WH
Aluminum
LED 3W 3000K
2,200.-



WI-BOOKIE/BK
Aluminum
LED 3W 3000K
2,200.-

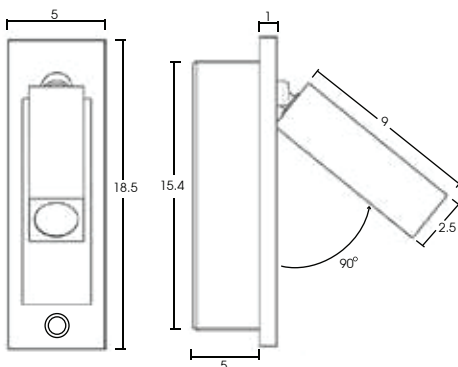



DESIGN LIGHTING
DOWNLIGHT

LED PANEL SLIM ROUND

Recess Downlight

ALUMINIUM BODY, WORKING VOLTAGE AC 85-265V, CHIP TYPE EPISTAR

LUMEN PER WATT 85-90 LM/WATT, BEAM ANGLE 120 DEG

LIFE TIME 25,000 Hrs,



พ.ก. 1955-2551



ใช้ตัวต่อแบบพิเศษไม่ต้องใช้อุปกรณ์ในการเปลี่ยน Driver ในกรณีซ่อมแซม



3000K

4000K

6000K

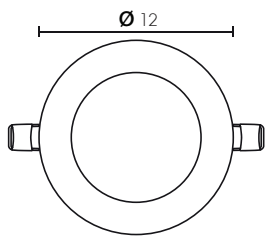

DL-PN006E/30/LTO
DL-PN006E/60/LTO
EPISTAR 2835 SMD LED CHIP
540 LM
220V, AC, 50/60HZ
126.-

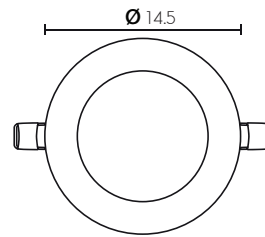

DL-PN009E/30/LTO
DL-PN009E/40/LTO
DL-PN009E/60/LTO
EPISTAR 2835 SMD LED CHIP
810 LM
220V, AC, 50/60HZ
172.-

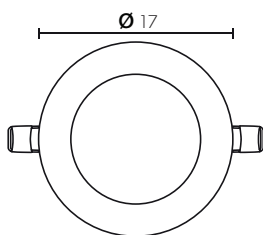

DL-PN012E/30/LTO
DL-PN012E/40/LTO
DL-PN012E/60/LTO
EPISTAR 2835 SMD LED CHIP
1080 LM
220V, AC, 50/60HZ
210.-

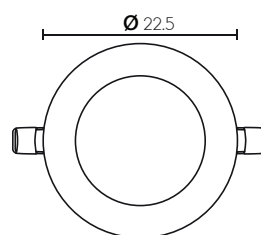

DL-PN018E/30/LTO
DL-PN018E/40/LTO
DL-PN018E/60/LTO
EPISTAR 2835 SMD LED CHIP
1620 LM
220V, AC, 50/60HZ
324.-



LED PANEL SLIM SQUARE

Recess Downlight

ALUMINIUM BODY, WORKING VOLTAGE AC 85-265V, CHIP TYPE EPISTAR

LUMEN PER WATT 85-90 LM/WATT, BEAM ANGLE 120 DEG

LIFE TIME 25,000 Hrs.



มอก. 1955-2551



ใช้ตัวต่อแบบพิเศษไม่ต้องใช้อุปกรณ์ในการเปลี่ยน Driver ในทรานซ์ฟอร์มเมอร์



3000K

4000K

6000K

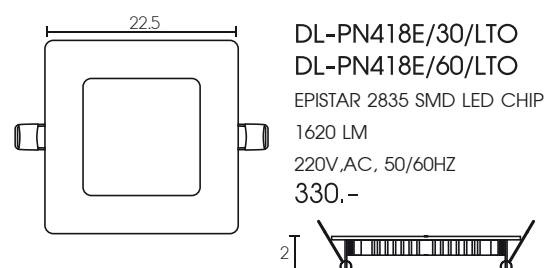
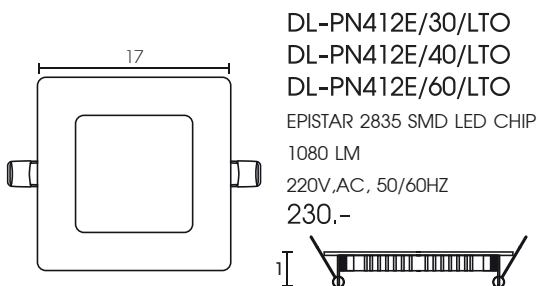
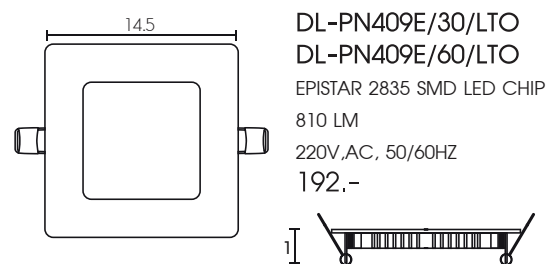
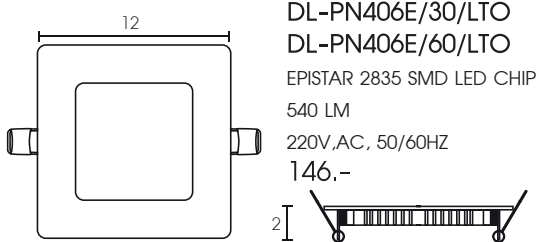

LED PANEL SLIM ROUND

Surface Downlight

ALUMINIUM BODY, WORKING VOLTAGE AC 85-265V, CHIP TYPE EPISTAR

LUMEN PER WATT 85-90 LM/WATT, BEAM ANGLE 120 DEG

LIFE TIME 25,000 Hrs.



มอก. 1955-2551



ใช้ตัวต่อแบบพิเศษไม่ต้องใช้อุปกรณ์ในการเปลี่ยน Driver ในการซ่อมแซม

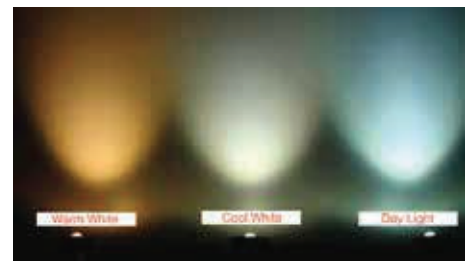

3000K

4000K

6000K

DB-PNS06E/30/LTO
DB-PNS06E/60/LTO
EPISTAR 2835 SMD LED CHIP
540 LM
220V,AC, 50/60HZ
180.-

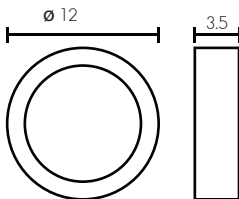

DB-PNS012E/30/LTO
DB-PNS012E/60/LTO
EPISTAR 2835 SMD LED CHIP
1080 LM
220V,AC, 50/60HZ
250.-

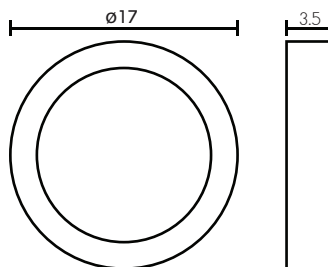

DB-PNS018E/30/LTO
DB-PNS018E/40/LTO
DB-PNS018E/60/LTO
EPISTAR 2835 SMD LED CHIP
1620 LM
220V,AC, 50/60HZ
350.-

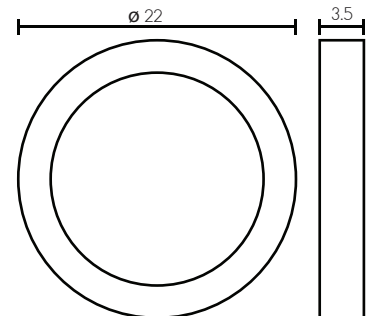

LED PANEL SLIM SQUARE

Surface Downlight

ALUMINIUM BODY, WORKING VOLTAGE AC 85-265V, CHIP TYPE EPISTAR

LUMEN PER WATT 85-90 LM/WATT, BEAM ANGLE 120 DEG

LIFE TIME 25,000 Hrs.



พฉก. 1955-2551



ใช้ตัวต่อแบบพิเศษไม่ต้องไขว่ปลั๊กกรณีในการเปลี่ยน Driver ในรุ่นซ่อนเขา



3000K

4000K

6000K

DB-PNS406E/30/LTO
DB-PNS406E/40/LTO
DB-PNS406E/60/LTO
EPISTAR 2835 SMD LED CHIP
540 LM
220V.AC, 50/60HZ
220,-

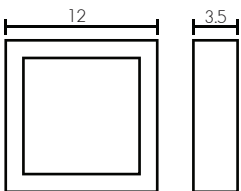

DB-PNS412E/30/LTO
DB-PNS412E/60/LTO
EPISTAR 2835 SMD LED CHIP
1080 LM
220V.AC, 50/60HZ
300,-

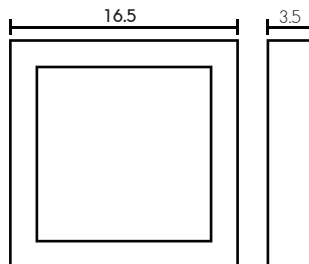

DB-PNS418E/30/LTO
DB-PNS418E/40/LTO
DB-PNS418E/60/LTO
EPISTAR 2835 SMD LED CHIP
1620 LM
220V.AC, 50/60HZ
440,-

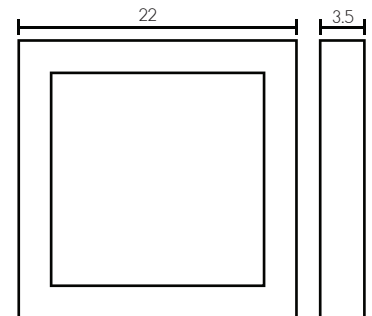



LED PANEL SLIM DIMMABLE

Recess Downlight

ALUMINIUM BODY, WORKING VOLTAGE AC 85-265V, CHIP TYPE EPISTAR

LUMEN PER WATT 85-90 LM/WATT, BEAM ANGLE 120 DEG

LIFE TIME 25,000 Hrs,



พ.ร.บ. 1955-2551



****ปรับไฟหรือไฟได้**



DL-PN009W/DIM/LTO

EPISTAR 2835 SMD LED CHIP

720 LM DIMMABLE

220V.AC, 50/60HZ

400.-

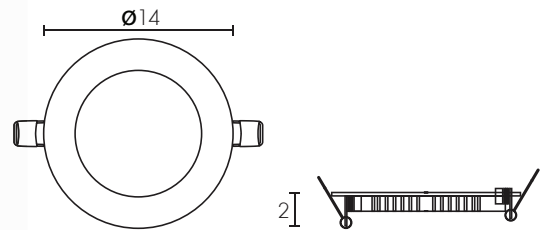

DL-PN409W/DIM/LTO

EPISTAR 2835 SMD LED CHIP

720 LM DIMMABLE

220V.AC, 50/60HZ

400.-

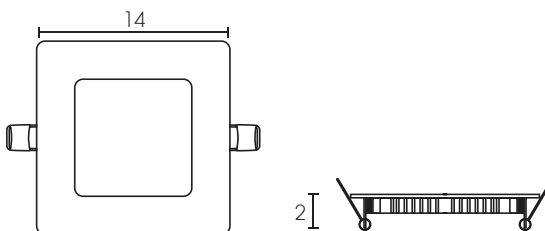

LED PANEL SLIM ROUND

Recess Downlight

ALUMINIUM BODY, WORKING VOLTAGE AC 85-265V, CHIP TYPE EPISTAR

LUMEN PER WATT 75 LM/WATT, BEAM ANGLE 120 DEG

LIFE TIME 25,000 Hrs,



พ.ศ. 1955-2551

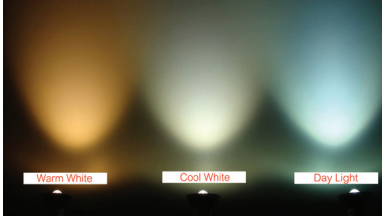

3000K

4000K

6000K



DL-PNH012/30/LTO
DL-PNH012/40/LTO
DL-PNH012/60/LTO
EPISTAR 2835 SMD LED CHIP
960 LM.
280,-

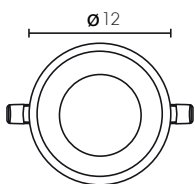

DL-PNH018/30/LTO
DL-PNH018/40/LTO
DL-PNH018/60/LTO
EPISTAR 2835 SMD LED CHIP
1440 LM
400,-

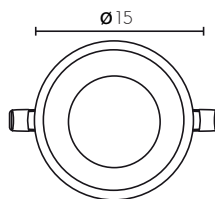

DL-PNH024/30/LTO
DL-PNH024/40/LTO
DL-PNH024/60/LTO
EPISTAR 2835 SMD LED CHIP
1920 LM
480,-

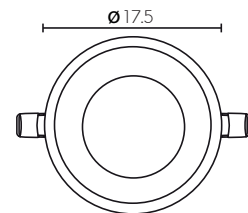

LED PANEL SLIM SQUARE

Recess Downlight

ALUMINIUM BODY, WORKING VOLTAGE AC 85-265V, CHIP TYPE EPISTAR

LUMEN PER WATT 75 LM/WATT, BEAM ANGLE 120 DEG

LIFE TIME 25,000 Hrs,



พ.น. 1955-2551

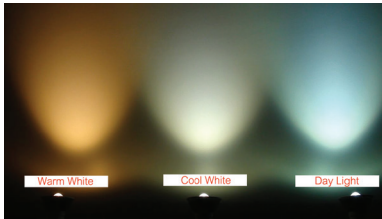

3000K

4000K

6000K



DL-PNH412/30/LTO
DL-PNH412/40/LTO
DL-PNH412/60/LTO
EPISTAR 2835 SMD LED CHIP
960 LM
300.-

DL-PNH418/30/LTO
DL-PNH418/40/LTO
DL-PNH418/60/LTO
EPISTAR 2835 SMD LED CHIP
1440 LM
420.-

DL-PNH424/30/LTO
DL-PNH424/40/LTO
DL-PNH424/60/LTO
EPISTAR 2835 SMD LED CHIP
1920 LM
500.-

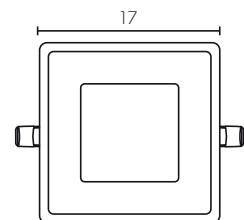
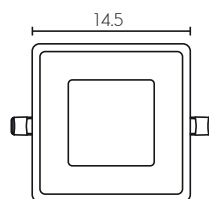
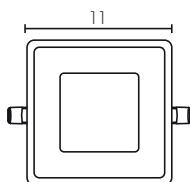

LED PANEL SLIM ROUND

Recess Downlight

ALUMINIUM BODY, WORKING VOLTAGE AC 85-265V, CHIP TYPE EPISTAR

LUMEN PER WATT 90-100 LM/WATT, BEAM ANGLE 120 DEG

LIFE TIME 25,000 Hrs.

รุ่นขอบเล็ก
เพียง 5 มม.

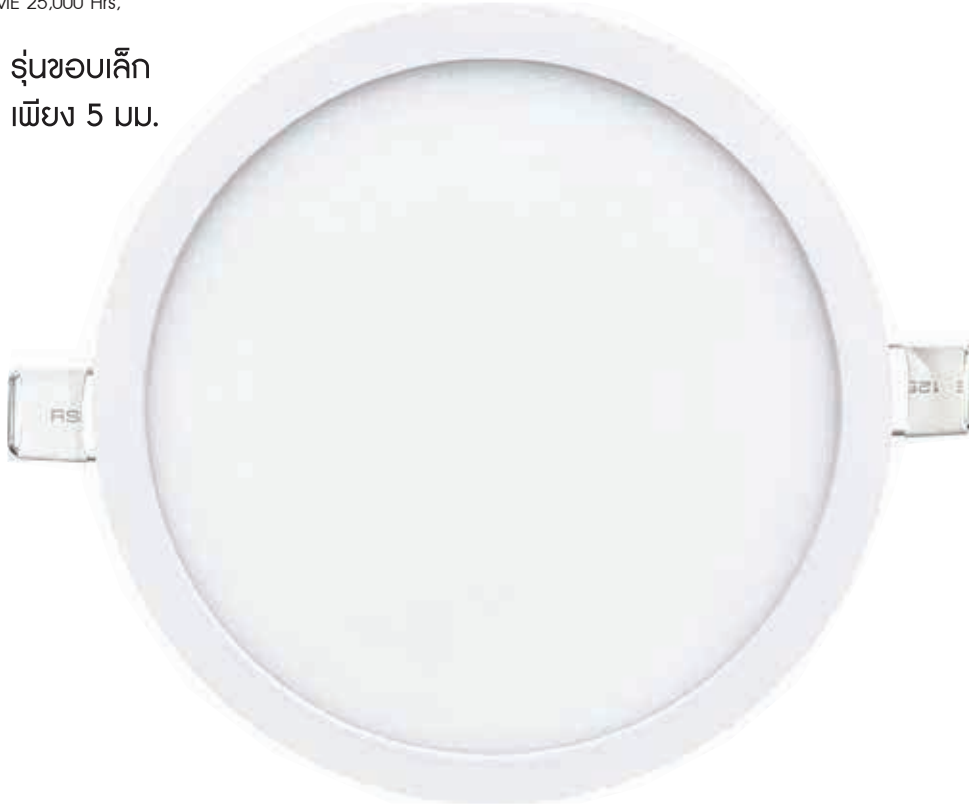

มอก. 1955-2551

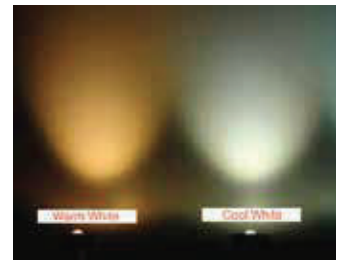

3000K

4000K

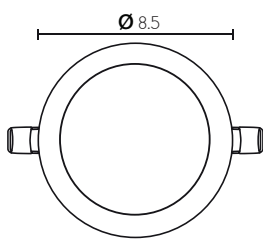

DL-PN6-06/30/LTO
DL-PN6-06/40/LTO
EPISTAR 2835 SMD LED CHIP
540 LM
220V.AC, 50/60HZ
180.-

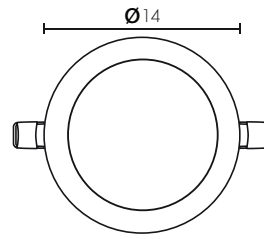

DL-PN6-12/30/LTO
DL-PN6-12/40/LTO
EPISTAR 2835 SMD LED CHIP
1080 LM
220V.AC, 50/60HZ
310.-

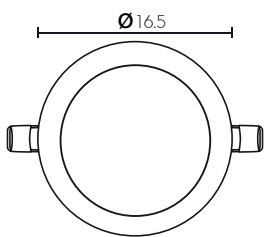

DL-PN6-18/30/LTO
DL-PN6-18/40/LTO
EPISTAR 2835 SMD LED CHIP
1620 LM
220V.AC, 50/60HZ
400.-

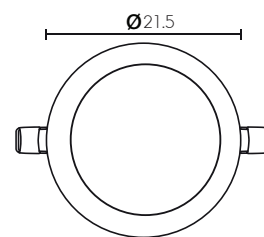

DL-PN6-24/30/LTO
DL-PN6-24/40/LTO
EPISTAR 2835 SMD LED CHIP
2160 LM
220V.AC, 50/60HZ
580.-



LED PANEL SLIM ROUND

Recess Downlight

ALUMINIUM BODY, WORKING VOLTAGE AC 85-265V, CHIP TYPE EPISTAR

LUMEN PER WATT 90-100 LM/WATT, BEAM ANGLE 120 DEG

LIFE TIME 25,000 Hrs,

รุ่นขอบเล็ก
เพียง 5 มม.



พ.ฉ. 1955-2551

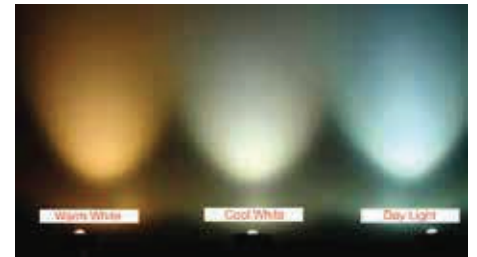

3000K

4000K

6000K

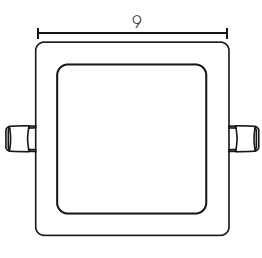

DL-PN7-06/30/LTO
DL-PN7-06/40/LTO
EPISTAR 2835 SMD LED CHIP
540 LM
220V, AC, 50/60HZ
190,-

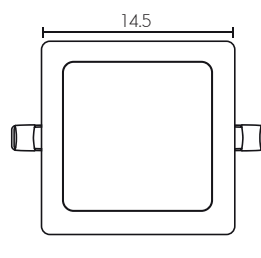

DL-PN7-12/30/LTO
DL-PN7-12/40/LTO
EPISTAR 2835 SMD LED CHIP
1080 LM
220V, AC, 50/60HZ
310,-

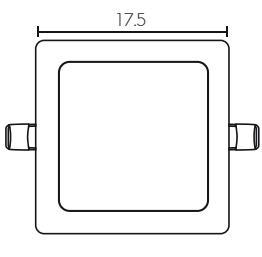

DL-PN7-18/30/LTO
DL-PN7-18/40/LTO
EPISTAR 2835 SMD LED CHIP
1620 LM
220V, AC, 50/60HZ
440,-

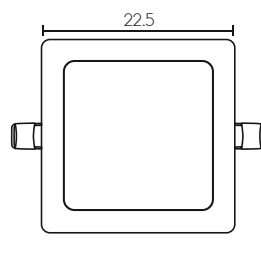

DL-PN7-24/30/LTO
DL-PN7-24/40/LTO
EPISTAR 2835 SMD LED CHIP
2160 LM
220V, AC, 50/60HZ
580,-



DOWNLIGHT

- ติดตั้งง่าย เหมาะสำหรับการใช้งานภายในอาคาร
- อายุการใช้งานยาวนาน 15,000 ชั่วโมง
- การเรียงเม็ดแอลอีดีแบบ Backlit ทำให้ได้แสงสว่างอย่างสม่ำเสมอและแสงกระจายออกมาอย่างเต็มประสิทธิภาพ



ในกรณีที่ใช้เป็นพาแนลติดลอย
สามารถซื้อกล่องลอยเพิ่มได้



170-240V	CRI ≥80	-20~40°C	IP40	IK02	3000K/4000K/6500K
----------	---------	----------	------	------	-------------------

ชื่อรุ่น	วัตต์ (W)	Power Factor	ค่าลูเมน (lm)	Beam Angle	ขนาด กวขยศ (มม.)	จำนวน/กล่อง
MG-PN007/30	7	0.5	490	120°	Ø110x30	100
MG-PN007/40	7	0.5	525	120°	Ø110x30	100
MG-PN007/65	7	0.5	525	120°	Ø110x30	100
MG-PN009/30	9	0.5	675	120°	Ø125x30	80
MG-PN009/40	9	0.5	720	120°	Ø125x30	80
MG-PN009/65	9	0.5	720	120°	Ø125x30	80
MG-PN012/30	12	0.5	900	120°	Ø145x30	60
MG-PN012/40	12	0.5	960	120°	Ø145x30	60
MG-PN012/65	12	0.5	960	120°	Ø145x30	60
MG-PN015/30	15	0.5	1200	120°	Ø175x30	60
MG-PN015/40	15	0.5	1350	120°	Ø175x30	60
MG-PN015/65	15	0.5	1350	120°	Ø175x30	60
MG-PN024/30	24	0.5	1920	120°	Ø225x30	40
MG-PN024/65	24	0.5	2160	120°	Ø225x30	40

DOWNLIGHT

- ติดตั้งง่าย เหมาะสำหรับการใช้งานภายในอาคาร
- อายุการใช้งานยาวนาน 15,000 ชั่วโมง
- การเรียงเม็ดแอลอีดีแบบ Backlit ทำให้ได้แสงสว่างอย่างสม่ำเสมอและแสงกระจายออกอย่างเต็มประสิทธิภาพ



ในกรณีที่ใช้เป็นพาแนลติดลอย
สามารถซื้อกล่องลอยเพิ่มได้



170-240V	CRI ≥ 80	-20~40°C	IP40	IK02	3000K/4000K/6500K
----------	----------	----------	------	------	-------------------

ชื่อรุ่น	วัตต์ (W)	Power Factor	ค่าลูเมน (lm)	Beam Angle	ขนาด กวขยส (มม.)	จำนวน/กล่อง
MG-PN409/30	9	0.5	675	120°	∅125x30	80
MG-PN409/40	9	0.5	720	120°	∅125x30	80
MG-PN409/65	9	0.5	720	120°	∅125x30	80
MG-PN412/30	12	0.5	900	120°	∅145x30	60
MG-PN412/40	12	0.5	960	120°	∅145x30	60
MG-PN412/65	12	0.5	960	120°	∅145x30	60
MG-PN415/30	15	0.5	1200	120°	∅175x30	60
MG-PN415/40	15	0.5	1350	120°	∅175x30	60
MG-PN415/65	15	0.5	1350	120°	∅175x30	60
MG-PN424/30	24	0.5	1920	120°	∅225x30	40
MG-PN424/65	24	0.5	2160	120°	∅225x30	40

DOWNLIGHT

- ไตรเวอร์ DOB IC การออกแบบแบบบูรณาการ ติดตั้งและเดินสายได้ง่าย
- รูปทรงบางพิเศษ เรียบง่ายและสวยงาม
- ขนาดหลากหลาย ดีไซน์เป็นซีรีส์ครบชุด
- ไฟส่องสว่างด้านหลัง กระจายแสงสม่ำเสมอ ไม่มีจุดมืด
- ชิป LED ประสิทธิภาพสูง ให้ความสว่างมาก ประหยัดพลังงาน และแสงเสื่อมช้า
- ปราศจากการกะพริบ ช่วยถนอมสายตาได้อย่างมีประสิทธิภาพ
- ไม่มีรังสี UV และอินฟราเรด ปกป้องจากปรอท เป็นมิตรต่อสิ่งแวดล้อม



170-240V	CRI ≥ 80	-20~40°C	IP20	IK02	3000K/4000K/6500K
----------	----------	----------	------	------	-------------------

Model	Power	Color Temperature TK	Voltage	PF	Luminous Flux	Product Size
MG-DB-PNS012/30	12W	3000K	170-240V	0.5	720lm	Ø120*40mm
MG-DB-PNS012/40	12W	4000K	170-240V	0.5	720lm	Ø120*40mm
MG-DB-PNS012/65	12W	6500K	170-240V	0.5	720lm	Ø120*40mm
MG-DB-PNS018/30	18W	3000K	170-240V	0.5	1350lm	Ø170*40mm
MG-DB-PNS018/40	18W	4000K	170-240V	0.5	1350lm	Ø170*40mm
MG-DB-PNS018/65	18W	6500K	170-240V	0.5	1350lm	Ø170*40mm
MG-DB-PNS412/30	12W	3000K	170-240V	0.5	720lm	120*120*40mm
MG-DB-PNS412/40	12W	4000K	170-240V	0.5	720lm	120*120*40mm
MG-DB-PNS412/65	12W	6500K	170-240V	0.5	720lm	120*120*40mm
MG-DB-PNS418/30	18W	3000K	170-240V	0.5	1350lm	170*170*40mm
MG-DB-PNS418/40	18W	4000K	170-240V	0.5	1350lm	170*170*40mm
MG-DB-PNS418/65	18W	6500K	170-240V	0.5	1350lm	170*170*40mm

DOWNLIGHT

- ตัวโคมทำจากอะลูมิเนียมขึ้นรูป ประสิทธิภาพการระบายความร้อนดีเยี่ยม
- เลนส์ออปติกระดัดมืออาชีพ 24/38/60°
- ป้องกันแสงสะท้อนเวลาลึกลับ UGR < 19
- ชิป COB ประสิทธิภาพแสงสูง Ra > 90
- ป้องกันแสงสะท้อน สบายตา Anti-Glare
- มาตรฐานความปลอดภัย CB/CE

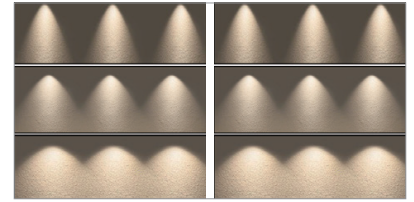

24/38/60° optional



170-240V	CRI ≥90	-20~40°C	IP20	IK02	6500K
----------	---------	----------	------	------	-------

Model	W	PF	lm	Beam Angle	Life	Dimensions (LxWxH)mm
MG-DL-YLD002/10/65	10	0.9	2700/3000	24/38/60°	50000	Ø86*45
MG-DL-YLD002/20/65	20	0.9	3600/4000	24/38/60°	50000	Ø115*55

ขนาด MG-DL-YTDL002/10/65

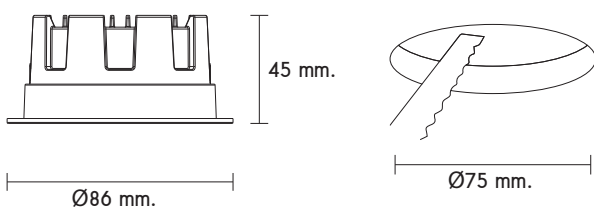

ขนาด MG-DL-YTDL002/20/65

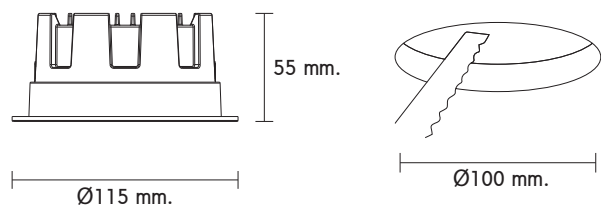

DOWNLIGHT

- รองรับแรงดันไฟฟ้า 170-240V~ 50/60Hz
- ค่าความถูกต้องของสี (CRI) สูงถึง Ra90 แสดงสีได้คมชัดเป็นธรรมชาติ
- อายุการใช้งานยาวนานถึง 30,000 ชั่วโมง
- ระดับการป้องกัน IP20
- Class การป้องกันไฟฟ้า : Class II
- ประสิทธิภาพการส่องสว่าง 90 lm/W
- วัสดุแข็งแรงทนทาน : อลูมิเนียม + PC (แข็งแรง ทนทาน)
- แสงไม่กระพริบ (Flicker Free) ปลอดภัยต่อสายตา



Model	Power	Voltage	PF	Luminous Flux	Beam Angle	Product Size
MG-DB-L002M/10/65	10W	170-240V	0.5	850lm	24°	Ø70*70
MG-DB-L002M/20/65	20W	170-240V	0.5	1800lm	24°	Ø100*90

DOWNLIGHT

- การออกแบบที่เป็นเอกลักษณ์ ตัวโคมวัสดุ PC
- ไตรเวอร์ DOB IC
- มีความแข็งแรงสูง ปลอดภัยและทนทาน
- ป้องกันแสงสะท้อน สบายตา Anti-Glare

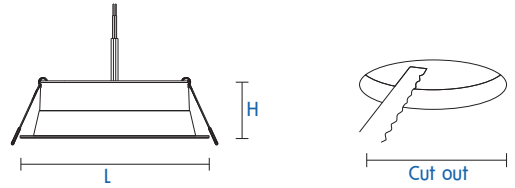

170-240V CRI >=80 -20~40°C IP20 IK02 3000K/4000K/6500K

Model	W	PF	lm	BA	h	Dimensions (LxWxH)mm	Die Cut (LxWxH)mm
MG-DH1131/12/30	12	0.5	960	100°	25000	Ø110*50	Ø100
MG-DH1131/12/40	12	0.5	960	100°	25000	Ø110*50	Ø100
MG-DH1131/12/65	12	0.5	960	100°	25000	Ø110*50	Ø100
MG-DH1131/15/30	15	0.5	1200	100°	25000	Ø140*50	Ø125
MG-DH1131/15/40	15	0.5	1200	100°	25000	Ø140*50	Ø125
MG-DH1131/15/65	15	0.5	1200	100°	25000	Ø140*50	Ø125
MG-DH1131/18/30	18	0.5	1440	100°	25000	Ø165*50	Ø150
MG-DH1131/18/40	18	0.5	1440	100°	25000	Ø165*50	Ø150
MG-DH1131/18/65	18	0.5	1440	100°	25000	Ø165*50	Ø150

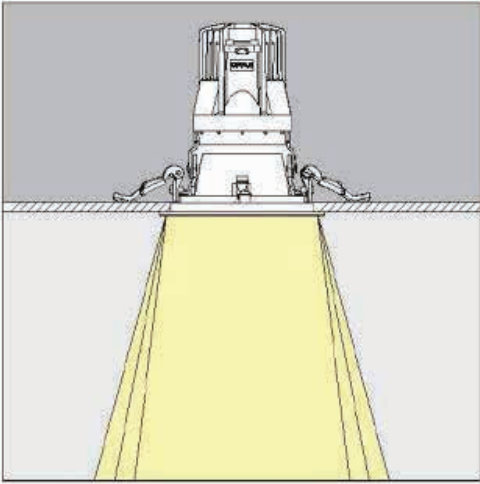

OPL-ROUND-LA/30-24
 OPL-ROUND-LA/30-40
 LED 30W 2500lm (3000K)
 Ø13 x H16.5



OPL-ROUND-LA-30W-WM-24°-3000K

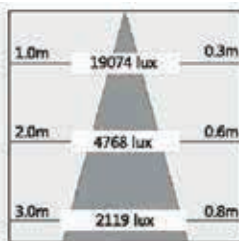
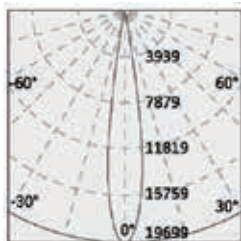

OPL-ROUND-LA-30W-WM-40°-3000K

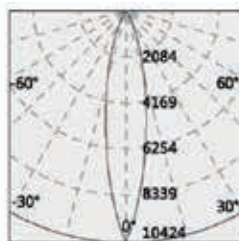

DOWNLIGHT

OPL-DHM14
OPL-DHM29
OPL-DHM42



LED DOWNLIGHT

LIFE : 30000Hrs.

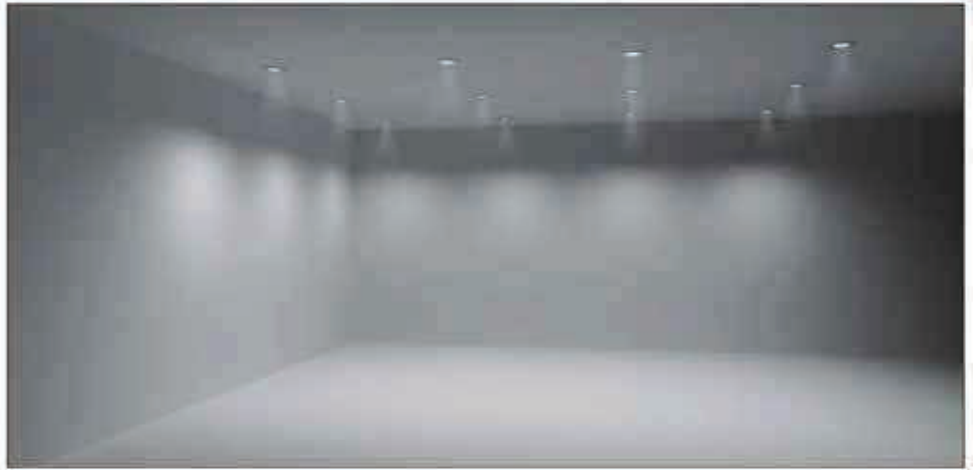
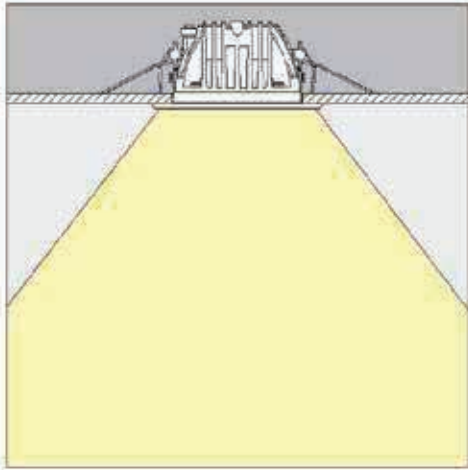

DOWNLIGHT

Recess Downlight

ALUMINIUM BODY, WORKING VOLTAGE AC 85-265V, CHIP TYPE EPISTAR



OPL-DHM14/30
OPL-DHM14/40
OPL-DHM14/57

LED 14W 1200lm (3000K 4000K 5700K)
Ø18.5 x H9.4



17.5

OPL-DHM29/30
OPL-DHM42/30
OPL-DHM29/40
OPL-DHM42/40
OPL-DHM29/57
OPL-DHM42/57

LED 29W, 42W (3000K 4000K 5700K)
Ø22 x H11.6



21

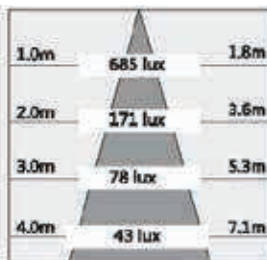
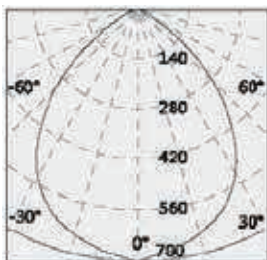

OPL-DHM14/40°-14W-4000K-1200LM

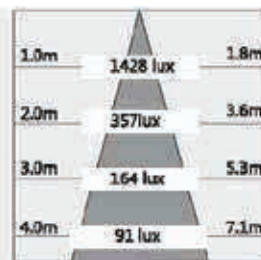
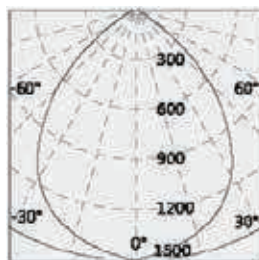

OPL-DHM29/40°-29W-4000K-2500LM



DL-N116-1
W15.5 x L15.5 x H17.5
E27 A60 x 1
700.-



14.3x14.3



DL-N116-2
W15.5 x L29 x H17.5
E27 A60 x 2
1,240.-



13.5 x 26.5

DOWNLIGHT

Recess Downlight

COLD-ROLL STEEL SHEET, COATED WITH POLYESTER POWDER

ALUMINIUM ANODIZED REFLECTOR

RECESSED T-BAR OR GYPSUM MOUNTING



DL-11611
W14 x L14 x H18
E27 A60 x 1
700.-



12x12



DL-11612
W14 x L25 x H18
E27 A60 x 2
1,400.-



12x23

DOWNLIGHT

Recess Downlight

COLD-ROLL STEEL SHEET, COATED WITH POLYESTER POWDER

ALUMINIUM ANODIZED REFLECTOR

RECESSED T-BAR OR GYPSUM MOUNTING



DL-11711
W20 x L20 x H17
E27 A70 x 1
800.-



16.5x16.5



DL-11712
W20 x L36.5 x H17
E27 A70 x 2
1,500.-



16x34

DOWNLIGHT

Recess Downlight

COLD-ROLL STEEL SHEET, COATED WITH POLYESTER POWDER

ALUMINIUM ANODIZED REFLECTOR

RECESSED T-BAR OR GYPSUM MOUNTING



DOWNLIGHT

Recess Downlight

COLD-ROLL STEEL SHEET, COATED WITH POLYESTER POWDER

ALUMINIUM ANODIZED REFLECTOR

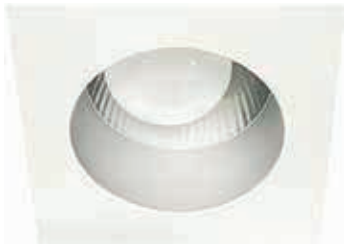

DL-10311
W13 x L13 x H16
E27 x 1
230.-



11x11



DL-10312
W13 x L24 x H16
E27 x 2
400.-



11x22



DL-10313
W13 x L35.5 x H16
E27 x 3
680.-



11x33.5



DOWNLIGHT

Recess Downlight

COLD-ROLL STEEL SHEET, COATED WITH POLYESTER POWDER

ALUMINIUM ANODIZED REFLECTOR

RECESSED T-BAR OR GYPSUM MOUNTING



DL-10661
W13 x L13 x H13.5
E27 x 1
360,-



11.5x11.5



DL-10662
W13 x L24.5 x H13.5
E27 x 2
560,-



11.5x23

DOWNLIGHT

Recess Downlight

COLD-ROLL STEEL SHEET, COATED WITH POLYESTER POWDER

ALUMINIUM ANODIZED REFLECTOR

RECESSED MOUNTING

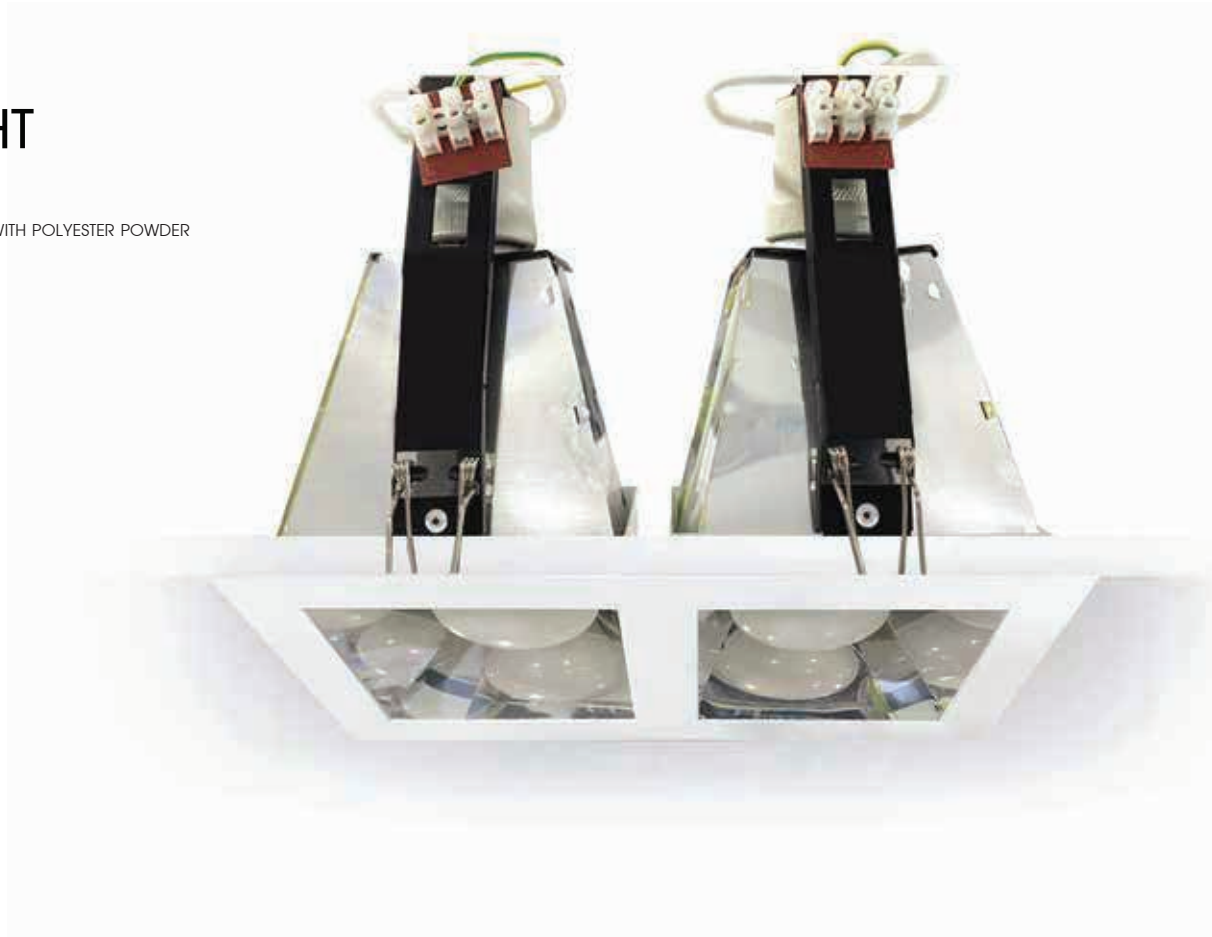

DL-10411
W13 x L13 x H16
E27 x 1
240.-



11x11



DL-10412
W13 x L24.5 x H16
E27 x 2
480.-



11x22.5



DL-10413
W13 x L35.5 x H16
E27 x 3
900.-



11x33

DOWNLIGHT

Recess Downlight

COLD-ROLL STEEL SHEET, COATED WITH POLYESTER POWDER

ALUMINIUM ANODIZED REFLECTOR



DL-P400-1
W18.5 x L18.5 x H14.5
E27 PAR 30 x1
800.-



17x17



DL-P400-2
W18.5 x L33.5 x H14.5
E27 PAR 30 x 2
2,400.-



17x32



หมุนได้ 360°

▶ ขาบริษัท
หน้าคอม

DOWNLIGHT

Recess Downlight

COLD-ROLL STEEL SHEET, COATED WITH POLYESTER POWDER

ALUMINIUM ANODIZED REFLECTOR

RECESSED T-BAR OR GYPSUM MOUNTING



DL-441
W12.8 x L12.8 x H14.5
E27 x 1
180.-



11x11



DL-442
W12.8 x L12.8 x H14.5
E27 x 1
200.-



11x11

DL-441-H16
W12.8 x L12.8 x H16
E27 x 1
180.-



DL-412
W13 x L13 x H16.5
E27 x 1
200.-



11x11



DL-10416
W12.5 x L12.5 x H14.2
E27 x 1
200.-



11x11

หน้าชอบอลูมิเนียม



DOWNLIGHT

Recess Downlight

COLD-ROLL STEEL SHEET, COATED WITH POLYESTER POWDER

ALUMINIUM ANODIZED REFLECTOR

RECESSED T-BAR OR GYPSUM MOUNTING



DL-L1441/S
W13.5 x L13.5 x H13.5
E27 x 1
120.-



11.5x11.5



DL-11416/G
W12.5 x L12.5 x H18
E27 x 1
520.-



11.5x11.5



DL-11811
W12.5 x L12.5 x H18
E27 x 1
720.-



10x10

DOWNLIGHT

Recess Downlight

COLD-ROLL STEEL SHEET, COATED WITH POLYESTER POWDER

ALUMINIUM ANODIZED REFLECTOR

GLASS COVER TO PROVIDE SMOOTH AND DIFFUSE AMBIENT LIGHT

RECESSED MOUNTING



DLN-11416N
W13 x L13 x H7.5
E27 x 1
300.-



11x11



DLN-11418N
W17.5 x L17.5 x H9
E27 x 1
500.-



15.5x15.5



DLN-11418N/2E27
W17.5 x L17.5 x H8.5
E27 x 2
500.-



15.5x15.5





DOWNLIGHT

Recess Downlight

COLD-ROLL STEEL SHEET, COATED WITH POLYESTER POWDER

ALUMINIUM ANODIZED REFLECTOR

GLASS COVER TO PROVIDE SMOOTH AND DIFFUSE AMBIENT LIGHT

RECESSED T-BAR OR GYPSUM MOUNTING



DLN-J165
W16.5 x L16.5 x H13
E27 x 2
550.-



15.5x15.5



DLN-J165/G
W16.5 x L16.5 x H13
E27 x 2
750.-



15.5x15.5

DOWNLIGHT

Recess Downlight

COLD-ROLL STEEL SHEET, COATED WITH POLYESTER POWDER

ALUMINIUM ANODIZED REFLECTOR

GLASS COVER TO PROVIDE SMOOTH AND DIFFUSE AMBIENT LIGHT

RECESSED T-BAR OR GYPSUM MOUNTING

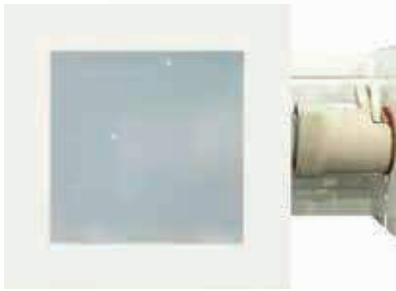
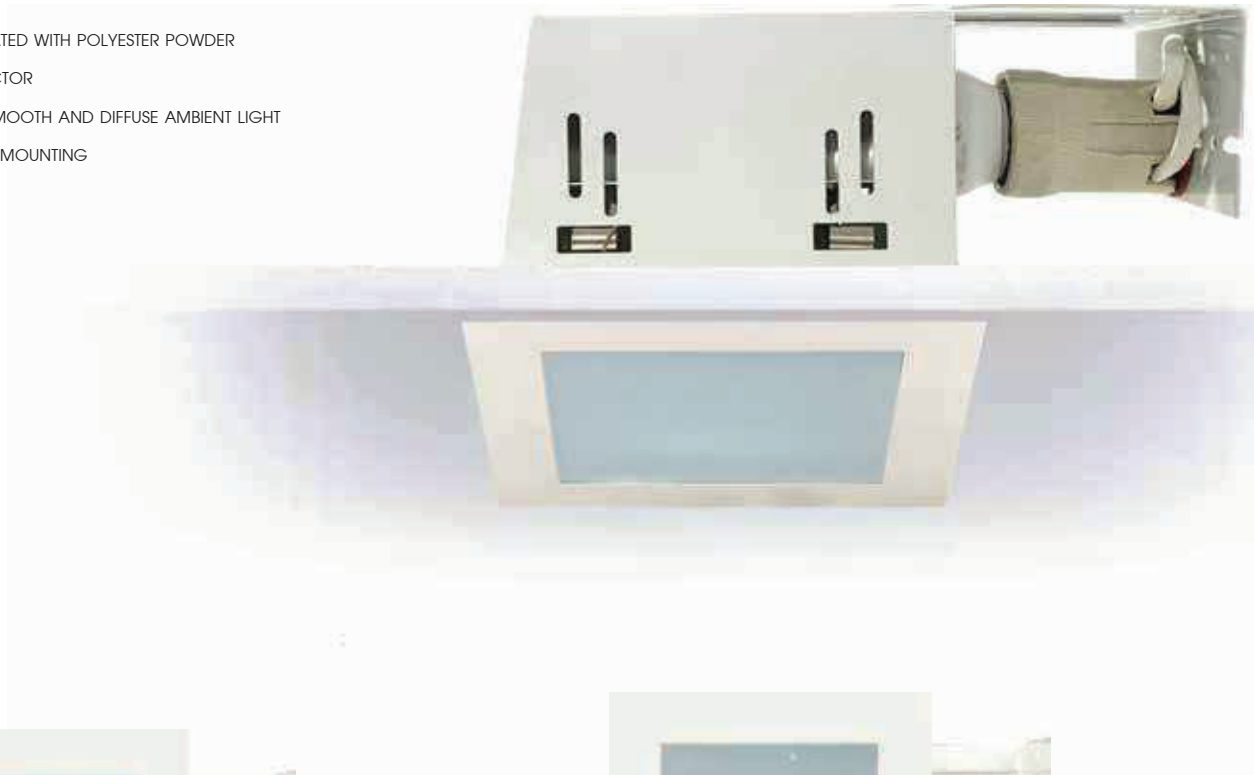

DLN-12610/SYL
W10.5 x L10.5 x H7
E27 x 1
360.-



8.5x8.5



DLN-12612
W13 x L13 x H8.5
E27 x 1
480.-



11.5x11.5

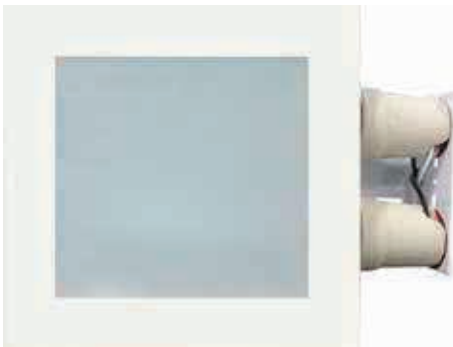

DLN-12614
W16.3 x L16.3 x H8.5
E27 x 2
550.-



14.3x14.3

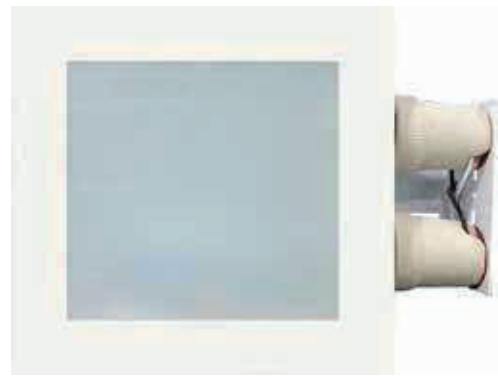

DLN-12616
W18 x L18 x H9
E27 x 2
750.-



16.5x16.5

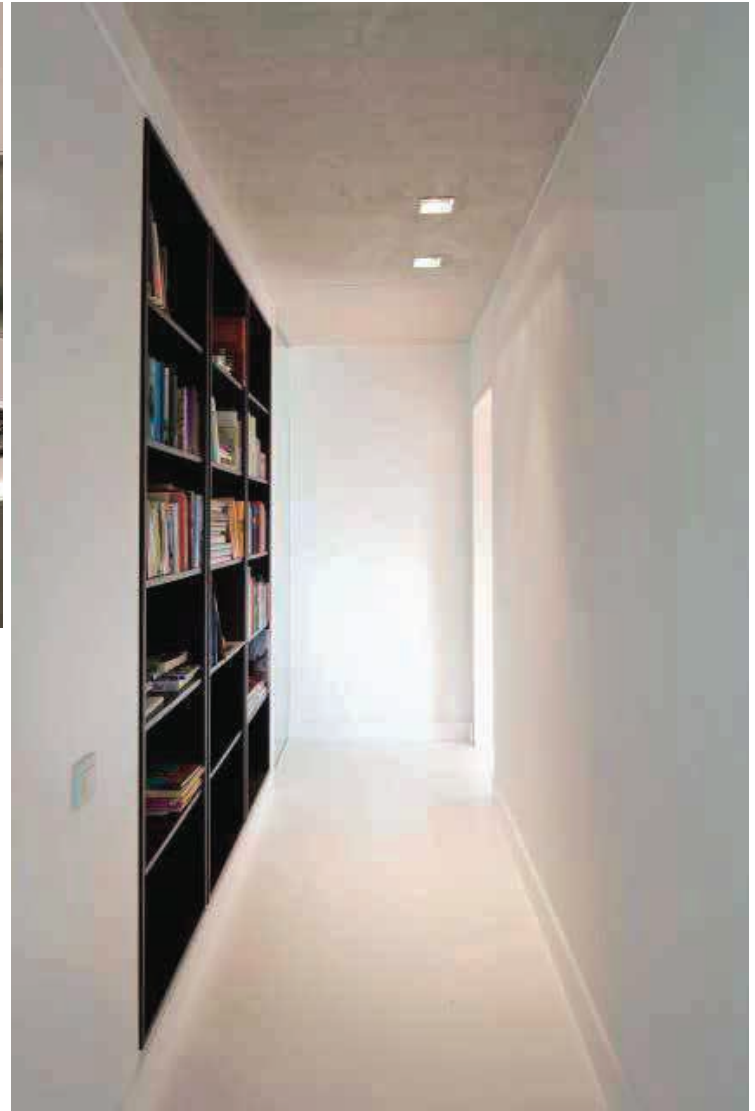

DOWNLIGHT

Recess Downlight

COLD-ROLL STEEL SHEET, COATED WITH POLYESTER POWDER

ALUMINIUM ANODIZED REFLECTOR

GLASS COVER TO PROVIDE SMOOTH AND DIFFUSE AMBIENT LIGHT

RECESSED T-BAR OR GYPSUM MOUNTING



DLN-12611
W12.5 x L12.5 x H8.5
E27 x 1
360.-



11x11

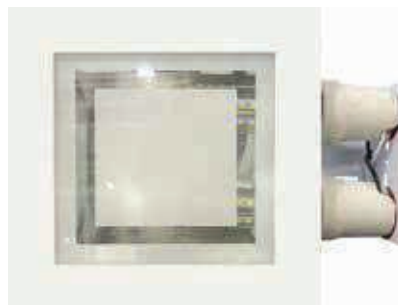

DLN-12613
W16.3 x L16.3 x H8.5
E27 x 2
550.-



14.3x14.3



DLN-12615
W18 x L18 x H9
E27 x 2
750.-



16.5x16.5

DOWNLIGHT

Recess Downlight

COLD-ROLL STEEL SHEET, COATED WITH POLYESTER POWDER

ALUMINIUM ANODIZED REFLECTOR

RECESSED T-BAR OR MOUNTING



DL-10222/WH
Ø13.7 x H16.5
E27 x 1
280.-



11.5



DL-10222/BK
Ø13.7 x H16.5
E27 x 1
300.-



11.5

DOWNLIGHT

Recess Downlight

COLD-ROLL STEEL SHEET, COATED WITH POLYESTER POWDER

ALUMINIUM ANODIZED REFLECTOR

GLASS COVER TO PROVIDE SMOOTH AND DIFFUSE AMBIENT LIGHT



Reflex รุ่นพิเศษ
ช่วยกระจายความร้อน



DL-L141/S
Ø14.5 x H13
E27 x 1
96.-



12.5



DL-L141/SN
Ø14.5 x H13
E27 x 1
96.-



12.5



DL-L171/S
Ø18 x H15.5
E27 A70 x 1
130.-



15.5



DL-L171/SN
Ø18 x H15.5
E27 A70 x 1
130.-



15.5

DOWNLIGHT

Recess Downlight

COLD-ROLL STEEL SHEET, COATED WITH POLYESTER POWDER

ALUMINIUM ANODIZED REFLECTOR

GLASS COVER TO PROVIDE SMOOTH AND DIFFUSE AMBIENT LIGHT



DL-121/3/A
Ø12 x H13.5
E27x1
60.-



DL-171/3/A
Ø18 x H18
E27x1
100.-



DL-171/3/A-1
Ø18 x H18
E27x1
100.-



DL-171/3/SN
Ø18 x H18
E27x1
120.-



DL-171/3/SA
Ø18 x H18
E27x1
120.-



DOWNLIGHT

Recess Downlight

COLD-ROLL STEEL SHEET, COATED WITH POLYESTER POWDER

ALUMINIUM ANODIZED REFLECTOR

GLASS COVER TO PROVIDE SMOOTH AND DIFFUSE AMBIENT LIGHT



DL-P30
Ø14 x H14.5
E27 PAR30 x1
200.-



DL-L141/G-1
Ø14.5 x H13.5
E27 x 1
200.-



DL-L171/G-1
Ø18 x H15.5
E27 A70 x 1
240.-



DOWNLIGHT

Recess Downlight

COLD-ROLL STEEL SHEET, COATED WITH POLYESTER POWDER

ALUMINIUM ANODIZED REFLECTOR



DLN-141/S
Ø14.2 x H8.7
E27 x 1
160.-



12.2



รุ่นพิเศษสูงเพียง 7 cm.

DLN-2600
Ø17.8 x H7
E27x1
320.-



15.8



DLN-171/S
Ø17.8 x H9.5
E27 x 1
220.-



15.8



DLN-171/SN
Ø17.8 x H9.5
E27 x 2
220.-



15.8



DLN-191/A
Ø19 x H8.5
E27 x 1
300.-



17



DLN-191/S
Ø19 x H8.5
E27 x 1
300.-



17



DLN-191/SN
Ø19 x H8.5
E27 x 1
300.-



17

DOWNLIGHT

Recess Downlight

COLD-ROLL STEEL SHEET, COATED WITH POLYESTER POWDER

ALUMINIUM ANODIZED REFLECTOR



DLN-141/G
Ø14.5 x H9
E27 x 1
240.-



12.5



DLN-141/G-1
Ø14.5 x H9
E27 x 1
240.-



12.5



DLN-171/G-1
Ø17.8 x H9.5
E27 x 1
300.-



15.8



DLN-171/G/SYL
Ø17.8 x H11
E27x2
240.-



15.8

DOWNLIGHT

Recess Downlight

COLD-ROLL STEEL SHEET, COATED WITH POLYESTER POWDER

ALUMINIUM ANODIZED REFLECTOR



DLN-2805-A
Ø21.7 x H12.5
E27 x 2/G24x2
600.-



DLN-2701-B
Ø21 x H15
E27x2/G24x2
700.-



DLN-221/S
Ø21.7 x H12.5
E27x2/G24x2
580.-



DLN-221/SN
Ø21.7 x H12.5
E27x2/G24x2
580.-



DLN-221/G
Ø23 x H9
E27x2/G24x2
700.-



DLN-231/G-1
Ø23 x H13
E27x2/G24x2
700.-





DOWNLIGHT

Recess Downlight

COLD-ROLL STEEL SHEET, COATED WITH POLYESTER POWDER

ALUMINIUM ANODIZED REFLECTOR

RECESSED T-BAR OR MOUNTING



DH-3022
Ø17 x H9.3
QR111x1
1,300.-



16.5

DOWNLIGHT

Multiple Recess Downlight

ALUMINIUM, COATED WITH POLYESTER POWDER

RECESSED T-BAR OR GYPSUM MOUNTING



DL-23301/G12

W19 x L19 x H16.5

G12x1

950.-



16.5x16.5



DL-23302/G12

W19 x L35 x H16

G12x2

1,800.-



16.5x33



DL-23111/P30

W20 x L20 x H16

E27x1/PAR30

950.-



17x17



DL-23112/P30

W20 x L35 x H16

E27x2/PAR30

1,800.-



17x32



DL-22111
W19 x L19 x H12.7
QR111x1
500.-



16.5x16.5



DL-22112
W19xL35.2xH12.7
QR111x2
1,000.-



16.50x32

DOWNLIGHT

Multiple Recess Downlight

COLD-ROLL STEEL SHEET, COATED WITH POLYESTER POWDER

ALUMINIUM ANODIZED REFLECTOR

DOWNLIGHT

Multiple Recess Downlight

ALUMINIUM, COATED WITH POLYESTER POWDER

RECESSED T-BAR OR GYPSUM MOUNTING



DH-551
W19 x L19 x H13
QR111x1
920.-



16x16



DH-552/SYL
W21 x L35 x H11
QR111x2
800.-



19x33



DH-553/SYL
W21 x L50 x H11
QR111x3
1,200.-



19x48



DH-20111
W13 x L13 x H11.5
MR16x1
550.-



11x11



DH-20112
W13 x L23.5 x H11.5
MR16x2
1,100.-



11x21.5

DOWNLIGHT

Multiple Recess Downlight

COLD-ROLL STEEL SHEET, COATED WITH POLYESTER POWDER



DH-20121
W13 x L13 x H14.3
MR16x1
600.-



11x11



DH-20122
W13 x L23 x H14.3
MR16x2
1,200.-



11x21.5

DOWNLIGHT

Multiple Recess Downlight

COLD-ROLL STEEL SHEET, COATED WITH POLYESTER POWDER



สามารถดึงหน้าโคมและปรับองศาได้



DH-21816
W12.5 x L12.5 x H12
MR16x1
560.-



10.5x10.5



DH-22816
W12.5 x L23.5 x H12
MR16x2
900.-



11x21.5

DOWNLIGHT

Multiple Recess Downlight

COLD-ROLL STEEL SHEET, COATED WITH POLYESTER POWDER

DOWNLIGHT

Recess Downlight

COLD-ROLL STEEL SHEET, COATED WITH POLYESTER POWDER

RECESSED T-BAR OR GYPSUM MOUNTING



DH-20010
W9 x L9 x H9
MR16x1
250.-



7.5x7.5



DH-20010-G
W9 x L9 x H5.5
MR16x1
350.-



7.5x7.5



DH-20009
W9 x L12 x H7
MR16x1
300.-



7.5x10.5



DH-20010/3
W8.5 x L23 x H5.5
MR16x3
800.-



8x21

DOWNLIGHT

Multiple Recess Downlight

COLD-ROLL STEEL SHEET, COATED WITH POLYESTER POWDER



DH-531
W10 x L10 x H5.5
MR16x1
220,-



DH-532
W10 x L17.5 x H5.5
MR16x2
420,-



DH-533
W10.5 x L24.5 x H5.5
MR16x3
680,-



DH-534
W17.5 x L17.5 x H5.5
MR16x4
960,-





DH-GR17-1
W11 x L11 x H4.5
GU10 x 1
480.-



10x10



DH-GR17-2
W11 x L20.5 x H4.5
GU10 x 2
840.-



10x19.5

DOWNLIGHT

Recess Downlight

COLD-ROLL STEEL SHEET, COATED WITH POLYESTER POWDER

ALUMINIUM ANODIZED REFLECTOR



Hood ក្រណាត់ស្រទាប់



DH-851
W10 x L10 x H9.2
GU10x1
400.-



9x9



DH-852
W10 x L19 x H9.2
GU10x2
800.-



9x18

DOWNLIGHT

Recess Downlight

COLD-ROLL STEEL SHEET, COATED WITH POLYESTER POWDER
ALUMINIUM TRIM



DOWNLIGHT

Recess Downlight

ALUMINIUM, COATED WITH POLYESTER POWDER

RECESSED T-BAR OR GYPSUM MOUNTING



DH-521

W12.5 x L12.5 x H12

MR16x1

350.-



10.5x10.5



DH-522

W12.5 x L23 x H12

MR16x2

580.-



10.5x21



DOWNLIGHT

Recess Downlight

ALUMINIUM, COATED WITH POLYESTER POWDER

RECESSED T-BAR OR GYPSUM MOUNTING



DH-101
W10 x L10 x L5.6
MR16x1
220.-



8.5x8.5



DH-102N
Ø10 x H6
MR16x1
160.-



8.5



DH-2002
W9.2 x L9.2 x H5.5
MR16x1
300.-



7.5x7.5



DH-2002-R
Ø8.7 x H2.2
MR16x1
320.-



7.5

DOWNLIGHT

Multiple Recess Downlight

PURE-ALUMINIUM

RECESSED T-BAR OR GYPSUM MOUNTING



DH-20001
W9 x L9 x H2.5
MR16x1
250.-



8x8



DH-20002
W9 x L17.5 x H2.5
MR16x2
600.-



7.5x15.5



DH-20003
W9 x L25.5 x H2.5
MR16x3
900.-



8x24

DOWNLIGHT

Recess Downlight

COLD-ROLL STEEL SHEET, COATED WITH POLYESTER POWDER

RECESSED MOUNTING



DH-20783
Ø8.7 x H10
MR16x1
350.-



7



DH-20783/G
Ø8.7 x H10
MR16x1
450.-



7



DH-20784
Ø8.7 x H10
MR16x1
350.-



7

DOWNLIGHT

Recessed Downlight

ALUMINIUM COATED WITH POLYESTER POWDER

RECESS MOUNTING



DH-21515
Ø10.5 x H10
MR16x1
480.-



DH-21516
Ø10.5 x H10
MR16x1
480.-



รุ่นนี้ Reflex ตัด



DH-514W
Ø8 x H3
MR16x1
120.-



DH-504W
Ø 9.3 x H4.5
MR16x1
160.-



DOWNLIGHT

Recessed Downlight

ALUMINIUM COATED WITH POLYESTER POWDER



DH-568
Ø10.3 x H2.7
MR16x1
300.-



8.3



DH-569
W10.3 x L10.3 x H2.5
MR16x1
340.-



9x9



DH-20222
Ø 9.3 x H4.5
MR16x1
300.-



8.5



DH-12475
W9 x L9 x H4.5
GU5.3/GU10
300.-



8.5



DOWNLIGHT

Recess Downlight

COLD-ROLL STEEL SHEET, COATED WITH POLYESTER POWDER

ALUMINIUM ANODIZED REFLECTOR

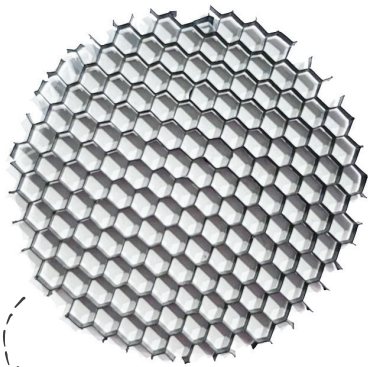

HONEYCOMB MR16 ลดแสงแยงตา
สำหรับใส่กับโคมเฉพาะรุ่นที่ใส่อุปกรณ์เสริมได้



DH-20223
Ø9 x H4
MR16x1
300.-



8



DOWNLIGHT

Recess Downlight

DIE-CAST ALUMINIUM

RECESSED T-BAR OR GYPSUM MOUNTING



D-WW-Q603
Ø15.7 x H11.5
G8.5x1
800.-



14



D-MH-609
Ø16 x H18.5
G12x1
1,200.-



14



D-MH103
Ø19 x H17
G12
1,500.-



17



DB-L141/WH
Ø13 x H14
E27x1
300.-

DB-L141/BK
Ø13 x H14
E27x1
300.-

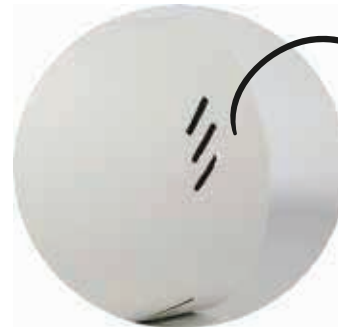

รุ่นใหม่ สิ้นลงและมี
รูระบายอากาศ

DOWNLIGHT

Surface Mounted Downlight

COLD-ROLL STEEL SHEET, COATED WITH POLYESTER POWDER

ALUMINIUM ANODIZED REFLECTOR

SURFACE MOUNTING OR PENDANT



DB-L171/WH
Ø16 x H16
E27x1
400.-

DB-L171/BK
Ø16 x H16
E27x1
400.-



DB-171G/WH
Ø16.5 x H18.5
E27x1
700.-

DB-171G/BK
Ø16.5 x H18.5
E27x1
700.-



DB-421/WH
W11.5 x L11.5 x H16
E27x1
400.-

DB-421/BK
W11.5 x L11.5 x H16
E27x1
400.-



DB-441/WH
W13.8 x L13.8 x H19
E27x1
450.-

DB-441/BK
W13.8 x L13.8 x H19
E27x1
450.-



DB-441/G/WH
W13.8 x L13.8 x H19
E27x1
600.-

DB-441/G/BK
W13.8 x L13.8 x H19
E27x1
600.-



DB-471/WH
W17 x L17 x H22
E27x1
650.-

DB-471/BK
W17 x L17 x H22
E27x1
650.-

DOWNLIGHT

Surface Mounted Downlight

COLD-ROLL STEEL SHEET, COATED WITH POLYESTER POWDER

ALUMINIUM ANODIZED REFLECTOR

SURFACE MOUNTING OR PENDANT



DB-5600-1
Ø9.5 x H12.5
GU10 x 1
1,100.-



DB-5600-2
W17.8 x L9.5 x H12.8
GU10 x 1
2,000.-



DB-5602
W9.5 x L19 x H12.5
GU10 x 2
2,200.-

DOWNLIGHT

Surface Mounted Downlight

COLD-ROLL STEEL SHEET, COATED WITH POLYESTER POWDER

ALUMINIUM ANODIZED REFLECTOR

SURFACE MOUNTING OR PENDANT



DB-31511
W10 x L10 x H16
E27x1
1,200.-



DB-31611
W11 x L11 x H17
E27x1
1,200.-

DOWNLIGHT

Surface Mounted Downlight

COLD ROLL STEEL SHEET, COATED WITH POLYESTER POWDER
SURFACE MOUNTING OR PENDANT



DB-31711
W15 x L15 x H19
E27x1
1,800.-

DOWNLIGHT

Multiple Surface Downlight

COLD ROLL STEEL SHEET, COATED WITH POLYESTER POWDER

SURFACE MOUNTING OR PENDANT



DB-33111
W14 x L14 x H17
QR111x1
1,500.-



DB-33112
W14 x L28 x H17
QR111x2
2,500.-



DB-N116-1
W13.6 x L13.6 x H19
E27x1
1,000.-



DB-N116-2
W13.5 x L27 x H19
E27x2
1,840.-

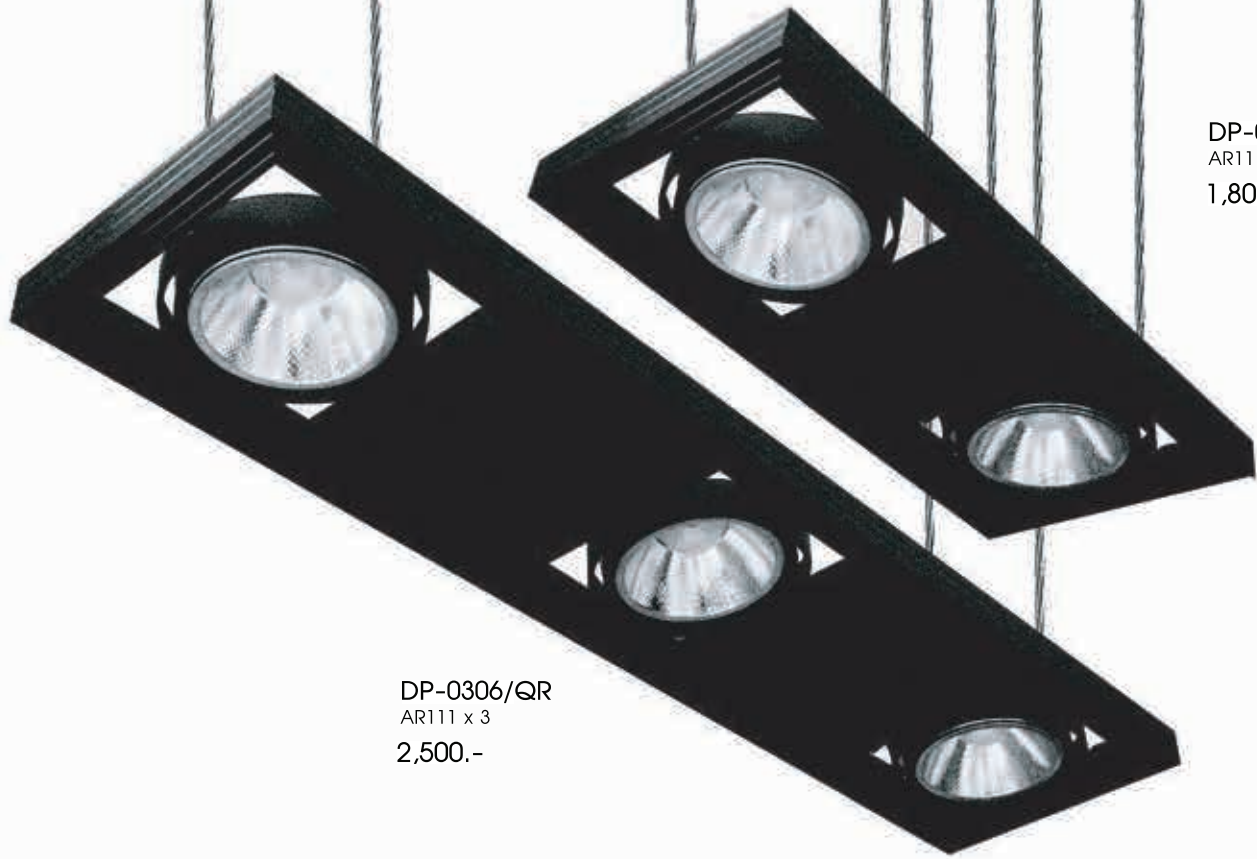

DP-0206/QR
AR111 x 2
1,800.-

DP-0306/QR
AR111 x 3
2,500.-

DOWNLIGHT

Multiple Hanging Downlight

ALUMINIUM, COATED WITH POLYESTER POWDER

SUITABLE FOR SHOP, HOTEL, SHOWROOM, STORE DECORATION

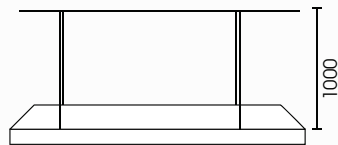
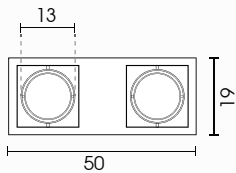

**ສລິງຍາວ 1 ແມັດ

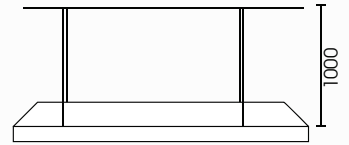
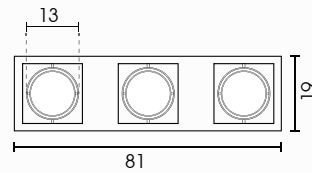

**ສລິງຍາວ 1 ແມັດ



DOWNLIGHT

Surface Mounted Downlight

COLD-ROLL STEEL SHEET, COATED WITH POLYESTER POWDER

ALUMINIUM ANODIZED REFLECTOR

SURFACE MOUNTING OR PENDANT



DB-3902/B/BK

Ø22.5 x H21.7

E27x1

1,800,-



DL-4101

Multiple Recessed Downlight

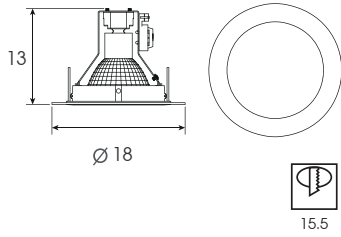

DL-4100

Multiple Recessed Downlight

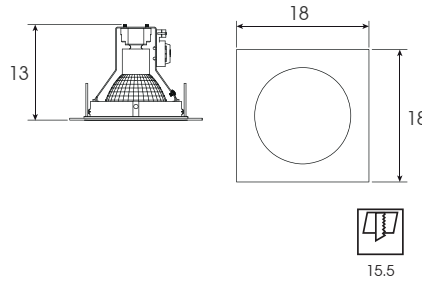

DL-4200

2-Multiple Recessed Downlight

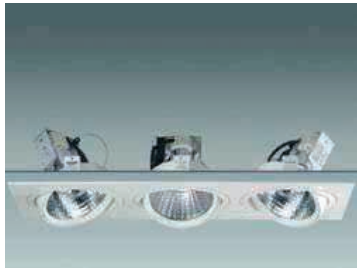
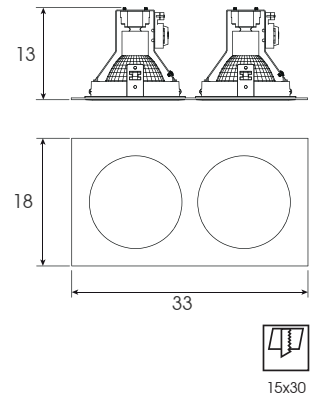

DL-4300



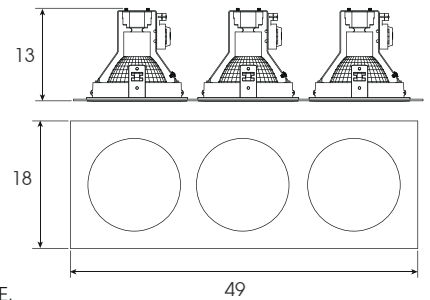



3-Multiple Recessed Downlight



COLD-ROLL STEEL SHEET, COATED WITH POLYESTER POWDER
 RECESSED T-BAR OR GYPSUM MOUNTING
 SUITABLE FOR SHOP, HOTEL, SHOWROOM, STORE DECORATION

MAGIC BOX SERIES

1. THE BOARDS ARE MADE OF QUALITY ALUMINIUM MATERIAL. AND DIFFERENT COLORS ARE AVAILABLE.
2. THE ANGLE OG LIGHT SOURCES IS ADJUSTABLE.
3. THIS SERIES COULD BE WITH DIFFERENT LIGHT SOURCES, SUCH AS QR111, G12, PAR30 AND E27.
4. BALLAST BOX NEEDS TO BE CONNECTED.
5. FRONT RING CAN BE TURNED OUT FOR CHANGING SOURCE.

MODEL NO.	LAMP HOLDER	COMPATIBLE BULB	PRICE
 DL-4100-G12	G12	Compatible Bulb  CDM-T / G12 35W / 70W / 150W	1,000.-
 DL-4100-P30	E27	Compatible Bulb  PAR30 / E27 75W	600.-
 DL-4100-QR111	G53	Compatible Bulb  QR111 / G53 12V 50 / 75 / 100W	350.-

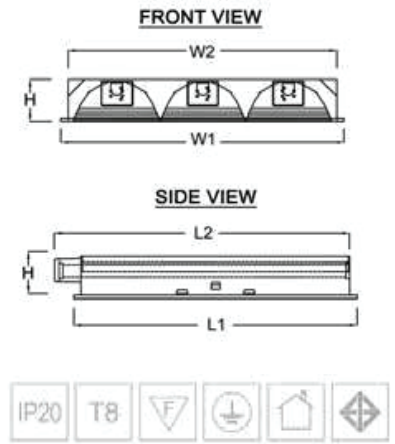

F-LOR

T8 Recessed Louver Luminaire

HOUSING

- MADE OF HIGH QUALITY COLD-ROLLED STEEL SHEET OF THICKNESS 0.6 OR 0.4MM.
- FIVE-STAGE ZINC PHOSPHATE PRETREATMENT FOR RUST RESISTANCE.
- FINISHED WITH WHITE POLYESTER POWDER BY TWO-STAGE ELECTROSTATIC METHOD.
- HEAVY DUTY ROTARY-LOCKED TYPE (G13) LAMP HOLDER (TIS.344-1987 STANDARD)
- ROTARY-LOCKED TYPE STARTER HOLDER (TIS STANDARD)
- CABLE THW (TIS.11-1988 STANDARD)

INSTALLATION & APPLICATION

- FOR RECESSED T-BAR AND GYPSUM CEILING INSTALLATION.
- RECOMMENDED FOR COMMERCIAL BUILDINGS, SHOPS, HOSPITALS, DEPARTMENT STORES, SCHOOLS, ETC



MODEL NO	WATT	DIMENSION (MM.)					CUT OUT (MM.)	REMARK
		L1	L2	W1	W2	H		
F-LOR118	1 X T8 18W	595	620	200	170	80	575 X 185	
F-LOR118/30	1 X T8 18W	595	620	295	265	80	575 X 275	
F-LOR218	2 X T8 18W	595	620	295	265	80	575 X 275	
F-LOR218/60	2 X T8 18W	595	620	595	565	80	575 X 575	
F-LOR318	3 X T8 18W	595	620	595	565	80	575 X 575	
F-LOR418	4 X T8 18W	595	620	595	565	80	575 X 575	
F-LOR136	1 X T8 36W	1195	1222	200	170	80	1175 X 185	
F-LOR136/30	1 X T8 36W	1195	1222	295	265	80	1175 X 275	
F-LOR236	2 X T8 36W	1195	1222	295	265	80	1175 X 275	
F-LOR236/60	2 X T8 36W	1195	1222	595	565	80	1175 X 575	
F-LOR336	3 X T8 36W	1195	1222	595	565	80	1175 X 575	
F-LOR436	4 X T8 36W	1195	1222	595	565	80	1175 X 575	

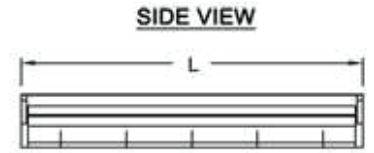
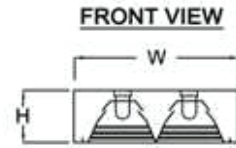

F-LOS

T8 Recessed Louver Luminaire

HOUSING

- MADE OF HIGH QUALITY COLD-ROLLED STEEL SHEET OF THICKNESS 0.6 OR 0.4 MM.
- FIVE-STAGE ZINC PHOSPHATE PRETREATMENT FOR RUST RESISTANCE.
- FINISHED WITH WHITE POLYESTER POWDER BY TWO-STAGE ELECTROSTATIC METHOD.
- HEAVY DUTY ROTARY-LOCKED TYPE (G13) LAMP HOLDER (TIS.344-1987 STANDARD)
- ROTARY-LOCKED TYPE STARTER HOLDER (TIS STANDARD)
- CABLE THW (TIS.11-1988 STANDARD)

INSTALLATION & APPLICATION

- FOR SURFACE CEILING INSTALLATION.
- RECOMMENDED FOR COMMERCIAL BUILDINGS, SHOPS, HOSPITALS, DEPARTMENT STORES, SCHOOLS, ETC



MODEL NO	WATT	DIMENSION (MM.)			REMARK
		L	W	H	
F-LOS118	1 X T8 18W	615	200	80	
F-LOS118/30	1 X T8 18W	615	295	80	
F-LOS218	2 X T8 18W	615	295	80	
F-LOS218/60	2 X T8 18W	615	595	80	
F-LOS318	3 X T8 18W	615	595	80	
F-LOS418	4 X T8 18W	615	595	80	
F-LOS136	1 X T8 36W	1222	200	80	
F-LOS136/30	1 X T8 36W	1222	295	80	
F-LOS236	2 X T8 36W	1222	295	80	
F-LOS236/60/T8	2 X T8 36W	1222	595	80	
F-LOS236/60	2 X T8 36W	1222	595	80	
F-LOS336	3 X T8 36W	1222	595	80	
F-LOS436	4 X T8 36W	1222	595	80	

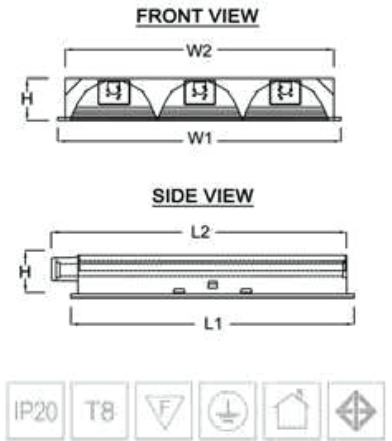

F-LOR/TP

T8 Recessed Louver Luminaire

HOUSING

- MADE OF HIGH QUALITY COLD-ROLLED STEEL SHEET OF THICKNESS 0.6 OR 0.4MM.
- FIVE-STAGE ZINC PHOSPHATE PRETREATMENT FOR RUST RESISTANCE.
- FINISHED WITH WHITE POLYESTER POWDER BY TWO-STAGE ELECTROSTATIC METHOD.
- HEAVY DUTY ROTARY-LOCKED TYPE (G13) LAMP HOLDER (TIS.344-1987 STANDARD)
- ROTARY-LOCKED TYPE STARTER HOLDER (TIS STANDARD)
- CABLE THW (TIS.11-1988 STANDARD)

INSTALLATION & APPLICATION

- FOR RECESSED T-BAR AND GYPSUM CEILING INSTALLATION.
- RECOMMENDED FOR COMMERCIAL BUILDINGS, SHOPS, HOSPITALS, DEPARTMENT STORES, SCHOOLS, ETC



MODEL NO	WATT	DIMENSION (MM.)					CUT OUT (MM.)	REMARK
		L1	L2	W1	W2	H		
F-LOR118/TP	1 X T8 18W	595	620	200	170	80	575 X 185	
F-LOR118/30/TP	1 X T8 18W	595	620	295	265	80	575 X 275	
F-LOR218/TP	2 X T8 18W	595	620	295	265	80	575 X 275	
F-LOR218/60/TP	2 X T8 18W	595	620	595	565	80	575 X 575	
F-LOR318/TP	3 X T8 18W	595	620	595	565	80	575 X 575	
F-LOR418/TP	4 X T8 18W	595	620	595	565	80	575 X 575	
F-LOR136/TP	1 X T8 36W	1195	1222	200	170	80	1175 X 185	
F-LOR136/30/TP	1 X T8 36W	1195	1222	295	265	80	1175 X 275	
F-LOR236/TP	2 X T8 36W	1195	1222	295	265	80	1175 X 275	
F-LOR236/60/TP	2 X T8 36W	1195	1222	595	565	80	1175 X 575	
F-LOR336/TP	3 X T8 36W	1195	1222	595	565	80	1175 X 575	
F-LOR436/TP	4 X T8 36W	1195	1222	595	565	80	1175 X 575	

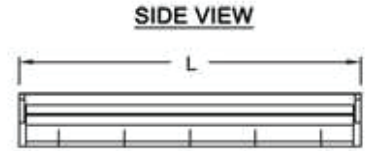
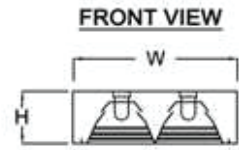

F-LOS/TP

T8 Recessed Louver Luminaire

HOUSING

- MADE OF HIGH QUALITY COLD-ROLLED STEEL SHEET OF THICKNESS 0.6 OR 0.4 MM.
- FIVE-STAGE ZINC PHOSPHATE PRETREATMENT FOR RUST RESISTANCE.
- FINISHED WITH WHITE POLYESTER POWDER BY TWO-STAGE ELECTROSTATIC METHOD.
- HEAVY DUTY ROTARY-LOCKED TYPE (G13) LAMP HOLDER (TIS.344-1987 STANDARD)
- ROTARY-LOCKED TYPE STARTER HOLDER (TIS STANDARD)
- CABLE THW (TIS.11-1988 STANDARD)

INSTALLATION & APPLICATION

- FOR SURFACE CEILING INSTALLATION.
- RECOMMENDED FOR COMMERCIAL BUILDINGS, SHOPS, HOSPITALS, DEPARTMENT STORES, SCHOOLS, ETC



MODEL NO	WATT	DIMENSION (MM.)			REMARK
		L	W	H	
F-LOS118/TP	1 X T8 18W	615	200	80	
F-LOS118/30/TP	1 X T8 18W	615	295	80	
F-LOS218/TP	2 X T8 18W	615	295	80	
F-LOS218/60/TP	2 X T8 18W	615	595	80	
F-LOS318/TP	3 X T8 18W	615	595	80	
F-LOS418/TP	4 X T8 18W	615	595	80	
F-LOS136/TP	1 X T8 36W	1222	200	80	
F-LOS136/30/TP	1 X T8 36W	1222	295	80	
F-LOS236/TP	2 X T8 36W	1222	295	80	
F-LOS236/60/TP	2 X T8 36W	1222	595	80	
F-LOS336/TP	3 X T8 36W	1222	595	80	
F-LOS436/TP	4 X T8 36W	1222	595	80	

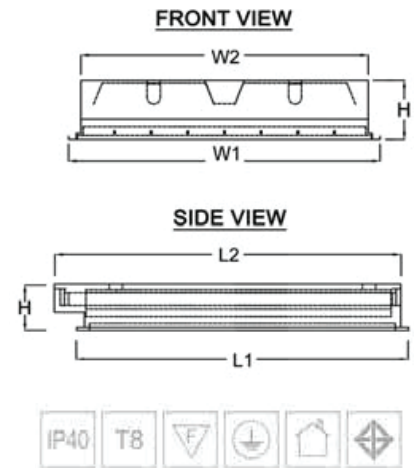

F-LORP

T8 Recessed Louver Luminaire

HOUSING

- MADE OF HIGH QUALITY COLD-ROLLED STEEL SHEET OF THICKNESS 0.6 OR 0.4 MM.
- FIVE-STAGE ZINC PHOSPHATE PRETREATMENT FOR RUST RESISTANCE.
- FINISHED WITH WHITE POLYESTER POWDER BY TWO-STAGE ELECTROSTATIC METHOD.
- HEAVY DUTY ROTARY-LOCKED TYPE (G13) LAMP HOLDER (TIS.344-1987 STANDARD)
- ROTARY-LOCKED TYPE STARTER HOLDER (TIS STANDARD)
- CABLE THW (TIS.11-1988 STANDARD)

INSTALLATION & APPLICATION

- FOR RECESSED T-BAR AND GYPSUM CEILING INSTALLATION.
- RECOMMENDED FOR COMMERCIAL BUILDINGS, SHOPS, HOSPITALS, DEPARTMENT STORES, SCHOOLS, ETC



PRISMATIC
(PR)



OPAL
(OP)



CLEAR
(CL)



STIPPLE
(ST)

MODEL NO	WATT	DIMENSION (MM.)					CUT OUT (MM.)	REMARK
		L1	L2	W1	W2	H		
F-LORP118	1 X T8 18W	595	620	200	170	100	575 X 185	
F-LORP118/30	1 X T8 18W	595	620	295	265	100	575 X 275	
F-LORP218	2 X T8 18W	595	620	295	265	100	575 X 275	
F-LORP218/60	2 X T8 18W	595	620	595	565	100	575 X 575	
F-LORP318	3 X T8 18W	595	620	595	565	100	575 X 575	
F-LORP418	4 X T8 18W	595	620	595	565	100	575 X 575	
F-LORP136	1 X T8 36W	1195	1222	200	170	100	1175 X 185	
F-LORP136/30	1 X T8 36W	1195	1222	295	265	100	1175 X 275	
F-LORP236	2 X T8 36W	1195	1222	295	265	100	1175 X 275	
F-LORP236/60	2 X T8 36W	1195	1222	595	565	100	1175 X 575	
F-LORP336	3 X T8 36W	1195	1222	595	565	100	1175 X 575	
F-LORP436	4 X T8 36W	1195	1222	595	565	100	1175 X 575	

F-LORP___/B/A

B = ACRYLIC TYPE (PR, OP, ST, CL)

A = REFLECTANCE OF ALUMINIUM REFLECTOR (87=87% , 95=95%)

ถ้าไม่มี คือ ไม่มี REFLECTOR

FLUORESCENT

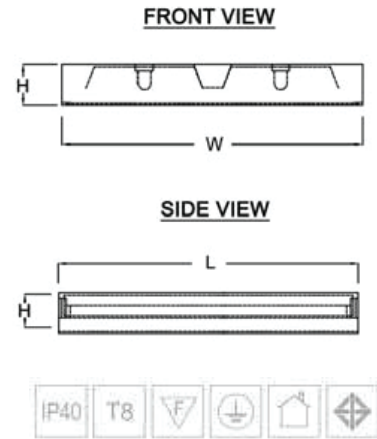

F-LOSP

T8 Surface Mounted Acrylic Diffuser Luminaire

HOUSING

- MADE OF HIGH QUALITY COLD-ROLLED STEEL SHEET OF THICKNESS 0.6 OR 0.4 MM.
- FIVE-STAGE ZINC PHOSPHATE PRETREATMENT FOR RUST RESISTANCE.
- FINISHED WITH WHITE POLYESTER POWDER BY TWO-STAGE ELECTROSTATIC METHOD.
- HEAVY DUTY ROTARY-LOCKED TYPE (G13) LAMP HOLDER (TIS.344-1987 STANDARD)
- ROTARY-LOCKED TYPE STARTER HOLDER (TIS STANDARD)
- CABLE THW (TIS.11-1988 STANDARD)

INSTALLATION & APPLICATION

- FOR SURFACE CEILING INSTALLATION.
- RECOMMENDED FOR COMMERCIAL BUILDINGS, SHOPS, HOSPITALS, DEPARTMENT STORES, SCHOOLS, ETC



MODEL NO	WATT	DIMENSION (MM.)			REMARK
		L	W	H	
F-LOSP118	1 X T8 18W	615	200	82	
F-LOSP118/30	1 X T8 18W	615	295	82	
F-LOSP218	2 X T8 18W	615	295	82	
F-LOSP218/60	2 X T8 18W	615	595	82	
F-LOSP318	3 X T8 18W	615	595	82	
F-LOSP418	4 X T8 18W	615	595	82	
F-LOSP136	1 X T8 36W	1222	200	82	
F-LOSP136/30	1 X T8 36W	1222	295	82	
F-LOSP236	2 X T8 36W	1222	295	82	
F-LOSP236/60	2 X T8 36W	1222	595	82	
F-LOSP336	3 X T8 36W	1222	595	82	
F-LOSP436	4 X T8 36W	1222	595	82	

F-LORP___/B/A

B = ACRYLIC TYPE (PR, OP, ST, CL)

A = REFLECTANCE OF ALUMINIUM REFLECTOR (87=87% , 95=95%)

ถ้าไม่มี คือ ไม่มี REFLECTOR



F-CURVE1

Recessed Mounted Luminaire

HOUSING

- MADE OF HIGHT QUALITY COLD-ROLLED STEEL SHEET OF THICKNESS 0.6 (T6)
- FIVE-STAGE ZINC PHOSPHATE PRETRATMENT FOR RUST RESISTANCE.
- FINISHED WITH WHITE POLYESTER POWDER BY TWO-STAGE ELECTROSTATIC METHOD.
- HEAVY DUTY ROTARY-LOCKED TYPE (G13) LAMP HOLDER (TIS.344-1987 STANDARD).
- ROTARY-LOCKED TYPE STARTER HOLDER (TIS STANDARD).
- SPRING-LOCK TYPE FRAME FOR EASE OF MAINTENANCE.

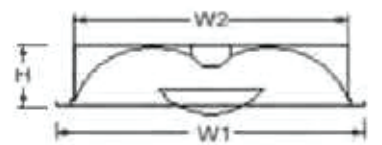

MODEL NO	WATT	DIMENSION (MM.)					CUT OUT (MM.)
		L1	L2	W1	W2	H	
F-CURVE1-218F	2 X T8 18W	620	595	595	565	115	575 X 575
F-CURVE1-236F	2 X T8 36W	1220	1195	595	565	115	1172 X 575



F-CURVE-V

Recessed Mounted Luminaire

HOUSING

- MADE OF HIGHT QUALITY COLD-ROLLED STEEL SHEET OF THICKNESS 0.6 (T6)
- FIVE-STAGE ZINC PHOSPHATE PRETRATMENT FOR RUST RESISTANCE.
- FINISHED WITH WHITE POLYESTER POWDER BY TWO-STAGE ELECTROSTATIC METHOD.
- HEAVY DUTY ROTARY-LOCKED TYPE (G13) LAMP HOLDER (TIS.344-1987 STANDARD).
- ROTARY-LOCKED TYPE STARTER HOLDER (TIS STANDARD).
- SPRING-LOCK TYPE FRAME FOR EASE OF MAINTENANCE.

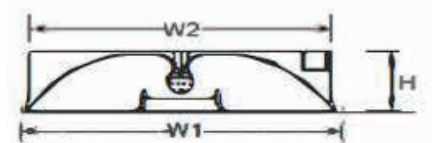

MODEL NO	WATT	DIMENSION (MM.)					CUT OUT (MM.)
		L1	L2	W1	W2	H	
F-CURVE-V-218F	2 X T8 18W	620	595	595	565	100	605 X 580
F-CURVE-V-236F	2 X T8 36W	1220	1195	595	565	100	1205 X 575

F-FRAME

Recessed Mounted with Downlight Luminaire

HOUSING

- MADE OF HIGH QUALITY COLD-ROLLED STEEL SHEET OF THICKNESS 0.6 (T6)
- FIVE-STAGE ZINC PHOSPHATE PRETREATMENT FOR RUST RESISTANCE.
- FINISHED WITH WHITE POLYESTER POWDER BY TWO-STAGE ELECTROSTATIC METHOD.
- HEAVY DUTY ROTARY-LOCKED TYPE (G13) LAMP HOLDER (TIS,344-1987 STANDARD)
- DUAL QR111 DOWNLIGHT ON BOTH END (OPTIONAL : OTHER DOWNLIGHTS ARE AVAILABLE UPON REQUEST)
- 99.85% HIGH PURITY ANODIZED ALUMINIUM REFLECTOR WITH TOTAL REFLECTANCE OF 87% (87)
- OPAL ACRYLIC DIFFUSER FOR SMOOTH LIGHT DISTRIBUTION

MODEL NO	WATT	DIMENSION (MM.)				
		L1	L2	W1	W2	H
F-FRAME136/QR	1 X T8 36W	1646	1622	206	180	140
F-FRAME236/QR	2 X T8 36W	1646	1622	206	180	140

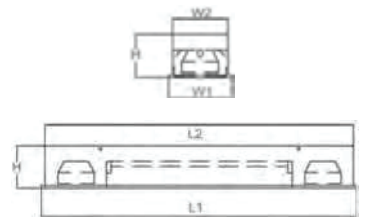

F-HB

T8, Acrylic Diffuser Type Fluorescent High Bay

HOUSING

- Made of high quality cold-rolled steel sheet of thickness 0.6 (T6) or 0.8mm.(T8).
- Five-stage zinc phosphate pretreatment for rust resistance.
- Finished with white polyester powder by two-stage electrostatic method.
- Heavy duty rotary-locked type (GS) lamp holder (TIS.34-1987 Standard)
- Cable THW 1.0 sq.mm. 70°C (TIS.11-1988 Standard). Optional: 10S°C 18AWG UL Standard.

INSTALLATION & APPLICATION

- For surface mounted or suspension rods installation.
- Recommended for warehouses, factories, gymnasium, etc.

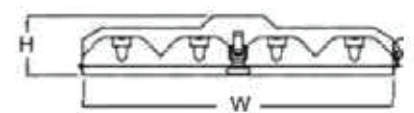

MODEL NO	WATT	DIMENSION (MM.)			REMARK
		L	W	H	
F-HB336/NA/87	3 X T8 36W	1222	525	94	
F-HB436/NA/87	4 X T8 36W	1222	525	94	
F-HB636/NA/87	6 X T8 36W	1222	525	94	
F-HB336/CL/87	3 X T8 36W	1222	525	94	
F-HB436/CL/87	4 X T8 36W	1222	525	94	





F-A

T8 Batten Type Luminaire

HOUSING

- HIGH QUALITY COLD- ROLLED STEEL HOUSING OF THICKNESS 0.4
- FIVE-STAGE ZINC PHOSPHATE PRETREATMENT FOR RUST RESISTANCE.
- FINISHED WITH WHITE POLYESTER POWDER BY TWO-STAGE ELECTROSTATIC METHOD.
- ROTARY-LOCKED TYPE STARTER HOLDER (TIS.344-1987 STANDARD)
- CABLE THW (TIS.11-1988 STANDARD)

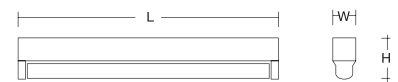

MODEL NO	WATT	DIMENSION (MM.)		
		L	W	H
F-L60	1 X T8 LED	600	33	17
F-L120	1 X T8 LED	1225	35	17
F-A118	1 X T8 18W	636	60	97
F-A218	2 X T8 18W	636	120	97
F-A136	1 X T8 36W	1245	60	97
F-A236	2 X T8 36W	1245	120	97



F-R

T8 Asymmetric Batten Type Luminaire

HOUSING

- HIGH QUALITY COLD-ROLLED STEEL HOUSING OF 0.4MM.
- FIVE-STAGE ZINC PHOSPHATE PRETREATMENT FOR RUST RESISTANCE.
- FINISHED WITH WHITE POLYESTER POWDER BY TWO-STAGE ELECTROSTATIC METHOD.
- ROTARY-LOCKED TYPE STARTER HOLDER (TIS.344-1987 STANDARD)
- HEAVY DUTY LAMP HOLDER (TIS.344-1987 STANDARD)
- CABLE THW (TIS.11-1988 STANDARD)



MODEL NO	WATT	DIMENSION (MM.)		
		L	W	H
F-R118	1 X T8 18W	636	60	133
F-R136	1 X T8 36W	1245	60	133



F-WING

Surface Mounted Luminaire

HOUSING

- MADE OF HIGH QUALITY COLD-ROLLED STEEL SHEET OF THICKNESS 0.6 (T8)
- FIVE-STAGE ZINC PHOSPHATE PRETREATMENT FOR RUST RESISTANCE.
- FINISHED WITH WHITE POLYESTER POWDER BY TWO-STAGE ELECTROSTATIC METHOD.
- HEAVY DUTY ROTARY-LOCKED TYPE (G13) LAMP HOLDER (TIS.344-1987 STANDARD)
- ROTARY-LOCKED TYPE STARTER HOLDER (TIS STANDARD) FOR T8 LAMP

MODEL NO	WATT	DIMENSION (MM.)		
		L	W	H
F-WING218F	2 X T8 18W	630	295	115
F-WING236F	2 X T8 36W	1240	295	115



F-U

T8 U-Type Acrylic Diffuser Luminaire

HOUSING

- INJECTED POLYCARBONATE(PC) IN GREY COLOR WITH INJECTION MOLDED CLEAR PRISMATIC UV STABILIZED POLYCARBONATE (PC) WITH CURVED TO ANTI-GLARE.
- COLD-ROLLED STEEL PLATE, FINISHED WITH HIGH GLOSSY BAKED WHITE POLYESTER POWDER COATING
- STAINLESS CLIP LOCK (SL). OPTINAL: POLYCARBONATE (PC) CLIP LOCK
- ROTARY-LOCKED TYPE LAMP HOLDER G13 (TIS.344-1987 STANDARD)
- ROTARY-LOCKED TYPE STARTER HOLDER (TIS.344-1987 STANDARD)
- CABLE THW (TIS.11-1988 STANDARD).
- SUITABLE FOR SEMI-OUTDOOR OR OUTDOOR APPLICATION



MODEL NO	WATT	DIMENSION (MM.)		
		L	W	H
F-U118	1 X T8 18W.	636	70	80
F-U218	2 X T8 18W.	636	200	80
F-U136	1 X T8 36W.	1245	70	80
F-U236	2 X T8 36W.	1245	200	80



F-FW/F-FAL

T8 Industrial Type Luminaire

HOUSING

- HIGH QUALITY COLD-ROLLED STEEL HOUSING OF THICKNESS 0.4MM.
- FIVE-STAGE ZINC PHOSPHATE PRETREATMENT FOR RUST RESISTANCE.
- FINISHED WITH WHITE POLYESTER POWDER BY TWO-STAGE ELECTROSTATIC METHOD.
- POWDER PAINTED SHEEL SHEET REFLECTOR. OPTIONAL: 99.85% HIGH PURTTY ANODIZED ALUMINIUM REFLECTOR WITH TOTAL REFLECTANCE OF 87%(87) OR 95%(95)
- ROTARY-LOCKED TYPE STARTER HOLDER (TIS.344-1987 STANDARD)
- HEAVY DUTY LAMP HOLDER (TIS.344-1987 STANDARD)
- CABLE THW TIS.11-1988 STANDARD).
- SUITABLE FOR GENERAL PURPOSE WITH HIGH EFFICIENCY REQUIREMENT

MODEL NO	WATT	DIMENSION (MM.)			
		L1	W1	W2	H
F-FW118	1 X T8 18W	636	135	60	101
F-FAL118	1 X T8 18W	636	135	60	101
F-FW218	2 X T8 18W	636	230	120	101
F-FAL218	2 X T8 36W	636	230	120	101
F-FW136	1 X T8 36W	1245	135	60	101
F-FAL136	1 X T8 36W	1245	135	60	101
F-FW236	2 X T8 36W	1245	230	120	101
F-FAL236	2 X T8 36W	1245	230	120	101

F-FAL

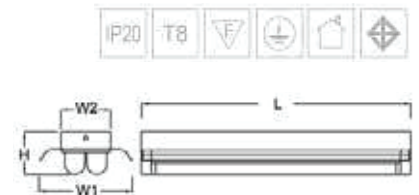

F-V

T8 Taper Batten Type Luminaire

HOUSING

- HIGH QUALITY COLD-ROLLED STEEL HOUSING OF THICKNESS 0.4MM.
- FIVE-STAGE ZINC PHOSPHATE PRETREATMENT FOR RUST RESISTANCE.
- FINISHED WITH WHITE POLYESTER POWDER BY TWO-STAGE ELECTROSTATIC METHOD.
- ROTARY-LOCKED TYPE STARTER HOLDER (TIS.344-1987 STANDARD)
- HEAVY DUTY LAMP HOLDER (TIS.344-1987 STANDARD)
- CABLE THW (TIS.11-1988 STANDARD).
- SUITABLE FOR GENERAL PURPOSE WITH HIGH EFFICIENCY REQUIREMENT

MODEL NO	WATT	DIMENSION (MM.)		
		L	W	H
F-V118	1 X T8 18W	636	155	115
F-V218	2 X T8 18W	636	155	90
F-V136	1 X T8 36W	1245	155	115
F-V236	2 X T8 36W	1245	155	90

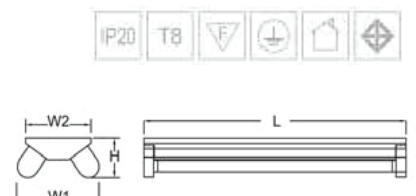



F-WP-E218

T8 Weather Proof Luminaire

HOUSING

- INJECTED POLYCARBONATE(PC) IN GREY COLOR WITH INJECTION MOLDED CLEAR PRISMATIC UV STABILIZED POLYCARBONATE (PC) WITH CURVED TO ANTI-GLARE.
- COLD-ROLLED STEEL PLATE, FINISHED WITH HIGH GLOSSY BAKED WHITE POLYESTER POWDER COATING
- STAINLESS CLIP LOCK (SL). OPTINAL: POLYCARBONATE (PC) CLIP LOCK
- ROTARY-LOCKED TYPE LAMP HOLDER G13 (TIS.344-1987 STANDARD)
- CABLE THW (TIS.11-1988 STANDARD).
- SUITABLE FOR SEMI-OUTDOOR OR OUTDOOR APPLICATION

MODEL NO	WATT	DIMENSION (MM.)		
		L	W	H
F-WP-E218	2 X T8 LED	1267	110	60

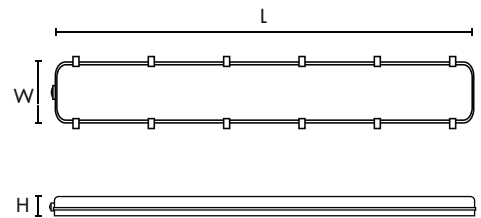

คุณสมบัติ

- ระบายความร้อนได้ดี
- ระดับการกระเทก IK08
- ระดับกันน้ำ กันฝุ่น IP65
- ฝาครอบพลาสติกอย่างดี ป้องกัน UV

ประโยชน์ที่ได้รับ

- เนื่องจากมีระดับการกันน้ำ กันฝุ่น ถึง IP65
- จึงเหมาะกับการใช้งานภายนอก
- ทนแรงกระเทกได้
- ฝาครอบป้องกันการเปลี่ยนสี

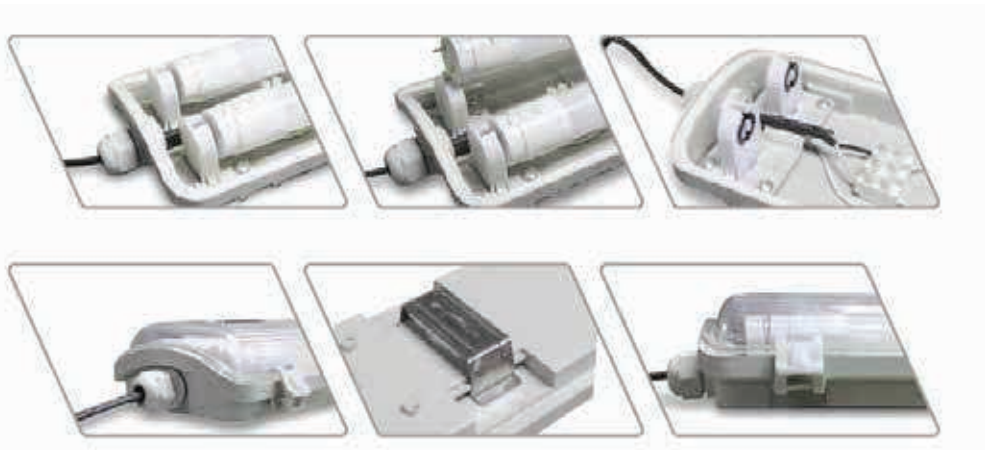

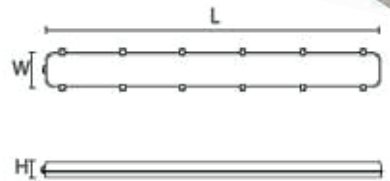

F-WP-E

T8 Weather Proof Luminaire

HOUSING

- INJECTED POLYCARBONATE(PC) IN GREY COLOR WITH INJECTION MOLDED CLEAR PRISMATIC UV STABILIZED POLYCARBONATE (PC) WITH CURVED TO ANTI-GLARE.
- COLD-ROLLED STEEL PLATE, FINISHED WITH HIGH GLOSSY BAKED WHITE POLYESTER POWDER COATING
- STAINLESS CLIP LOCK (SL). OPTINAL: POLYCARBONATE (PC) CLIP LOCK
- ROTARY-LOCKED TYPE LAMP HOLDER G13 (TIS.344-1987 STANDARD)
- CABLE THW (TIS.11-1988 STANDARD).
- SUITABLE FOR SEMI-OUTDOOR OR OUTDOOR APPLICATION

OPTIONAL: ANODIZED ALUMINIUM REFLECTOR TR 87% MIRROR FINISHED

MODEL NO	WATT	DIMENSION (MM.)		
		L	W	H
F-WP-E109	1 X T8 LED	670	85	60
F-WP-E118	1 X T8 LED	1280	85	60



F-COMPACT1

T8 U-Shape Acrylic Guard Batten Type Luminaire

HOUSING

- FIVE-STAGE ZINC PHOSPHATE PRETREATMENT FOR RUST RESISTANCE.
- FINISHED WITH WHITE POLYESTER POWDER BY TWO-STAGE ELECTROSTATIC METHOD.
- HIGH QUALITY ACRYLIC DIFFUSER WITH STEEL PAINTED FRAME.
- HEAVY DUTY ROTARY LOCKED TYPE LAMP HOLDER (TIS.344-1987 STANDARD)
- CABLE THW (TIS.11-1988 STANDARD).
- SUITABLE FOR GENERAL PURPOSE WITH HIGH EFFICIENCY REQUIREMENT

MODEL NO	WATT	DIMENSION (MM.)		
		L	W	H
F-COMPACT1-118-P	1 X T8 18W	645	47	70
F-COMPACT2-118-P	1 X T8 18W	645	47	70
F-COMPACT1-136-P	1 X T8 36W	1250	47	70

โคมเปล้าสำหรับใส่หลอด LED



F-COMPACT

T8 U-Shape Acrylic Guard Batten Type Luminaire

HOUSING

- FIVE-STAGE ZINC PHOSPHATE PRETREATMENT FOR RUST RESISTANCE.
- FINISHED WITH WHITE POLYESTER POWDER BY TWO-STAGE ELECTROSTATIC METHOD.
- HIGH QUALITY ACRYLIC DIFFUSER WITH STEEL PAINTED FRAME.
- HEAVY DUTY ROTARY LOCKED TYPE LAMP HOLDER (TIS.344-1987 STANDARD)
- CABLE THW (TIS.11-1988 STANDARD).
- SUITABLE FOR GENERAL PURPOSE WITH HIGH EFFICIENCY REQUIREMENT

MODEL NO	WATT	DIMENSION (MM.)		
		L	W	H
F-COMPACT118	1 X T8 18W	636	45	90
F-COMPACT118-P	1 X T8 18W	636	45	90
F-COMPACT136	1 X T8 36W	1240	45	90
F-COMPACT136-P	1 X T8 36W	1240	45	90

โคมเปล้าสำหรับใส่หลอด LED





F-WG/S

T8 Wire-Guard Luminaire

HOUSING

- HIGH QUALITY COLD- ROLLED STEEL HOUSING OF THICKNESS 0.6
- FIVE-STAGE ZINC PHOSPHATE PRETREATMENT FOR RUST RESISTANCE.
- FINISHED WITH WHITE POLYESTER POWDER BY TWO-STAGE ELECTROSTATIC METHOD.
- ROTARY-LOCKED TYPE STARTER HOLDER (TIS.344-1987 STANDARD)
- CABLE THW (TIS.11-1988 STANDARD)

MODEL NO	WATT	DIMENSION (MM.)		
		L	W	H
F-WG118/S	1 X T8 18W	625	60	100
F-WG136/S	1 X T8 36W	1250	60	100
F-WG236/S	2 X T8 36W	1250	120	100

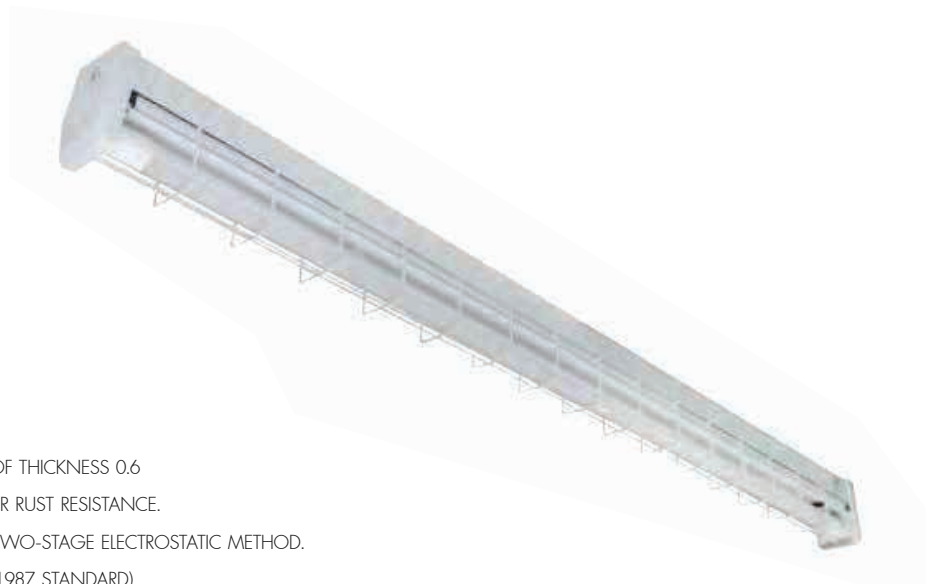
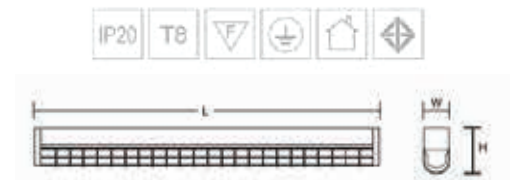

F-WGS

T8 Wire-Guard Luminaire

HOUSING

- HIGH QUALITY COLD- ROLLED STEEL HOUSING OF THICKNESS 0.6
- FIVE-STAGE ZINC PHOSPHATE PRETREATMENT FOR RUST RESISTANCE.
- FINISHED WITH WHITE POLYESTER POWDER BY TWO-STAGE ELECTROSTATIC METHOD.
- ROTARY-LOCKED TYPE STARTER HOLDER (TIS.344-1987 STANDARD)
- CABLE THW (TIS.11-1988 STANDARD)

кавалит 3 мм.

MODEL NO	WATT	DIMENSION (MM.)		
		L	W	H
F-WGS136	1 X T8 36W	1230	58	98
F-WGS118	1 X T8 18W	630	58	98



F-HL-N220/P/BK

Pendant Aluminium Luminaire



F-HL-N120/P/BK

Pendant Aluminium Luminaire

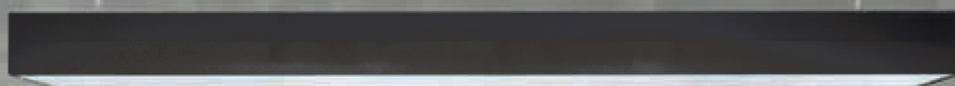

FLUORESCENT LAMP

HOUSING

- MADE OF HIGH QUALITY COLD-ROLLED STEEL SHEET OF THICKNESS 0.6 (T6)
- FINISHED WITH WHITE POLYESTER POWDER BY TWO-STAGE ELECTROSTATIC METHOD.
- HEAVY DUTY ROTARY-LOCKED TYPE (TIS.344-1987 STANDARD)
- OPAL ACRYLIC DIFFUSER FOR SMOOTH LIGHT DISTRIBUTION

MODEL NO	WATT	DIMENSION (MM.)		
		L	W	H
F-HL-N120/P/BK	1 X T8 LED.	1250	70	80
F-HL-N220/P/BK	2 X T8 LED	1250	170	80

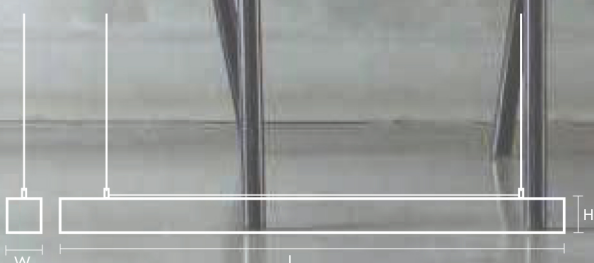

FLUORESCENT



F-HL-SLIM/P

Pendant Acrylic Luminaire

HOUSING

- MADE OF HIGH QUALITY COLD-ROLLED STEEL SHEET OF THICKNESS 0.6 (T6)
- FIVE-STAGE ZINC PHOSPHATE PRETREATMENT FOR RUST RESISTANCE.
- FINISHED WITH WHITE POLYESTER POWDER BY TWO-STAGE ELECTROSTATIC METHOD.
- HEAVY DUTY ROTARY-LOCKED TYPE (TIS.344-1987 STANDARD)
- OPAL ACRYLIC DIFFUSER FOR SMOOTH LIGHT DISTRIBUTION



MODEL NO	WATT	DIMENSION (MM.)		
		L	W	H
F-HL-SLIM120/P	1 X T8 18W	1245	100	100
F-HL-SLIM220/P	2 X T8 36W	1245	150	100



F-RS-SLIM/P

T8 Recessed Acrylic Diffuser Luminaire

HOUSING

- MADE OF HIGH QUALITY COLD-ROLLED STEEL SHEET OF THICKNESS 0.6 (T6)
- FIVE-STAGE ZINC PHOSPHATE PRETREATMENT FOR RUST RESISTANCE.
- FINISHED WITH WHITE POLYESTER POWDER BY TWO-STAGE ELECTROSTATIC METHOD.
- HEAVY DUTY ROTARY-LOCKED TYPE (TIS.344-1987 STANDARD)
- OPAL ACRYLIC DIFFUSER FOR SMOOTH LIGHT DISTRIBUTION



MODEL NO	WATT	DIMENSION (MM.)				
		L1	L2	W1	W2	H
F-RS-SLIM120/P	1 X T8 LED	1265	1245	100	85	100
F-RS-SLIM220/P	2 X T8 LED	1265	1245	150	130	100

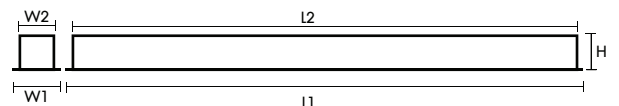



F-HL-SLIM/L

Pendant Louver Luminaire

HOUSING

- MADE OF HIGH QUALITY COLD-ROLLED STEEL SHEET OF THICKNESS 0.6 (T6)
- FIVE-STAGE ZINC PHOSPHATE PRETREATMENT FOR RUST RESISTANCE.
- FINISHED WITH POLYESTER POWDER BY TWO-STAGE ELECTROSTATIC METHOD.
- HEAVY DUTY ROTARY-LOCKED TYPE (TIS.344-1987 STANDARD)
- 99.85%(87) HIGH PURITY ANODIZED ALUMINIUM REFLECTOR WITH TOTAL REFLECTANCE OF 87%(87) FOR NORMAL USAGE.
- SPRING-LOCK TYPE LOUVER FOR EASE OF MAINTENANCE

MODEL NO	WATT	DIMENSION (MM.)		
		L	W	H
F-HL-SLIM120/L	1 X T8 LED.	1225	100	100
F-HL-SLIM220/L	2 X T8 LED.	1225	150	100

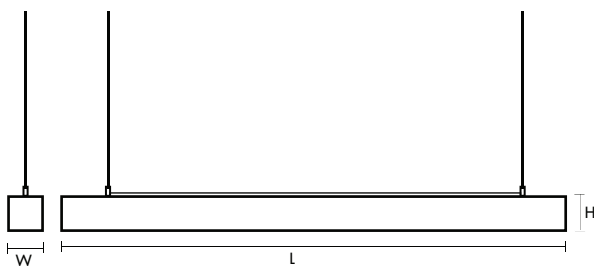

FLUORESCENT

F-XL-287-5S-228V

Slim Pendant Louver Luminaire

HOUSING

- MADE OF ALUMINIUM
- FINISHED WITH POLYESTER POWDER BY TWO -STAGE ELECTROSTATIC METHOD.
- HEAVY DUTY ROTARY-LOCKED TYPE (TIS.344-1987 STANDARD) (GS)
- 99.85% HIGH PURITY ANODIZED ALUMINIUM REFLECTOR WITH TOTAL REFLECTANCE OF 87% (87) FOR NORMAL USAGE.
- ALUMINIUM LOUVER
- INSTALLATION : PENDANT

MODEL NO	WATT	DIMENSION (MM.)		
		L	W	H
F-XL-287-5S-228V	2 X T5 28W	1200	255	60



ສິລິນຍາວ 1 ແມັດ

**F-XL-901SH-228I-LED**

Slim Pendant Louver Luminaire

HOUSING

- Made Aluminium Die-Cast
- Finished with polyester powder by two -stage electrostatic method.
- Heavy duty rotary -locked type (TIS.344-1987 Standard) (GS)
- 99.85% high purity anodized aluminium reflector with Total Reflectance of 87% (87) for normal usage.
- Acrylic Diffuser
- Installation : Pendant

MODEL NO	WATT	DIMENSION (MM.)		
		L	W	H
F-XL-901SH-228I-LED	2 X T5 28W LEDx4 3W(3000K)	148	14	8



ສິລິນຍາວ 1 ແມັດ



TRM-400/WH
Ø12 x H25
LED PAR30, E27
500.-



TRM-400/BK
Ø12 x H25
LED PAR30, E27
500.-



TRM-401/BK
Ø12 x H25
LED PAR30, E27
550.-

SPOTLIGHT

Adjustable Ceiling Spotlight

ALUMINIUM ANODIZED REFLECTOR



TRL-400/BK
Ø12 x H25
LED PAR30, E27
420.-



TRL-400/WH
Ø12 x H25
LED PAR30, E27
420.-



TRL-401
Ø12 x H25
LED PAR30, E27
500.-



TRACKLIGHT

Aadjustable Track light
ALUMINIUM ANODIZED REFLECTOR



TRL-1022/P30
Ø11.4 x H13.4
LED PAR30, E27
600.-



TRL-1031/P38
Ø13 x H14.5
LED PAR38, E27
650.-



TRL-E097/P30/BK
Ø11 x H12
LED PAR30/E27
600.-

TRACKLIGHT

Adjustable Track light
ALUMINIUM ANODIZED REFLECTOR



TRL-A014/WH
Ø9.3 x H12.5
กล่อง W5xL12xH14.7
CDM-TC/G8.5 (MAX 70W)
1,200.-
(ราคาไม่รวมบัลลาสต์)



TRL-A015/WH
Ø11.7 x H15.3
กล่อง W4.5xL12xH14.7
CDM-TD/G12 (MAX 70W)
1,200.-
(ราคาไม่รวมบัลลาสต์)

TRACKLIGHT

Adjustable Track light

ALUMINIUM ANODIZED REFLECTOR





TRM-201

Spot light

HOUSING : ALUMINIUM

PAINTING : BLACK AND WHITE

COMPATIBLE BULB	
	MR16 / GX5.3 50W

LED REPLACEMENT	
	LED-MR16 / GX5.3 5W

380.-



(INCLUDED TRANSFORMER)



TRL-201

Track light

HOUSING : ALUMINIUM

PAINTING : BLACK AND WHITE

COMPATIBLE BULB	
	MR16 / GX5.3 50W

LED REPLACEMENT	
	LED-MR16 / GX5.3 5W

380.-



(INCLUDED TRANSFORMER)



TRM-202

Spot light

HOUSING : ALUMINIUM

PAINTING : BLACK AND WHITE

COMPATIBLE BULB	
	MR16 / GX5.3 50W

LED REPLACEMENT	
	LED-MR16 / GX5.3 5W

380.-



(INCLUDED TRANSFORMER)



TRL-202

Track light

HOUSING : ALUMINIUM

PAINTING : BLACK AND WHITE

COMPATIBLE BULB	
	MR16 / GX5.3 50W

LED REPLACEMENT	
	LED-MR16 / GX5.3 5W

380.-



(INCLUDED TRANSFORMER)

TRM-202/ST

PAINTING : NICKLE SATIN

580.-



TRL-202/ST

PAINTING : NICKLE SATIN

580.-



TRM-203

Spot light

• HOUSING : ALUMINIUM

• PAINTING : BLACK AND WHITE

COMPATIBLE BULB	
	MR16 / GX5.3 50W

LED REPLACEMENT	
	LED-MR16 / GX5.3 5W

380.-



(INCLUDED TRANSFORMER)



TRL-203

Track light

HOUSING : ALUMINIUM

PAINTING : BLACK AND WHITE

COMPATIBLE BULB	
	MR16 / GX5.3 50W

LED REPLACEMENT	
	LED-MR16 / GX5.3 5W

380.-



(INCLUDED TRANSFORMER)



TRM-U30

Spot light

HOUSING : STEEL
PAINTING : WHITE, GREY AND BLACK

360.-



COMPATIBLE BULB	
	PAR30 / E27 100W

LED REPLACEMENT	
	LED-PAR30 / E27 15W



TRL-U30

Track light

HOUSING : STEEL
PAINTING : WHITE, GREY AND BLACK

360.-



COMPATIBLE BULB	
	PAR30 / E27 100W

LED REPLACEMENT	
	LED-PAR30 / E27 15W



TRM-U38

Spot light

HOUSING : STEEL
PAINTING : WHITE, GREY AND BLACK

380.-



COMPATIBLE BULB	
	PAR38 / E27 120W

LED REPLACEMENT	
	LED-PAR38 / E27 22W



TRL-U38

Track light

HOUSING : STEEL
PAINTING : WHITE, GREY AND BLACK

380.-



COMPATIBLE BULB	
	PAR38 / E27 120W

LED REPLACEMENT	
	LED-PAR38 / E27 22W



ภาพรวมหัวจ่าย

TR-1M

300.-/1M

HOUSING : ALUMINIUM
PAINTING : BLACK OR WHITE

TR-2M

600.-/2M

TR-3M

1,000.-/3M



TR-A1

HOUSING : ABS
PAINTING : BLACK OR WHITE

100.-



หัวจ่าย

TR-A2

HOUSING : ABS
PAINTING : BLACK OR WHITE



100.-



TR-A3

HOUSING : ABS
PAINTING : BLACK OR WHITE



140.-



TRACKLIGHT

Adujustable Track light

ALUMINIUM ANODIZED REFLECTOR



LED TRACKLIGHT

OPL-SPOT18

OPL-SPOT28



OPL-TRL18/30 (18W)

OPL-TRL18/40 (18W)

OPL-TRL28/30 (28W)

OPL-TRL28/40 (28W)



Warm White
3000K

Cool Daylight
4000K

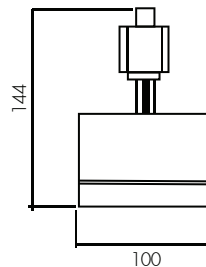



OPL-TRL5/30/WH (5W)
 OPL-TRL5/60/WH (5W)
 OPL-TRL7/30/WH (7W)
 OPL-TRL7/60/WH (7W)

OPL-TRL5/30/BK (5W)
 OPL-TRL5/60/BK (5W)
 OPL-TRL7/30/BK (7W)
 OPL-TRL7/60/BK (7W)

TRACKLIGHT

Adjustable Track light

ALUMINIUM ANODIZED REFLECTOR



Warm White 3000K Cool Daylight 6000K

คุณสมบัติ

- ใช้ Chip LED คุณภาพสูง กระจายแสงทั่วถึง ปราศจากจุดมืด
- เลนส์กระจายแสงที่ออกแบบมาพิเศษ
- โครงสร้างผลิตจากอลูมิเนียมเนื้อดี
- ระบายความร้อนได้ดี
- มีความยืดหยุ่น ปรับได้ทั้งแนวตั้งและแนวนอน
- อายุการใช้งาน 20,000 ชั่วโมง
- มีความยืดหยุ่น ช่วยเน้นสินค้าโชว์ตามมุมต่างๆ



OPL-TRM5/30/WH
 OPL-TRM5/60/WH
 OPL-TRM7/30/WH
 OPL-TRM7/60/WH
 OPL-TRM5/30/WH

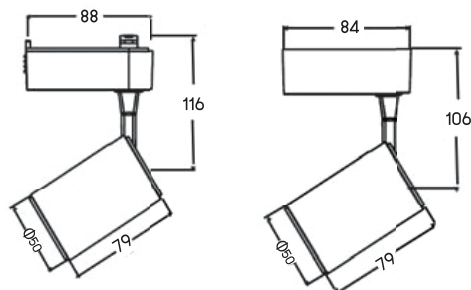



Magnetic



Track line

Surface ultra thin track line for magnetic system

Material : Aluminium + PC
Color : Black/White/Gold

MODEL NO	DIMENSION (mm)		
	L	W	H
LS-UT-MZ200-B-1M	1000	25	5.5
LS-UT-MZ200-B-1.5M	1500	25	5.5
LS-UT-MZ200-B-2M	2000	25	5.5

MODEL NO	
1	LS-UT-MZ203
2	LS-UT-MZ204
3	LS-UT-MZ205
4	LS-UT-MZ207
5	LS-UT-MZ208

Connector

I connector , match with surface line track line LS-UT-MZ200

Material : PC
Color : Black/White

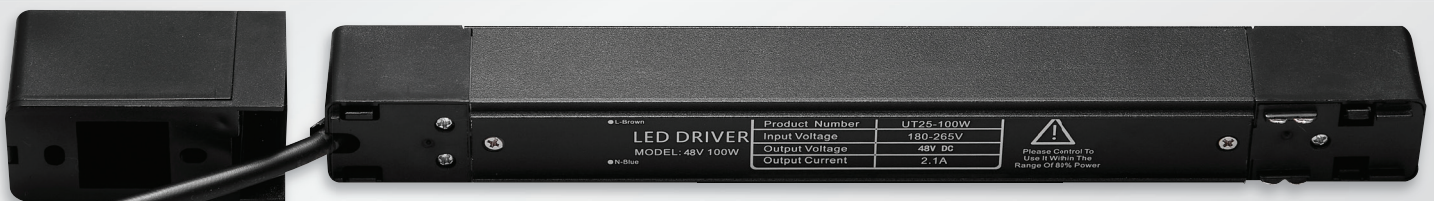
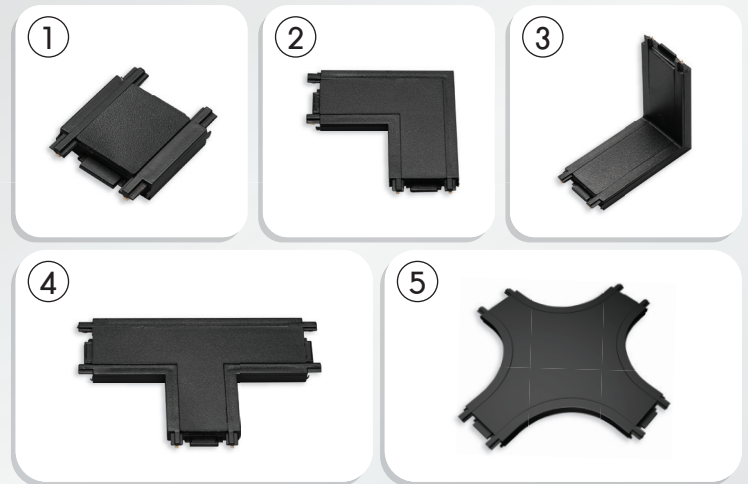

Power Supply

MODEL NO	WATT	DIMENSION (mm)		
		L	W	H
LS-UT-MZ214-100W	100W	260	25	25
LS-UT-MZ214-200W	200W	260	25	25

power supply for LS-MZ200 and LS-MZ201

Input voltage : 220-240V 50/60Hz

Out put Voltage : 48V DC

PFO.5, flicker free, can pass EMC

Material : PC

Color : Black/White



Track Light.

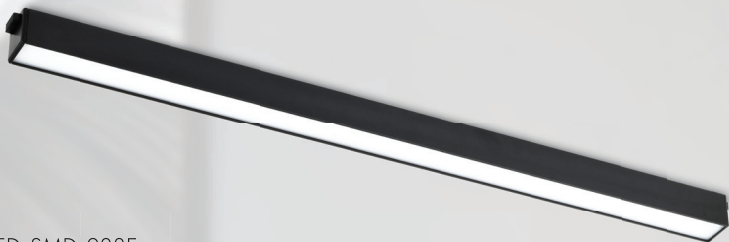

LED SMD 2835
 Material : Aluminum + PC
 Color : Black/White
 Input voltage : 48V DC
 Beam Angle : 120°

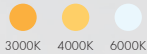

MODEL NO	WATT	DIMENSION (mm)		
		L	W	H
LS-UT038-12W	12W	257	25.5	26
LS-UT038-24W	24W	509	25.5	26
LS-UT038-36W	36W	761	25.5	26
LS-UT038-48W	48W	1013	25.5	26

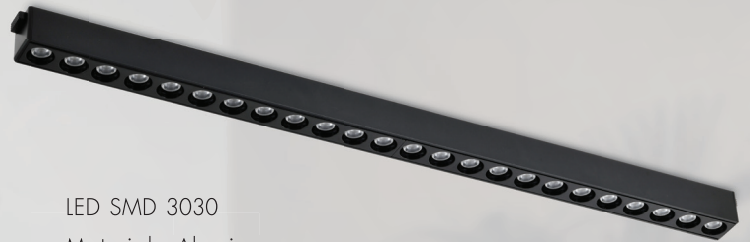

LED SMD 3030
 Material : Aluminum
 + Hight efficient lens
 Color : Black/White
 Input voltage : 48V DC
 Beam Angle : 24°

MODEL NO	WATT	DIMENSION (mm)		
		L	W	H
LS-UT040-12W	12W	257	25.5	26
LS-UT040-24W	24W	509	25.5	26

LED SMD 3030
 Material : Aluminum
 + Hight efficient lens
 Color : Black/White
 Input voltage : 48V DC
 Beam Angle : 24°

LED SMD
 Material : Aluminum
 + Hight efficient lens
 Color : Black/White
 Input voltage : 48V DC

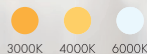

MODEL NO	WATT	DIMENSION (mm)		
		L	W	H
LS-UT042-12W	12W	260	25.5	58
LS-UT042-24W	24W	512	25.5	58



MODEL NO	WATT	DIMENSION (mm)		
		L	W	H
LS-UT034-12W	12W	220	22	112

LED
 Material : Aluminum
 + Hight efficient lens
 Color : Black/White
 Input voltage: 48V DC
 Beam angle: 24°/38°

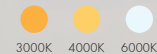

MODEL NO	WATT	DIMENSION (mm)
LS-UT025-7W	7W	∅35 x H90
LS-UT025-12W	12W	∅50 x H125
LS-UT025-20W	20W	∅60 x H146



CEILING LAMP



CW-P-101
E27X2 (GENIE 18 W)
GLASS/STEEL
240-



CW-P-207
E27X2 (GENIE 18 W)
GLASS/STEEL
240.-



CW-P-099
E27X2 (GENIE 18 W)
GLASS/STEEL
240.-



CW-P-023
E27X2 (GENIE 18 W)
GLASS/STEEL
240-



CW-P-088
E27X2 (GENIE 18 W)
GLASS/STEEL
240-



CW-P-036
E27X2 (GENIE 18 W)
GLASS/STEEL
240-



CW-P-032
E27X2 (GENIE 18 W)
GLASS/STEEL
240-



CW-P-048
E27X2 (GENIE 18 W)
GLASS/STEEL
240-



CW-P-201
E27X2 (GENIE 18 W)
GLASS/STEEL
240-

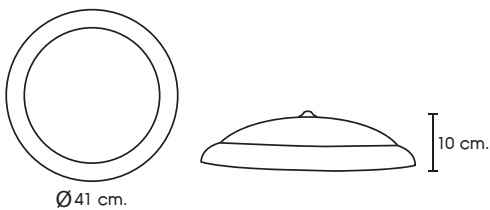

ใช้ร่วมกับอุปกรณ์ สำหรับ 32 วัตต์ หรือเปลี่ยนขั้ว E27 สำหรับใส่หลอดประหยัดไฟ

CEILING LAMP



CLG-5001/(32,40)

/32 G10Q/32W, E27x2 (GENIE 18W) 300.-
/40 G10Q/40W, E27x3 (GENIE 18W) 500.-



CLG-5002/(22,32,40)

/22 E27 (GENIE 18) 200.-
/32 G10Q/32W, E27x2 (GENIE 18W) 300.-
/40 G10Q/40W, E27x3 (GENIE 18W) 500.-

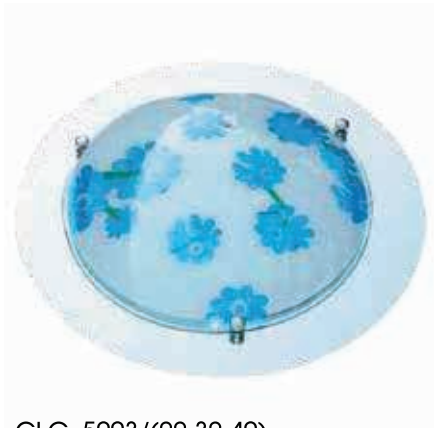

CLG-5003/(22,32,40)

/22 E27 (GENIE 18) 200.-
/32 G10Q/32W, E27x2 (GENIE 18W) 300.-
/40 G10Q/40W, E27x3 (GENIE 18W) 500.-



CLG-5004/(22,32,40)

/22 E27 (GENIE 18) 200.-
/32 G10Q/32W, E27x2 (GENIE 18W) 300.-
/40 G10Q/40W, E27x3 (GENIE 18W) 500.-



CLG-5005/(22,32,40)

/22 E27 (GENIE 18) 200.-
/32 G10Q/32W, E27x2 (GENIE 18W) 300.-
/40 G10Q/40W, E27x3 (GENIE 18W) 500.-



CLG-5006/(22,32,40)

/22 E27 (GENIE 18) 200.-
/32 G10Q/32W, E27x2 (GENIE 18W) 300.-
/40 G10Q/40W, E27x3 (GENIE 18W) 500.-

/22 Ø30 cm.
/32 Ø40 cm.
/40 Ø65 cm.

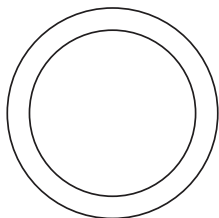

/22 >12 cm.
/32 >13 cm.
/40 >16 cm.



G10Q/32W



E27

CEILING LAMP

ใช้ร่วมกับอุปกรณ์สำหรับ 32 วัตต์หรือเปลี่ยนหัว E27 สำหรับใส่หลอดประหยัดไฟได้

Material
Glass|Steel



วัสดุคุณภาพ ให้แสงสว่างทั่วถึง

CEILING LAMP

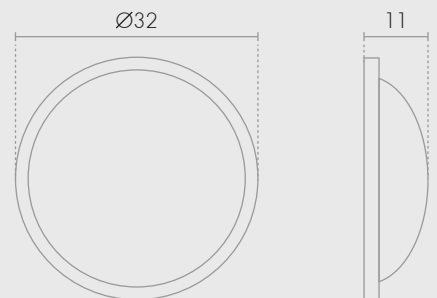

MODEL	HOLDER	COLOR	DIMENSION	Material	IP	PRICE
C-803	E27x2	White	Ø32 x H11 cm	Glass Steel	40	600.-

CEILING LAMP



C-ME00/32

E27x2 : Ø35 X H10 cm

360.-

Acrylic | Steel



C-ME00/22

E27x1 : Ø29 X H8 cm

300.-

Acrylic | Steel



C-ME09/D380

E27x1 : Ø40 X H10 cm

360.-

Acrylic | Steel



C-S811

E27x2 : Ø43 X H10 cm

500.-

Glass | Steel

CEILING LAMP



C-A200

E27x2 : W40 x D40 X H10 cm

420.-

Acrylic | Steel



C-A400

E27x2 : W36 x D36 X H10 cm

420.-

Acrylic | Steel



F-LR32

E27x1 : W38.2 x D38.2 X H7 cm

700.-

Acrylic | Steel

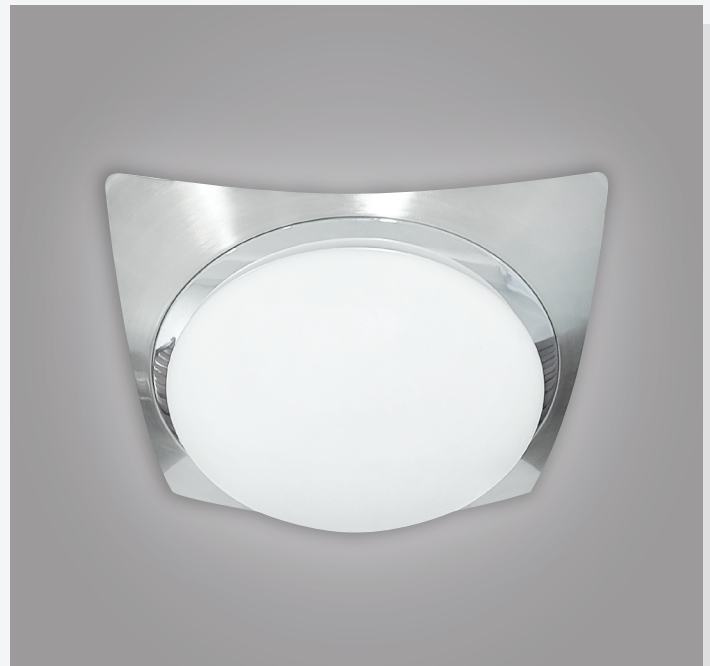

C-2007A/13

E27x1 : W34 x D34 X H12 cm

600.-

Glass | Steel

CEILING LAMP



C-2004

E27x2 : Ø29 X H7.5 cm

500.-

Glass | Steel



C-1001

E27x2 : Ø23 X H8 cm

400.-

Glass | Steel



C-028

E27x2 : Ø28 X H7 cm

480.-

Glass | Steel



C-015-10

E27x2 : Ø23 X H7 cm

400.-

Glass | Steel

Material
Glass | Steel



“ ดีไซน์เรียบง่าย แต่เติมเต็มความหรูหราให้ทุกพื้นที่ ”

CEILING LAMP

MODEL	HOLDER	COLOR	DIMENSION	Material	IP	PRICE
C-802	E27x2	White	Ø29.5 x H9 cm	Glass Steel	40	500.-



C-8117/S

E27x1 : Ø20 X H10 cm

240.-

Glass | Steel



C-8117/L

E27x2 : Ø25 X H10.5 cm

300.-

Glass | Steel

Central Unit



Figure C

Figure B

Figure A

Diagram



CCU 12V Series for Remote Lamp 12V

Model	Power (Wattage)	Battery Capacity	Back up Time (hrs.)	Dimension (mm.)			Weight (kgs.)	Figure
				L	W	H		
CCU 12-30	30	12V-7 Ah.	2	290	80	160	4,30	A
CCU 12-50	50	12V-12 Ah.		290	110	160	6.60	
CCU 12-60	60	12V-15 Ah.		340	100	220	8.40	
CCU 12-80	80	12V-18 Ah.		340	110	220	9.60	
CCU 12-110	110	12V-24 Ah.		340	160	235	13.20	
CCU 12-120	120	12V-26 Ah.		340	160	235	13.25	
CCU 12-180	180	12V-40 Ah.	400	200	250	19.20	B	
CCU 12-250	250	12V-26 Ah.x2	500	200	250	30.60		
CCU 12-300	300	12V-65 Ah.	500	200	250	33.90		
CCU 12-350	350	12V-40 Ah.x4	500	250	300	42.00		
CCU 12-470	470	12V-100 Ah.	500	250	300	46.00	C	
CCU 12-550	550	12V-130 Ah.	620	350	750	74.00		
CCU 12-620	620	12V-130 Ah.	620	350	750	76.00		
CCU 12-720	720	12V-150 Ah.	620	350	750	77.00		
CCU 12-850	850	12V-200 Ah.	620	350	750	99.50		
CCU 12-1000	1000	12V-200 Ah.	620	350	750	99.50		
CCU 12-1100	1100	12V-130 Ah.x2	620	400	950	119.00		
CCU 12-1400	1400	12V-150 Ah.x2	620	400	950	125.00		
CCU 12-1900	1900	12V-200 Ah.x2	620	400	950	171.80		

SG209CD3LED(ABS)

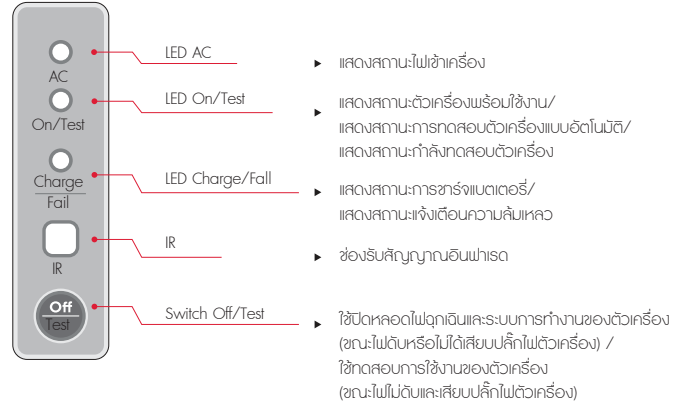

FEATURES

หลอดไฟ

- ใช้หลอดไฟ LED 9 วัตต์ คุณภาพแสงสว่างสูงแต่ใช้พลังงานไฟฟ้าน้อย ช่วยประหยัดพลังงานไฟฟ้ายของหลอด และมีอายุการใช้งานยาวนานกว่า 50,000 ชั่วโมง

แบตเตอรี่

- ใช้ Lithium Iron Phosphate (LiFePO4) 3.2V-6000mAh สามารถชาร์จไฟได้ 3 ชม. ช็อต น้ำหนักเบา อายุการใช้งานยาวนาน และให้พลังงานสูง ก่อให้เกิดมลภาวะน้อย

ฟังก์ชัน

- ตรวจสอบความผิดปกติที่สำคัญของตัวเครื่อง (Auto Check) เช่น แบตเตอรี่, หลอดไฟ, ฝา, วงจรแสงสว่าง และระบบการชาร์จแบตเตอรี่
- การตั้งเวลาทดสอบ อัตโนมัติทุก 1 เดือน 60 วันทำการ, ทุก 1 ปี 120 นาที (Auto Test) ตามมาตรฐาน วสท.021004-22 เปิด-ปิด ฟังก์ชันด้วยรีโมท
- สามารถทดสอบการทำงานที่ตัวเครื่องได้ (Manual Test)
- การควบคุมการทดสอบระยะไกลด้วย (Remote Test) ทดสอบการทำงานเครื่อง โดยกดรีโมททดสอบ 5 วินาที, 30 นาที และ 60 นาที

ระบบการป้องกัน

- อุปกรณ์ป้องกันกระแสเกิน AC Fuse, DC Fuse
- อุปกรณ์ป้องกันฟ้าผ่า (Surge Protection)
- ระดับป้องกันน้ำและฝุ่น (IP20)

PRODUCT OVERVIEW

โคมไฟฉุกเฉินที่มาพร้อมกับระบบ Auto Check ที่คอยตรวจเช็คสมรรถนะตัวเครื่อง และแจ้งเตือนความผิดปกติอัตโนมัติ ในทุกจุดสำคัญของตัวเครื่องเช่น แบตเตอรี่, หลอดไฟ, ฝา, วงจรแสงสว่าง และระบบการชาร์จแบตเตอรี่ ซึ่งจะแจ้งเตือนเมื่อเครื่องไม่พร้อมใช้งาน เพื่อเพิ่มความมั่นใจในการใช้งาน ในกรณีที่ไฟดับกันทันทีที่มาจากกระแสไฟฟ้าขัดข้อง และใช้แบตเตอรี่ชนิด Lithium Iron Phosphate (LiFePO4) ที่มีน้ำหนักเบา อายุการใช้งานยาวนาน และให้พลังงานสูง ก่อให้เกิดมลภาวะน้อย ระบบการชาร์จแบตเตอรี่นวัตกรรมใหม่ที่เรียกว่า 3 Steps Charger (เลขอนุสิทธิบัตร 15955) ที่เหนือกว่าระบบชาร์จอื่น ช่วยปกป้องกระบวนการชาร์จแบตเตอรี่อย่างสมบูรณ์

ระบบการแจ้งเตือน

- แจ้งเตือนสถานะเครื่องไม่พร้อมใช้
- แจ้งเตือนไฟ AC Input ไม่เข้าเครื่อง และแจ้งเตือนวงจร Rectifier ไม่ทำงาน
- แจ้งเตือนทุกครั้งเมื่อระบบได้ทำการทดสอบแบตเตอรี่อัตโนมัติ (Auto Test) แล้วพบว่าโคมไฟสำรองไฟแสงสว่างได้น้อยกว่า 120 นาที (Battery Fail) LED กระพริบ 3 ครั้ง ทุกๆ 15 วินาที
- แจ้งเตือนการชาร์จแบตเตอรี่เกิดปัญหา (Charging Fail) LED กระพริบ 4 ครั้ง ทุกๆ 15 วินาที
- แจ้งเตือนเมื่อระบบพบความผิดปกติของระบบแสงสว่าง (Lighting Fail) LED กระพริบ 5 ครั้ง ทุกๆ 15 วินาที

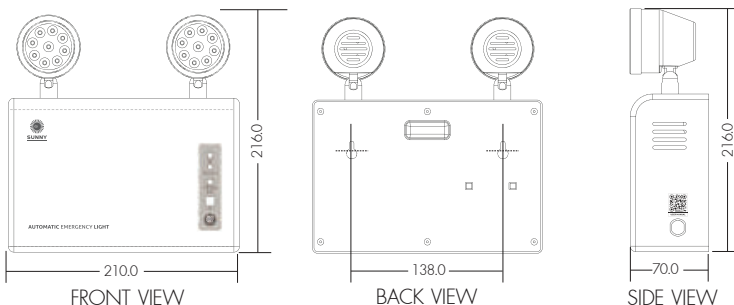

SPECIFICATIONS

INPUT VOLTAGE	230V / 50Hz
LED LAMP POWER	9W / BULB
COLOR TEMPERATURE	Daylight (6000K ±250K)
RATED BEAM ANGLE	36°
BATTERY TYPE/SIZE	Lithium Iron Phosphate (LiFePO4) 3.2V-6000mAh
CHARGING METHOD	3 Steps Charger System
CHARGING CURRENT	0.1C
CHARGING TIME	10-15HRS.
BACKUP TIME	3 HRS.
HOUSING	Plastic ABS Casing
DIMENSION (LxHxW)	210 x 70 x 216 mm
WEIGHT	1.24 KG.



PRODUCT OVERVIEW

- โคมไฟฟ้าแสงสว่างฉุกเฉิน CU209CD4 ใช้หลอด LED SMD Type 12 โวลท์ กำลังพิกัด 9 วัตต์ จำนวน 2 หัวโคมในการให้แสงสว่าง
- ควบคุมการทำงานด้วย Microcontroller 8 bit สามารถสั่งงานได้ทั้ง จากปุ่ม Function Test ที่ตัวเครื่องและจาก Remote Testing
- ตัวกล่องผลิตจากแผ่นเหล็ก Electro-Galvanized หนา 1 มม. พื้นและ เคลือบด้วยระบบ Epoxy powder Coated and Stove Enamel ป้องกัน การเกิดสนิมของโลหะได้เป็นอย่างดี

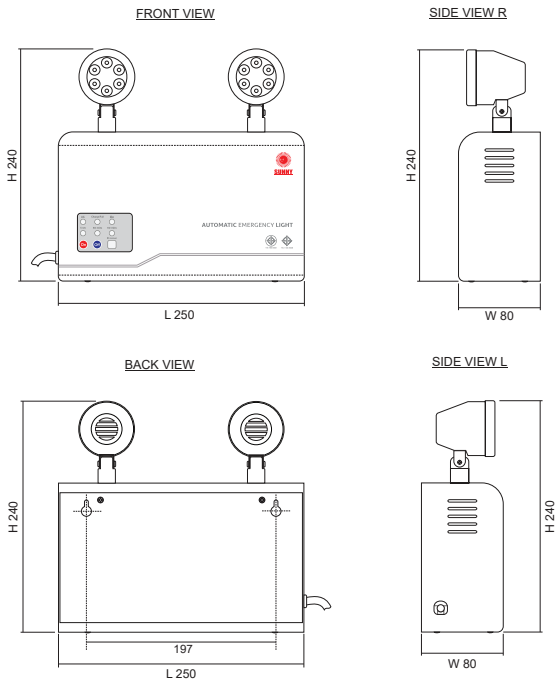

INDICATORS

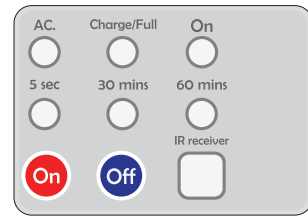

- LED AC. ▶ แสดงสถานะไฟเข้าเครื่อง
- LED Charge/Full ▶ แสดงสถานะการชาร์จแบตเตอรี่
- LED On ▶ แสดงสถานะตัวเครื่องพร้อมใช้งาน
- LED 5 sec ▶ แสดงสถานะการทดสอบตัวเครื่อง 5 วินาที
- LED 30 mins ▶ แสดงสถานะการทดสอบตัวเครื่อง 30 นาที
- LED 60 mins ▶ แสดงสถานะการทดสอบตัวเครื่อง 60 นาที
- Switch On ▶ ใช้ เปิด หลอดไฟ (ขณะไม่ได้สียบปลั๊กไฟ)
- Switch Off ▶ ใช้ ปิด หลอดไฟ (ขณะไม่ได้สียบปลั๊กไฟ)
- IR receiver ▶ ช่องรับสัญญาณอินฟราเรด

FEATURES

- หลอด LED มีอายุการใช้งานที่ยาวนานกว่า 50,000 ชั่วโมง
- ประจุแบตเตอรี่แบบอัตโนมัติ โดยการควบคุมแรงดันและกระแสไฟฟ้า Constant Voltage & Limit Current
- วงจรป้องกันการชาร์จแบตเตอรี่เกินเป็นสาเหตุทำให้แบตเตอรี่เกิดการบวม
- วงจรป้องกันการไหลแบตเตอรี่จนหมดประจุไฟฟ้า ทำให้อายุแบตเตอรี่ยาว นานขึ้น
- วงจรป้องกันไฟตก เมื่อเกิดความผิดปกติของระบบจ่ายกำลังหลัก เกิดไฟตกในช่วง 140-160VAC ตัวเครื่องจะสั่งงานอัตโนมัติให้ แสงสว่างฉุกเฉินทันที
- สามารถทดสอบการทำงานได้ด้วยรีโมทคอนโทรล (Remote Testing)
- มีฟังก์ชันการทดสอบการทำงานอัตโนมัติ (Automatic Testing System) ทดสอบทุกๆ 30 วัน ระบบจะทดสอบเองอัตโนมัติเป็นเวลา 30 นาที
- ระบบแจ้งเตือนให้ชาร์จแบตเตอรี่ด้วยเสียง (Battery Checker)

SPECIFICATIONS

INPUT VOLTAGE	220V / 50Hz
LED LAMP POWER	9W / BULB
COLOR TEMPERATURE	3000K ± 250K (WARM WHITE) 6000K ± 250K (COOL WHITE)
RATED BEAM ANGLE	36°
BATTERY TYPE/SIZE	SEALED LEAD-ACID 12V 5Ah
BATTERY CUT-OFF VOLTAGE	1.60-1.75V / CELL
CHARGING MODE	CONSTANT VOLTAGE&LIMIT CURRENT
CHARGING CURRENT	500mA
CHARGING TIME	10-15HRS.
BACKUP TIME	4 HRS.
HOUSING	ELECTRO-GALVANIZED STEEL SHEET, 1mm. THICK WITH EPOXY POWDER COATING.
DIMENSION (LxHxW)	250 X 240 X 80 MM.
WEIGHT	4 KG.

SLS1-10LED/D-RT (DOUBLE-SIDE)



SPECIFICATIONS

INPUT VOLTAGE	220V / 50Hz
INPUT CURRENT (MAX)	0.056A@220VAC
INPUT POWER (MAX)	11.20W
INPUT POWER (STANDBY)	7.04W
LED COLOR TEMPERATURE	6,500K
LAMP CURRENT (AC)	0.670A
LAMP CURRENT (BATTERY)	0.650A@1.2V/CELL
BATTERY	NiMH 1,800mAh(1.2Vx3)
CHARGE CURRENT (MAX)	0.180A
CHARGE TERMINATING VOLTAGE	1.4V/CELL
CHAGING TIME	12 HRS.
BATTERY LOW VOLTAGE CUT-OFF	1.0V/CELL
BACKUP TIME	2 HRS.
DIMENSION	400 x 200 x 60MM.
WEIGHT	1,4 KG.

PRODUCT OVERVIEW

- ป้ายไฟทางออกฉุกเฉิน รุ่น SLS1-10LED/S
- ลักษณะการติดตั้ง การติดตั้งแบบฝังและเพดาน
- หลอดไฟที่ใช้เป็นหลอด LED มีประสิทธิภาพสูง
- ประหยัดพลังงานได้มากกว่าระบบเดิมที่ใช้หลอดฟลูออเรสเซนต์ถึง 6 เท่า
- มีอายุการใช้งานที่ยาวนานกว่าถึง 7 เท่า
- ใช้แบตเตอรี่ชนิด NI-MH (NIKLE METAL HYDRIDE) ที่มีขนาดเล็ก
- แบตเตอรี่ SEALED LEAD ACID แบตเตอรี่ 2-3 เท่า
- สามารถสำรองไฟได้นานถึง 2 ชั่วโมง
- ใช้แผ่นอะคริลิกโปร่งแสงชนิด ESD ที่มีคุณสมบัติพิเศษโดยทำให้ลำแสงของหลอดไฟกระจายทั่วทั้งแผ่นอย่างสม่ำเสมอและการกระจายแสงมีความคงทนและยาวนาน
- ตัวกล่องทำจากเหล็กคุณภาพ ปีนและพับขึ้นรูป เคลือบกันสนิม พ่นด้วยสีฝุ่นคุณภาพสูงและอบด้วยความร้อน

FEATURES

- ใช้หลอด LED กำลังสูง พิกัด 10 วัตต์ ในการให้แสงสว่าง
- มีอายุการใช้งานที่ยาวนานกว่า 50,000 ชั่วโมง
- ให้แสงคงที่ยาวนานกว่า 2 ชั่วโมง
- ประจุแบตเตอรี่แบบอัตโนมัติ โดยการควบคุมแรงดันและกระแสไฟฟ้า CONSTANT VOLTAGE&LIMIT CURRENT
- รองรับการทดสอบการทำงานได้ด้วยรีโมทคอนโทรล (ออฟชั่น)
- ได้รับมาตรฐานอุตสาหกรรม มอก.1102-2538 ,มอก.1995-2551
- รับประกันแผงวงจรหลัก 5 ปี และแบตเตอรี่ 3 ปี

INSTALLATION

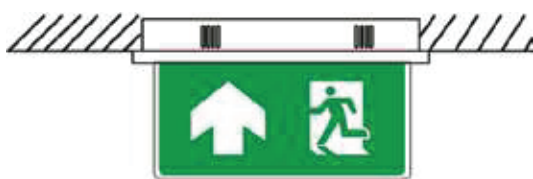

Ceiling Recessed

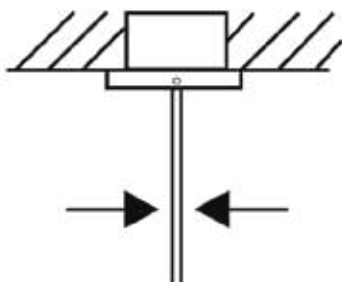

DIMENSION (MM)

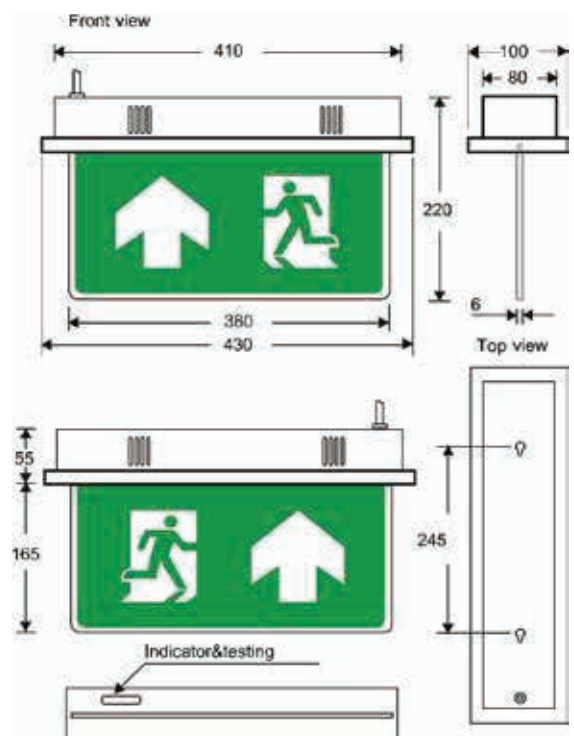

SLS1-10LED/S-RT (SINGLE-SIDE)



SPECIFICATIONS

INPUT VOLTAGE	220V / 50Hz
INPUT CURRENT (MAX)	0.056A@220VAC
INPUT POWER (MAX)	11.20W
INPUT POWER (STANDBY)	7.04W
LED COLOR TEMPERATURE	6,500K
LAMP CURRENT (AC)	0.670A
LAMP CURRENT (BATTERY)	0.650A@1.2V/CELL
BATTERY	NiMH 1,800mAh(1.2Vx3)
CHARGE CURRENT (MAX)	0.180A
CHARGE TERMINATING VOLTAGE	1.4V/CELL
CHAGING TIME	12 HRS.
BATTERY LOW VOLTAGE CUT-OFF	1.0V/CELL
BACKUP TIME	2 HRS.
DIMENSION	430 x 220 x 100MM.
WEIGHT	1.78 KG.

PRODUCT OVERVIEW

- บ้ายไฟทางออกฉุกเฉิน รุ่น SLS1-10LED/D
- สามารถติดตั้งแบบผนังและเพดาน
- หลอดไฟที่ใช้เป็นหลอด LED มีประสิทธิภาพสูง
- ประหยัดพลังงานได้มากกว่าระบบเดิมที่ใช้หลอดฟลูออโรสเซนต์ถึง 6 เท่า
- มีอายุการใช้งานที่ยาวนานกว่าถึง 7 เท่า
- ใช้แบตเตอรี่ชนิด NI-MH (NIKLE METAL HYDRIDE) ที่มีขนาดเล็ก
- แบตเตอรี่ SEALED LEAD ACIC แบตเตอรี่ 2-3 เท่า
- สามารถสำรองไฟได้นานถึง 2 ชั่วโมง
- ใช้แผ่นอะคริลิกโปร่งแสงชนิด ESD ที่มีคุณสมบัติพิเศษช่วยลดการกระจ่ายแสงมีความคงทนและยาวนาน
- ตัวกล่องทำจากเหล็กคุณภาพ นี้มและพับขึ้นรูป เคลือบกันสนิม พ่นด้วยสีฝุ่นคุณภาพสูงและอบด้วยความร้อน

FEATURES

- ใช้หลอด LED กำลังสูง พิกัด 10 วัตต์ ในการให้แสงสว่าง
- มีอายุการใช้งานที่ยาวนานกว่า 50,000 ชั่วโมง
- ให้แสงคงที่ยาวนานกว่า 2 ชั่วโมง
- ประจุแบตเตอรี่แบบอัตโนมัติ โดยการควบคุมแรงดันและกระแสไฟฟ้า CONSTANT VOLTAGE&LIMIT CURRENT
- รองรับการทดสอบการทำงานได้ด้วยวิธีโทคอลโทรล (ออฟชั่น)
- ใต้รับมาตรฐานอุตสาหกรรม มอก.1102-2538 ,มอก.1995-2551
- รับประกันแผงวงจรหลัก 5 ปี และแบตเตอรี่ 3 ปี

INSTALLATION

Ceiling Type



Wall Type



DIMENSION (MM)

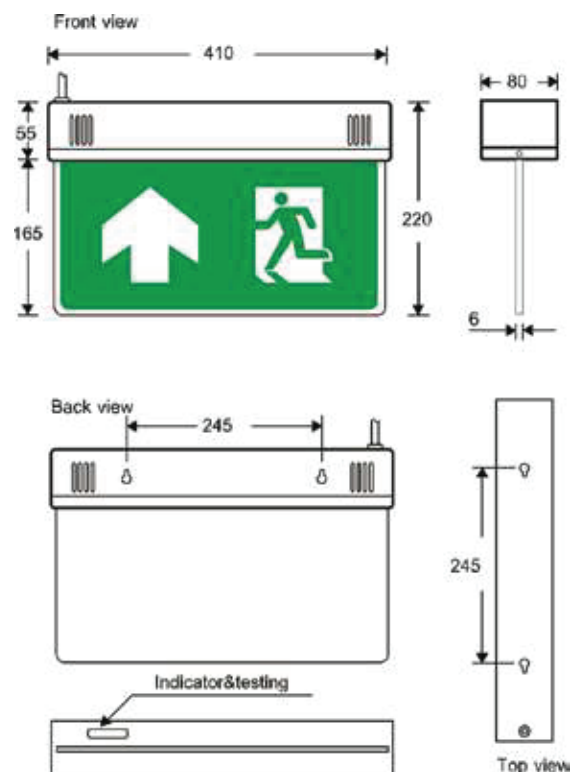

EXS1-10LED/S-RT (SINGLE-SIDE)



SPECIFICATIONS	
INPUT VOLTAGE	220V / 50Hz
INPUT CURRENT (MAX)	0.056A@220VAC
INPUT POWER (MAX)	11.20W
INPUT POWER (STANDBY)	7.04W
LED COLOR TEMPERATURE	6,500K
LAMP CURRENT (AC)	0.670A
LAMP CURRENT (BATTERY)	0.650A@1.2V/CELL
BATTERY	NiMH 1,800mAh(1.2Vx3)
CHARGE CURRENT (MAX)	0.180A
CHARGE TERMINATING VOLTAGE	1.4V/CELL
CHARGING TIME	12 HRS.
BATTERY LOW VOLTAGE CUT-OFF	1.0V/CELL
BACKUP TIME	2 HRS.
DIMENSION	400 x 200 x 60MM.
WEIGHT	1.6 KG.

INSTALLATION

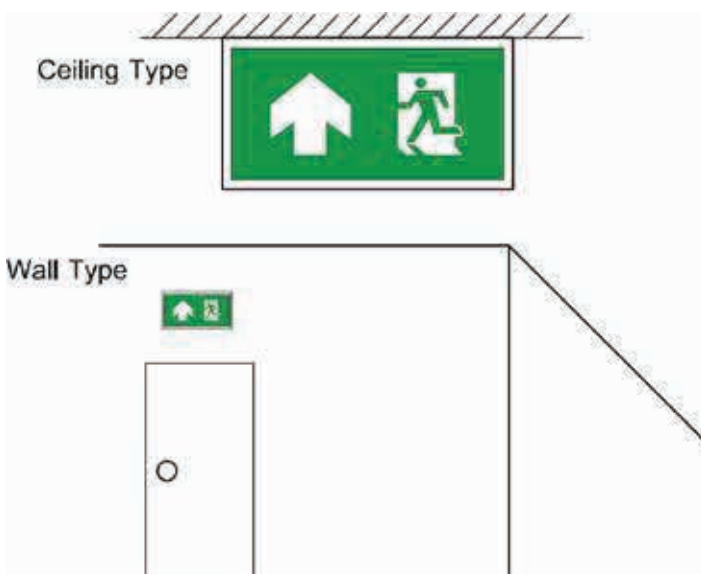

DIMENSION (MM)

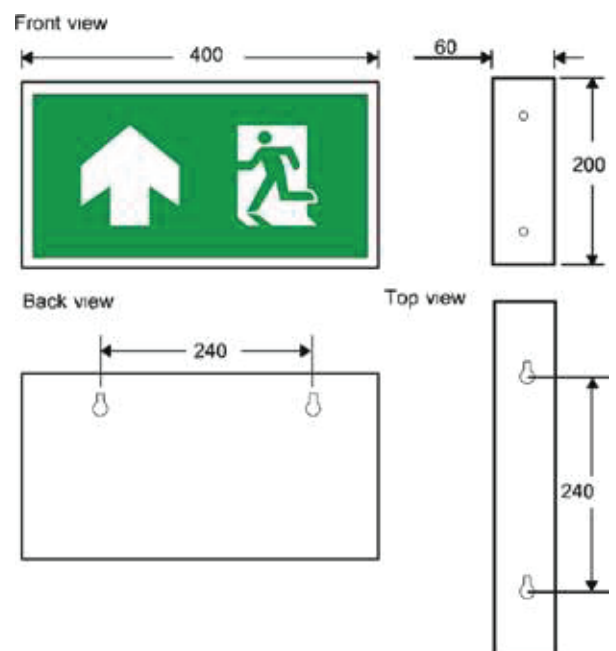

PRODUCT OVERVIEW

- ป้ายไฟทางออกฉุกเฉิน รุ่น EXS1-10LED/S
- สามารถติดตั้งแบบผนังและเพดาน
- หลอดไฟที่ใช้เป็นหลอด LED มีประสิทธิภาพสูง
- ประหยัดพลังงานได้มากกว่าระบบเดิมที่ใช้หลอดฟลูออโรสเซนต์ถึง 6 เท่า
- มีอายุการใช้งานที่ยาวนานกว่าถึง 7 เท่า
- ใช้แบตเตอรี่ชนิด NI-MH (NIKLE METAL HYDRIDE) ที่มีขนาดเล็ก
- แบตเตอรี่ SEALED LEAD ACID แบตเตอรี่ 2-3 เท่า
- สามารถสำรองไฟได้นานถึง 2 ชั่วโมง
- ใช้แผ่นอะคริลิกโปร่งใสที่มีคุณสมบัติพิเศษช่วยให้แสงของหลอดไฟกระจายทั่วทั้งแผ่นอย่างสม่ำเสมอและการกระจายแสงมีความคงทนและยาวนาน
- ตัวกล่องทำจากเหล็กคุณภาพ เบาและมันวาวรูป เคลือบกันสนิม พื้นด้วยสีฝุ่นคุณภาพสูงและอบด้วยความร้อน

FEATURES

- ใช้หลอด LED กำลังสูง พิกัด 10 วัตต์ ในการให้แสงสว่าง
- มีอายุการใช้งานที่ยาวนานกว่า 50,000 ชั่วโมง
- ให้แสงสว่างที่ยาวนานกว่า 2 ชั่วโมง
- ประจุแบตเตอรี่แบบอัตโนมัติ โดยการควบคุมแรงดันและกระแสไฟฟ้า CONSTANT VOLTAGE&LIMIT CURRENT
- รองรับการผลิตสอบการทำงานได้ด้วยรีโมทคอนโทรล (ออฟชั่น)
- ได้รับมาตรฐานอุตสาหกรรม มอก.1102-2538 ,มอก.1995-2551
- รับประกันแผงวงจรหลัก 5 ปี และแบตเตอรี่ 3 ปี

EXS1-10LED/D-RT (DOUBLE-SIDE)



SPECIFICATIONS

INPUT VOLTAGE	220V / 50Hz
INPUT CURRENT (MAX)	0.056A@220VAC
INPUT POWER (MAX)	11.20W
INPUT POWER (STANDBY)	7.04W
LED COLOR TEMPERATURE	6,500K
LAMP CURRENT (AC)	0.670A
LAMP CURRENT (BATTERY)	0.650A@1.2V/CELL
BATTERY	NiMH 1,800mAh(1.2Vx3)
CHARGE CURRENT (MAX)	0.180A
CHARGE TERMINATING VOLTAGE	1.4V/CELL
CHAGING TIME	12 HRS.
BATTERY LOW VOLTAGE CUT-OFF	1.0V/CELL
BACKUP TIME	2 HRS.
DIMENSION	400 x 200 x 60MM.
WEIGHT	1,4 KG.

PRODUCT OVERVIEW

- ป้ายไฟทางออกฉุกเฉิน รุ่น EXS1-10LED/S
- สามารถติดตั้งแบบผนังและเพดาน
- หลอดไฟที่ใช้เป็นหลอด LED มีประสิทธิภาพสูง
- ประหยัดพลังงานได้มากกว่าระบบเดิมที่ใช้หลอดฟลูออโรสเซนต์ถึง 6 เท่า
- มีอายุการใช้งานที่ยาวนานกว่าถึง 7 เท่า
- ใช้แบตเตอรี่ชนิด NI- MH (NIKLE METAL HYDRIDE) ที่มีขนาดเล็ก
- แบตเตอรี่ SEALED LEAD ACID แบตเตอรี่ 2-3 เท่า
- สามารถสำรองไฟได้นานถึง 2 ชั่วโมง
- ใช้แผ่นอะคริลิกโปร่งใสที่มีคุณสมบัติพิเศษโดยทำให้ค่าแสงของหลอดไฟกระจายทั่วทั้งแผ่นอย่างสม่ำเสมอและการกระจายแสงมีความคงทนและยาวนาน
- ตัวกล่องทำจากเหล็กคุณภาพ เบาและพับขึ้นรูป เคลือบกันสนิม พ่นด้วยสีฝุ่นคุณภาพสูงและอบด้วยความร้อน

FEATURES

- ใช้หลอด LED กำลังสูง พัดตัด 10 วัตต์ ในการให้แสงสว่าง
- มีอายุการใช้งานที่ยาวนานกว่า 50,000 ชั่วโมง
- ให้แสงคงที่ยาวนานกว่า 2 ชั่วโมง
- ประจุแบตเตอรี่แบบอัตโนมัติ โดยการควบคุมแรงดันและกระแสไฟฟ้า CONSTANT VOLTAGE&LIMIT CURRENT
- รองรับการผลิตสอบการทำงานได้ด้วยรีโมทคอนโทรล (ออฟชั่น)
- ได้รับมาตรฐานอุตสาหกรรม มอก.1102-2538 ,มอก.1995-2551
- รับประกันแผงวงจรหลัก 5 ปี และแบตเตอรี่ 3 ปี

INSTALLATION

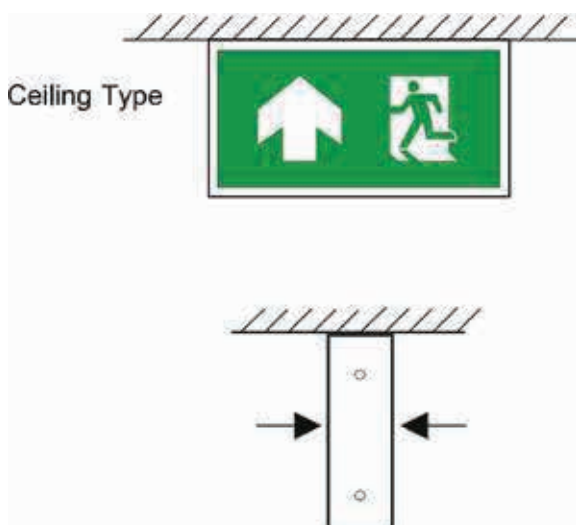

DIMENSION (MM)

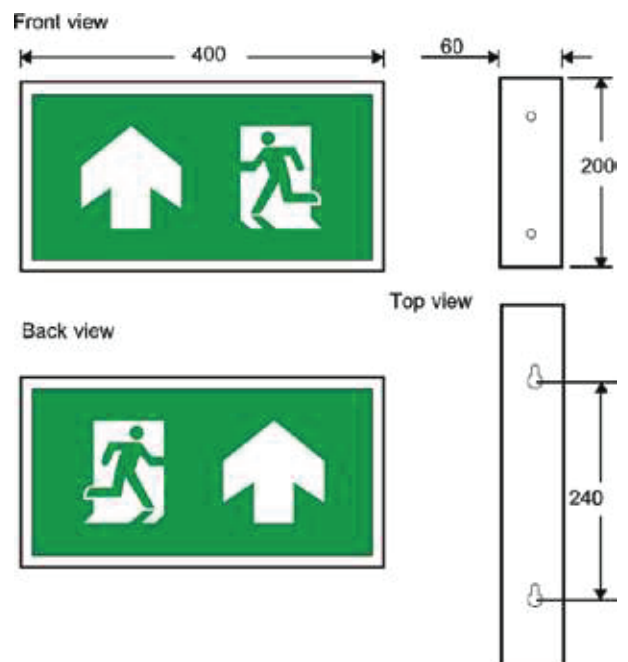

EMERGENCY STANDARD SYMBOL LIGHT



EF-001



EF-002



EF-003



EF-004



EF-005



EF-006



EF-007



EF-008



EF-009



EF-010



EF-011



EF-012



EF-013



EF-014



EF-015



EF-016



EF-017



EF-018



EF-019



EF-020



EF-021



EF-022



EF-023



EF-024



EF-025



EF-026



EF-027



EF-028

DECORATIVE LAMP



Ceiling & Hanging

เราคัดสรรโคมไฟ ตกแต่งบ้านและคอนโด้อย่างครบวงจร
ทุกสไตล์ เพื่อคุณและคนที่คุณรัก. แต่งบ้านคุณให้สวย
เหมือนโรงแรมหรู



HL-BELLA 2,000.-



HL-ZOEY 1,700.-



HL-PAZ 2,100.-



HL-ATOM/BK 2,300.-



HL-REX/WH 2,800.-



HL-MONIX/WH 1,600.-



HL-MONIX/BK 1,600.-



HL-DOOZY/BK 2,500.-



HL-DOOZY/PG 3,900.-



HL-KENTY/WH 1,600.-



HL-MUZZLE/BK 850.-



HL-MUZZLE/PG 1,000.-



HL-MIFFI/PG 1,400.-



HL-ATMOS/BK 1,600.-





HL-ARIS-39/BK 1,300.-



HL-PEAR/PG 900.-



HL-PEAR/BK 700.-



HL-HOLD/AB 700.-



HL-DIAMOND-38/BK 2,000.-



HL-DIAMOND-50/BK 3,000.-



HL-DIAMOND-68/BK 7,000.-



HL-ALFA/BK 1,000.-



HL-ALFA/WH 1,000.-



HL-BETA/BK 1,000.-



HL-BETA/WH 1,000.-



HL-CELTA/BK 1,000.-



HL-CELTA/WH 1,000.-



HL-TOMSON/BK-36 1,400.-



HL-TOMSON/BK-46 2,200.-





HL-SEMI50/CR 10,000.-



HL-SEMI50/BK 9,000.-



HL-COLUME/WH 5,000.-



HL-COLUME/BK 5,000.-



HL-HUD/RD 9,700.-



HL-BOSTON/A 3,200.-



HL-BOSTON/B/BK 1,200.-



HL-PIXX/PG 1,300.-



HL-CAPSULE/PG 1,000.-



HL-GUS/PG 1,300.-



HL-UTAH 1,200.-



HL-SEMI30/CR 2,500.-



HL-SEMI30/BK 5,000.-



HL-ETHAN/PG 1,900.-





HL-150/H1 2,000.-



HL-329/BL 1,200.-



HL-329/RD 1,200.-



HL-329/WH 1,200.-



HL-329/YW 1,200.-



HL-0106/BL 900.-



HL-0106/GN 900.-



HL-87489-FARGO 2,000.-



HL-3004/H1/BW 1,000.-



HL-3004/H1/YW 1,000.-



HL-3004/H1/GN 1,000.-



HL-3004/H1/WH 1,000.-



HL-3004/H1/OR 1,000.-



HL-3004/H1/RD 1,000.-



HL-83202-TROY 1,000.-



HL-1200-230 1,000.-



HL-711 900.-



HL-713 900.-



HL-1995/H1 2,000.-



HL-3054/H1 1,600.-





HL-MUZZIE-3/BK 2,500.-



HL-MUZZIE-3/PG 3,000.-



HL-BOSTON/3/B 8,500.-



HL-TRIZY 2,500.-



HL-BOSTON/3/A 9,000.-



HL-G0944/H3 1,800.-



Ceiling & Hanging



HL-83203-TROY1 2,800.-



HL-806/H3 2,000.-



HL-537/H3 2,000.-



HL-8253/H3 2,500.-



HL-1210/H3 3,200.-





HL-1220/H3 2,400.-



HL-1954/H3 3,000.-



HL-002/H3 1,500.-



HL-064/3/MP3 4,000.-



HL-120/H3 1,900.-



CR-MICHELL/16-85 28,000.-



HL-RINGKO/30/WWH-100 9,000.-



CH-QH-01/8 8,000.-



HL-4222/H3 2,000.-



HL-BM09/H3 2,200.-



HL-112/H3 2,500.-



HL-5567/H3 2,000.-



HL-CASPER/6/GL 15,000.-





HL-INSPIRE/10/GD 14,000.-



HL-BRANCH/6 6,000.-



Wall Light

เสน่ห์จากแสงไฟ สร้างสรรค์บรรยากาศบ้านสวย มีชีวิตชีวากับ
 มนต์เสน่ห์แสงไฟดวงเล็กที่ไม่ธรรมดา สิ่งที่สะท้อนความเป็นตัวตน
 หรือรสนิยมของความสุขในการใช้ชีวิต



WI-KRAM3 2,800.-



WI-KRAM2 2,500.-



WI-HOOK/A/BK 1,400.-



WI-HOOK/B/BK 1,600.-



WI-TOMSON/BK-36 1,400.-



WI-BOSTON/B/BK 1,200.-



WI-UTAH 1,200.-



WI-88193-PALERMO 1,500.-



WI-0020/1 500.-



WI-90647-FORTUNA 1,200.-





WI-198658 1,100.-



WI-179441 900.-



WI-6107 450.-



WI-6188 450.-



WI-602 600.-



WI-87221-PALMERA 1,300.-



WI-88563-HALVA 2,400.-



WI-89456-SANTANEDR 2,400.-



WI-90925-HALVA 3,000.-



WI-89816-ZEPTO 1,800.-



WI-91342-SANIA 1,000.-



WI-87219-PALMERA 1,600.-



WI-MBO185/1 940.-



WI-MBO184/1 940.-



WI-STELLA 900.-



WI-82218-EOS 2,000.-

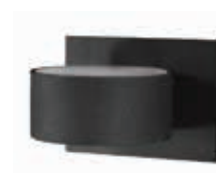

WI-1814-G9/BK 900.-



WI-1814-G9/SL 900.-





WI-83891-SINTAR 1,400.-



WI-0201 1,400.-



WI-CHILLI 840.-



WM-87139-CUBIK 2,400.-



WI-82219-EOS 2,050.-



WI-8067/2 1,700.-



WI-8037 900.-



WI-8061 1,200.-



WI-WL6-15/WH 1,400.-



WI-86996-NIKITA 1,200.-



WI-85338-MONO 1,000.-



WI-83405-ZOLA 2,150.-



WI-83406-ZOLA 1,500.-



WI-83407-ZOLA 950.-



WI-1866-T5-14 2,000.-





WI-APRIL 900.-



WI-TUBE30 1,200.-



WI-SWAN 900.-



WM-86541-BEVERLY 2,300.-



WI-AUGUST 1,200.-



WI-87019-MADRAS 1,200.-



WI-87018-MADRAS 1,000.-



WI-MIRROR 1,200.-



WI-KRAM7/WH 4,000.-



WI-9054 800.-



WI-9053 800.-



WI-91048/2 1,200.-



WI-579 960.-



WI-B-059 1,500.-



WI-975/1 600.-



WI-248/2 800.-



WI-573 800.-





WI-B-022 1,500.-



WI-B-032 1,500.-



WI-B-033 1,500.-



WI-220/1 800.-



WI-566 1,400.-



WI-3013/BL 1,000.-



WI-3013/RD 1,000.-



WI-62122 600.-



WI-62128 600.-



WI-62133 600.-



WI-634/OR 900.-



WI-634/YW 900.-



WI-814 900.-



WI-IN-B819RD+GN+YW 700.-



WI-IN-B819RD+YW+BK 700.-



WI-20064/2 800.-



WI-20087/1 600.-



WI-20087/2 800.-



WI-2037/1 600.-





CR-MILLER/12-65 30,000.-



Crystal Light

แสงไฟเพื่อบรรยากาศของบ้านสวย นอกเหนือจากความสำคัญ
ในเรื่องประโยชน์ใช้สอยแล้ว แสงไฟยังเป็นองค์ประกอบหนึ่งของการ
ตกแต่ง รูปแบบและดีไซน์ของไฟชนิดต่างๆ สร้างเสน่ห์ให้กับบ้าน



CR-2037/6 3,200.-



CR-20087/6+1 2,800.-



CR-8006/5 10,000.-



CR-8186/6 7,000.-



CR-2028/6 6,400.-



CR-2036/8+4 10,000.-



CR-8257/8+4/SL 10,000.-



CR-YH610/5 4,000.-





CR-8208-1P/SL 14,000.-



CR-YH814/6 9,000.-



CR-8012/5 9,000.-



CR-CF39/6 8,000.-



CR-9011/A 9,000.-



CL-8389/5+1 2,300.-



CL-6028/3 3,600.-



CL-5565/6 3,600.-



CL-PP006/6+1 1,800.-



CL-2696/6+1 1,800.-



CL-8150/3 2,000.-



CL-8888/5+1 2,200.-



CH-6004/5 2,200.-



CH-6211/5 1,700.-





CH-975/8+4 6,070.-



CH-9053/6+3 3,300.-



CH-6107/5 1,600.-



CL-2575/6+1 3,000.-



CH-2006/6+3 3,000.-



CH-5025/5+1 2,000.-



CL-9301/6 1,800.-



CL-8151/3 2,000.-



CH-35052D/5 2,800.-



CH-34389A/5 2,400.-



Table & Floor

เป็นโคมไฟที่ทำให้ประโยชน์ทั้งด้านฟังก์ชันและการตกแต่งเพื่อความสวยงามมากกว่าแค่ “แสงสว่าง” เพราะถ้าเลือกดี ๆ โคมไฟ จะกลายเป็น “ของตกแต่ง” ชั้นเยี่ยมในบ้านคุณ



FTT-NEWYORK/PG 2,000.-



FTT-NEWYORK/BK 1,200.-



FTT-NOOF/WH 880.-



FTT-NOOF/BK 880.-



FTT-NOOF/RD 880.-



FTT-LIPPO/WH 2,000.-



FTT-CITA/WH 2,500.-



FTT-REKER/BK 2,400.-

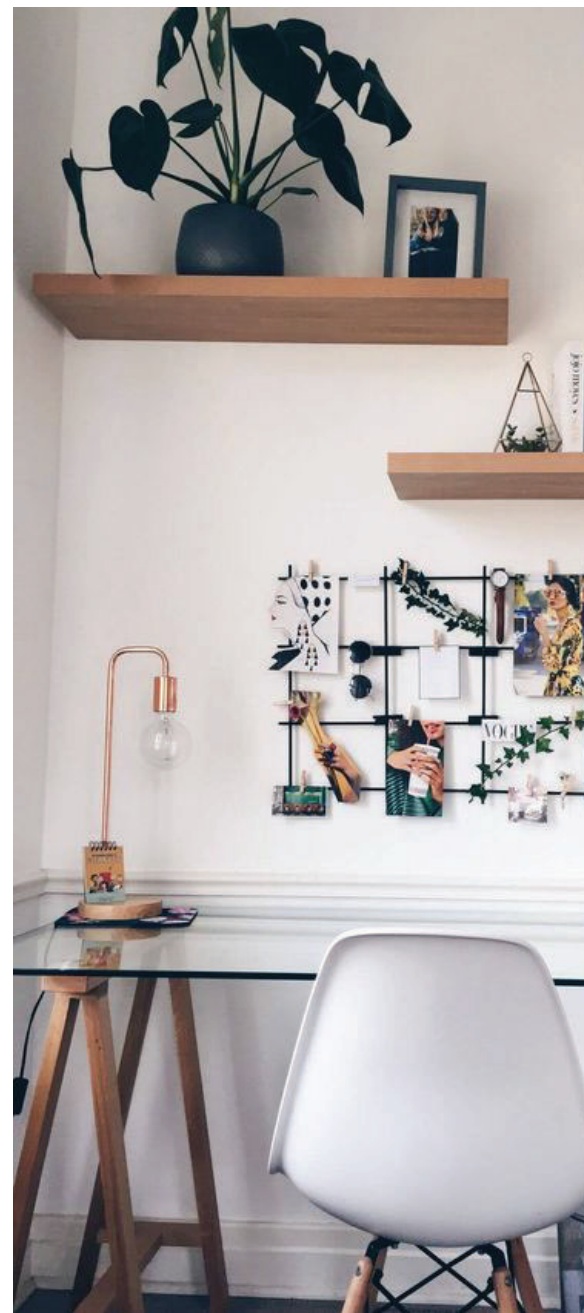



FTF-MIMOSA/WH 1,800.-



FTF-NOOF/WH 2,000.-



SCAN ME



WEBSITE

SCAN ME



LINE OFFICIAL

ITT I

บริษัท อิทธิฤทธิ์ ไนซ์ คอร์ปอเรชั่น จำกัด (มหาชน)

89/18-19 หมู่.5 ตำบลพันท้ายนรสิงห์ อำเภอเมืองสมุทรสาคร
จังหวัดสมุทรสาคร 74000

โทรศัพท์ : 034-870-577, 034-446-265, 034-446-267

Fax : 034-872-566

อีเมล : info@lighttrio.com