

SCAN ME



WEBSITE

SCAN ME



LINE OFFICIAL



OUTDOOR CLASSIC CATALOGUE 2023 - 2024



บริษัท อิทริทรี ไนซ์ คอร์ปอเรชั่น จำกัด (มหาชน)

89/18-19 หมู่.5 ตำบลพินท้ายบรสิงห์ อำเภอเมืองสมุทรสาคร จังหวัดสมุทรสาคร 74000

โทรศัพท์ : 034-870-577, 034-446-265, 034-446-267 Fax : 034-872-566

อีเมล : info@lighttrio.com

PRODUCT CONTENTS

產品目錄

01	歐式庭院燈系列 CLASSIC GARDEN LIGHT SERIES	001-153
02	歐式燈具系列 CLASSIC LIGHT FIXTURES SERIES	154-157
03	歐式燈臂系列 CLASSIC LIGHT ARM SERIES	158-159
04	歐式壁燈系列 CLASSIC WALL LIGHT SERIES	160-168
05	歐式柱頭燈系列 CLASSIC PILLAR LIGHT SERIES	169-173



RHS-15404

產品特點:

- 燈體材質: 優質鋁製品, 經防腐處理后, 采用防UV靜電粉未噴塗;
- 透光罩: PC透明燈罩;
- 緊固件: 不銹鋼材質, 强度高, 防腐蝕能力強;
- 適用光源: 節能燈/LED 35-45W
- 顏色: 深灰色

PRODUCTS CHARACTERS:

- Body: Made of high quality cast aluminum and iron alloy with treatment of corrosion protection and UV-proof powder coating.
- Diffuser: Clear polycarbonate.
- Fastener: Made of stainless steel with high intensity and corrosion protection.
- Lamp: Energy-saving lamp/LED 35W-45W
- Finish: Red bronze as standard. Matt coffee, matt black, dark grey, matt grey any other RAL color is available upon request.

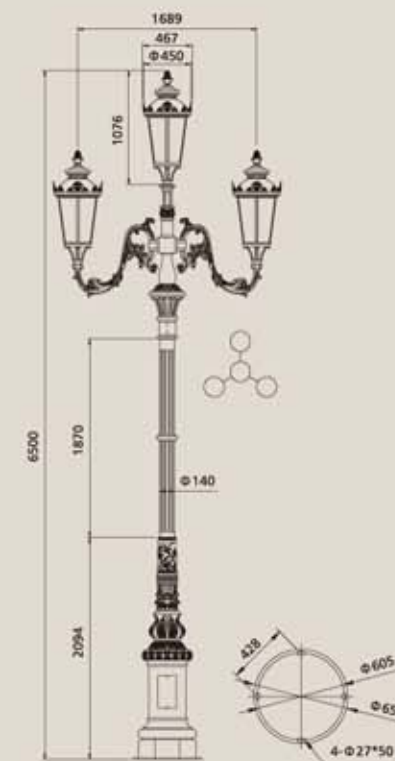

產品特點:

- 燈體材質: 優質鋁製品, 經防腐處理后, 采用防UV靜電粉末噴塗;
- 透光罩: PC奶白燈罩;
- 緊固件: 不鏽鋼材質, 强度高, 防腐蝕能力強;
- 適用光源: 金鹵燈/鈉燈70-150W/節能燈65-85W/LED
- 顏色: 沙黑色

PRODUCTS CHARACTERS:

- Body: Made of high quality cast aluminum and iron alloy with treatment of corrosion protection and UV-proof powder coating.
- Diffuser: Opal polycarbonate.
- Fastener: Made of stainless steel with high intensity and corrosion protection.
- Lamp: Metal halide lamp/Sodium lamp 70-150W/Energy-saving lamp 65-85W/LED
- Finish: Matt black as standard. Matt coffee, dark grey, dark bronze, matt grey any other RAL color is available upon request.



RHS-15412

產品特點:

- 燈體材質: 優質鋁製品, 經防腐處理后, 采用防UV靜電粉末噴塗;
- 透光罩: PC奶白燈罩;
- 緊固件: 不鏽鋼材質, 强度高, 防腐蝕能力強;
- 適用光源: 金鹵燈/鈉燈70-150W/LED 65-85W
- 顏色: 沙黑色

PRODUCTS CHARACTERS:

- Body: Made of high quality cast aluminum and iron alloy with treatment of corrosion protection and UV-proof powder coating.
- Diffuser: Opal polycarbonate.
- Fastener: Made of stainless steel with high intensity and corrosion protection.
- Lamp: Metal halide lamp/Sodium lamp 70-150W/LED 65-85W
- Finish: Matt black as standard. Matt coffee, dark grey, dark bronze, matt grey any other RAL color is available upon request.

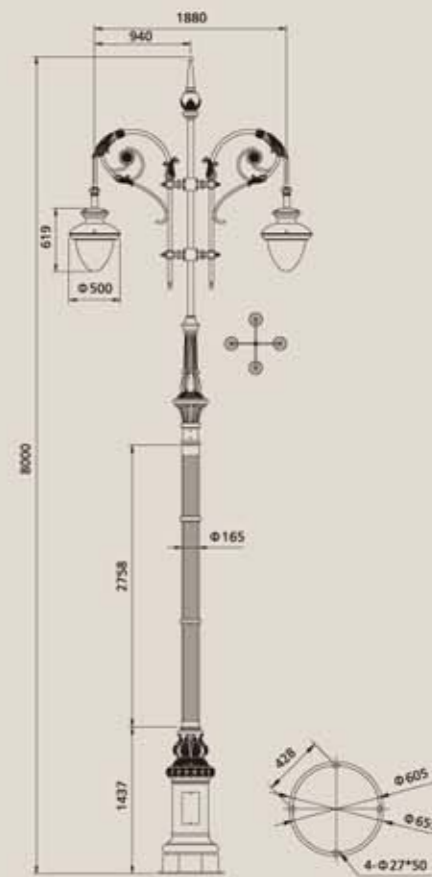

RHS-15407

產品特點:

- 燈體材質: 優質鋁製品, 經防腐處理后, 采用防UV靜電粉末噴塗;
- 透光罩: PC磨砂燈罩;
- 緊固件: 不鏽鋼材質, 强度高, 防腐蝕能力強;
- 適用光源: 金鹵燈/鈉燈70-150W/LED 65-85W
- 顏色: 沙黑色

PRODUCTS CHARACTERS:

- Body: Made of high quality cast aluminum and iron alloy with treatment of corrosion protection and UV-proof powder coating.
- Diffuser: Frosted polycarbonate.
- Fastener: Made of stainless steel with high intensity and corrosion protection.
- Lamp: Metal halide lamp/Sodium lamp 70-150W/LED 65-85W
- Finish: Matt black as standard. Matt coffee, dark grey, dark bronze, matt grey any other RAL color is available upon request.

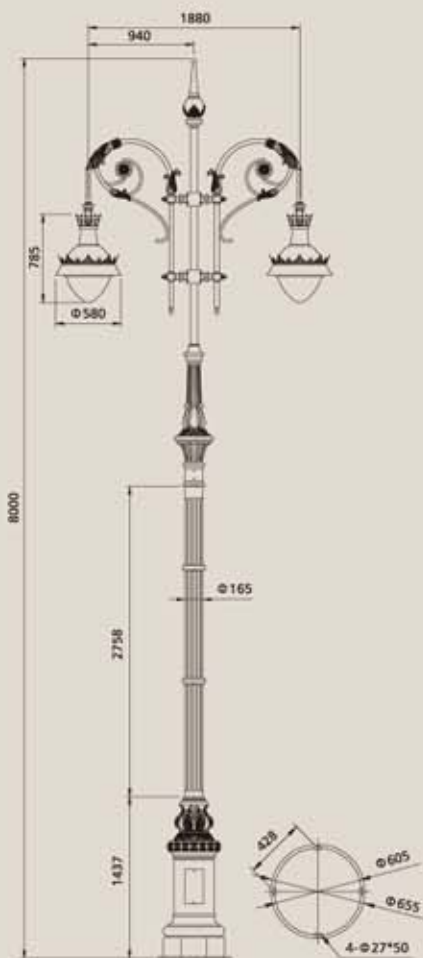

RHS-15408

產品特點:

- 燈體材質: 優質鋁製品, 經防腐處理后, 采用防UV靜電粉末噴塗;
- 透光罩: PC磨砂燈罩;
- 緊固件: 不鏽鋼材質, 强度高, 防腐蝕能力強;
- 適用光源: LED 36-45W
- 顏色: 紅古銅色+金色

PRODUCTS CHARACTERS:

- Body: Made of high quality cast aluminum and iron alloy with treatment of corrosion protection and UV-proof powder coating.
- Diffuser: Frosted polycarbonate.
- Fastener: Made of stainless steel with high intensity and corrosion protection.
- Lamp: LED 36-45W
- Finish: Red bronze as standard. Matt coffee, matt black, dark grey, matt grey any other RAL color is available upon request.

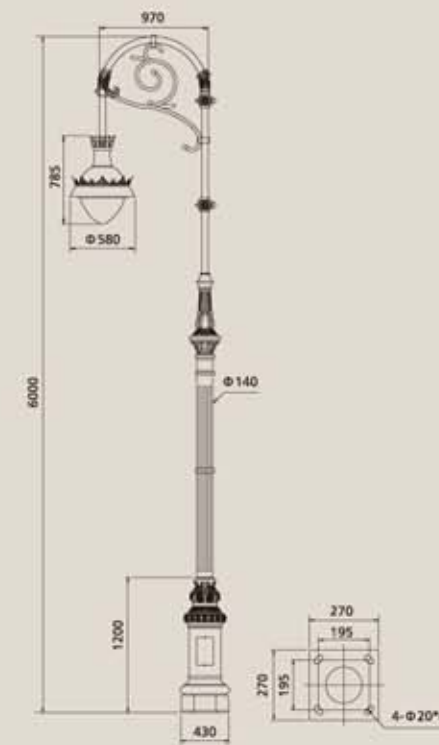

RHS-14332

產品特點:

- 燈體材質: 燈具鋁製品燈杆鐵制熱鍍鋅, 經防腐處理后, 采用防UV靜電粉末噴塗;
- 透光罩: PC燈罩;
- 緊固件: 不鏽鋼材質, 强度高, 防腐蝕能力強;
- 適用光源: 節能燈36-45W/金鹵燈/鈉燈 150-250W
- 顏色: 黑色+金色

PRODUCTS CHARACTERS:

- Body: Luminarie is made of high quality cast aluminum, light pole is made of hot-dip galvanized iron.
- Diffuser: Polycarbonate.
- Fastener: Made of stainless steel with high intensity and corrosion protection.
- Lamp: Energy-saving lamp 36-45W/Metal halide lamp/sodium lamp 150-250W
- Finish: Red bronze as standard.Matt coffee,matt black, dark grey, matt grey any other RAL color is available upon request.

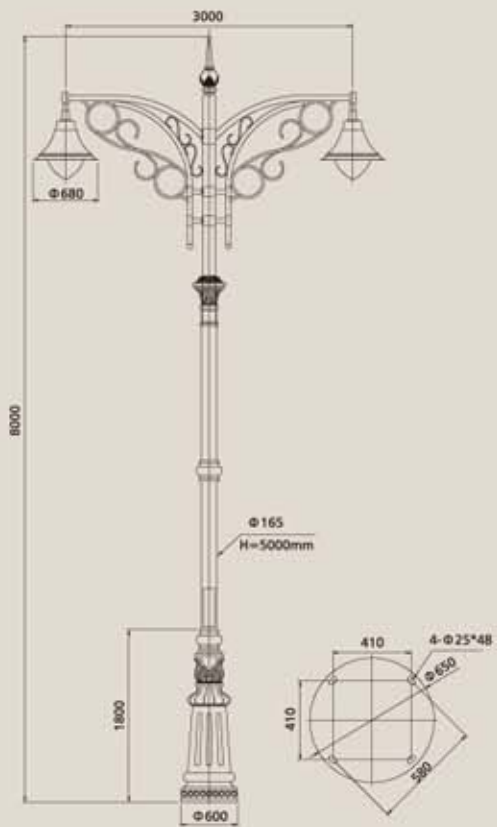

RHS-17379

產品特點:

- 燈體材質: 優質鋁製品, 經防腐處理后, 采用防UV靜電粉末噴塗;
- 透光罩: PC奶白燈罩;
- 緊固件: 不鏽鋼材質, 强度高, 防腐蝕能力強;
- 適用光源: 金鹵燈/鈉燈70-150W/LED 45-85W
- 顏色: 古銅色

PRODUCTS CHARACTERS:

- Body: Made of high quality cast aluminum and iron alloy with treatment of corrosion protection and UV-proof powder coating
- Diffuser: Opal polycarbonate
- Fastener: Made of stainless steel with high intensity and corrosion protection
- Lamp: Metal halide lamp/Sodium lamp 70-150W/LED 45-85W
- Finish: Matt red as standard.Dark grey,Matt grey, Dark bronze, Matt coffee, Matt black any other RAL color is available upon request.



RHS-17378

產品特點:

- 燈體材質: 優質鋁合金鑄造成型, 經防腐處理后, 采用防UV靜電粉末噴塗;
- 透光罩: PC/奶白燈罩;
- 緊固件: 不鏽鋼材質, 强度高, 防腐蝕能力強;
- 適用光源: LED 24-36W
- 顏色: 深灰色

PRODUCTS CHARACTERS:

- Body: Made of high quality cast aluminum alloy with treatment of corrosion protection and UV-proof powder coating.
- Diffuser: Opal polycarbonate.
- Fastener: Made of stainless steel with high intensity and corrosion protection.
- Lamp: LED 24-36W
- Finish: Dark grey as standard. Matt coffee, matt black, dark bronze, matt grey any other RAL color is available upon request.

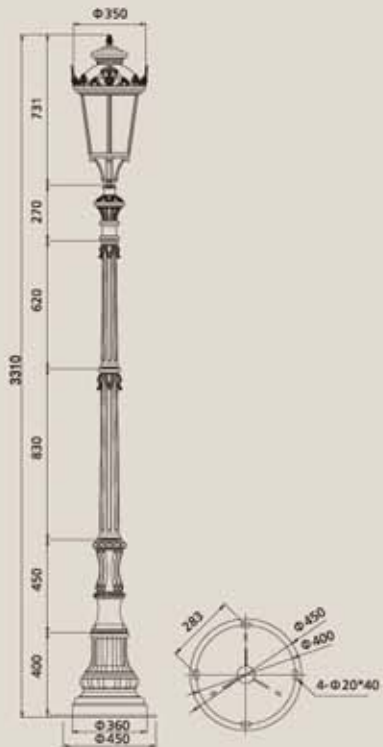

RHS-17301

產品特點:

- 燈體材質: 優質鋁合金鑄造成型, 經防腐處理后, 采用防UV靜電粉末噴塗;
- 透光罩: 磨砂玻璃燈罩;
- 緊固件: 不鏽鋼材質, 强度高, 防腐蝕能力強;
- 適用光源: LED 24-36W
- 顏色: 沙銀色

PRODUCTS CHARACTERS:

- Body: Made of high quality cast aluminum alloy with treatment of corrosion protection and UV-proof powder coating.
- Diffuser: Frosted glass.
- Fastener: Made of stainless steel with high intensity and corrosion protection.
- Lamp: LED 24-36W
- Finish: Dark grey as standard. Matt coffee, matt black, dark bronze, matt grey any other RAL color is available upon request.

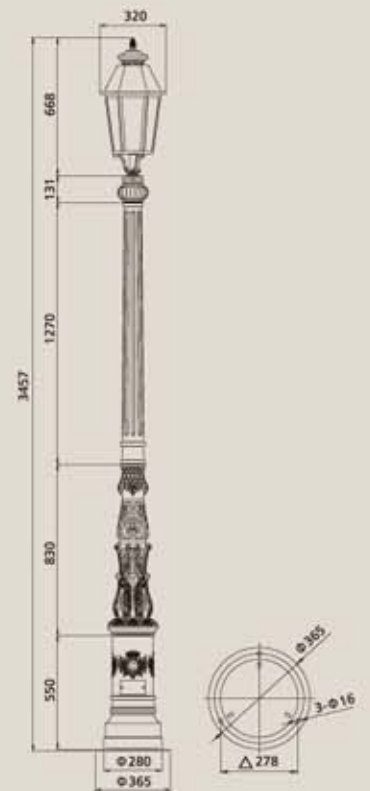

RHS-17302

產品特點:

- 燈體材質: 優質鋁合金鑄造成型, 經防腐處理后, 采用防UV靜電粉末噴塗;
- 透光罩: PC奶白燈罩;
- 緊固件: 不鏽鋼材質, 强度高, 防腐蝕能力強;
- 適用光源: LED 24-36W
- 顏色: 深灰色/沙黑色

PRODUCTS CHARACTERS:

- Body: Made of high quality cast aluminum alloy with treatment of corrosion protection and UV-proof powder coating.
- Diffuser: Opal polycarbonate.
- Fastener: Made of stainless steel with high intensity and corrosion protection.
- Lamp: LED 24-36W
- Finish: Dark grey as standard. Matt coffee, matt black, dark bronze, matt grey any other RAL color is available upon request.



RHS-17303



RHS-17304



RHS-17305



RHS-17306

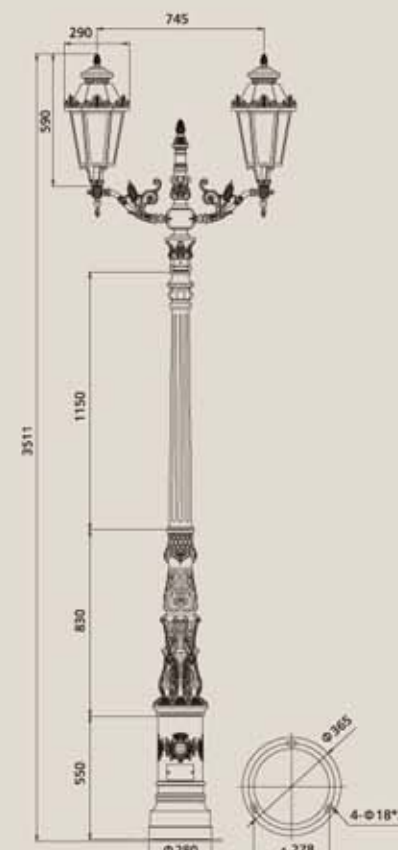

產品特點:

- 燈體材質: 優質鋁合金鑄造成型, 經防腐處理后, 采用防UV靜電粉末噴塗;
- 透光罩: PC奶白燈罩/磨砂玻璃燈罩;
- 緊固件: 不鏽鋼材質, 强度高, 防腐蝕能力強;
- 適用光源: LED 12-30W
- 顏色: 沙銀色/沙黑色

PRODUCTS CHARACTERS:

- Body: Made of high quality cast aluminum alloy with treatment of corrosion protection and UV-proof powder coating.
- Diffuser: Frosted glass.
- Fastener: Made of stainless steel with high intensity and corrosion protection.
- Lamp: LED 12-30W
- Finish: Dark grey as standard. Matt coffee, matt black, dark bronze, matt grey any other RAL color is available upon request.

產品特點:

- 燈體材質: 優質鋁合金鑄造成型, 經防腐處理后, 采用防UV靜電粉末噴塗;
- 透光罩: PC奶白燈罩;
- 緊固件: 不鏽鋼材質, 强度高, 防腐蝕能力強;
- 適用光源: LED 24-36W
- 顏色: 深灰色

PRODUCTS CHARACTERS:

- Body: Made of high quality cast aluminum alloy with treatment of corrosion protection and UV-proof powder coating.
- Diffuser: Opal polycarbonate.
- Fastener: Made of stainless steel with high intensity and corrosion protection.
- Lamp: LED 24-36W
- Finish: Dark grey as standard. Matt coffee, matt black, dark bronze, matt grey any other RAL color is available upon request.

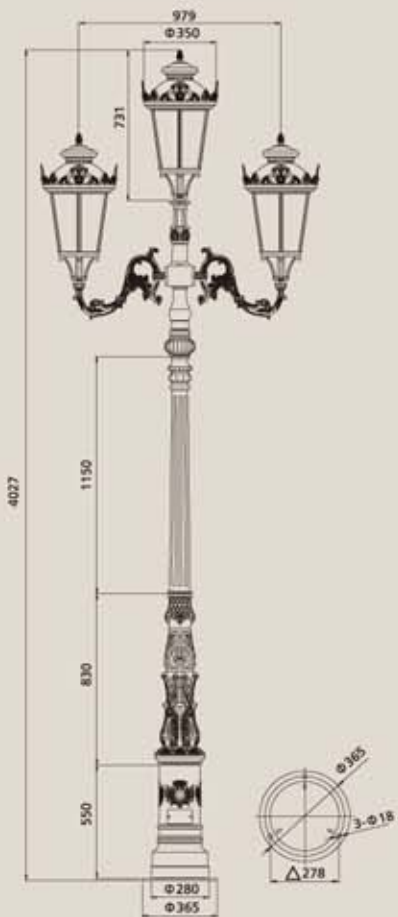

RHS-17307



RHS-17308

產品特點:

- 燈體材質: 優質鋁合金鑄造成型, 經防腐處理后, 采用防UV靜電粉末噴塗;
- 透光罩: PC奶白燈罩;
- 緊固件: 不鏽鋼材質, 强度高, 防腐蝕能力強;
- 適用光源: LED 15-24W
- 顏色: 沙黑色

PRODUCTS CHARACTERS:

- Body: Made of high quality cast aluminum alloy with treatment of corrosion protection and UV-proof powder coating.
- Diffuser: Opal polycarbonate.
- Fastener: Made of stainless steel with high intensity and corrosion protection.
- Lamp: LED 15-24W
- Finish: Dark grey as standard. Matt coffee, matt black, dark bronze, matt grey any other RAL color is available upon request.

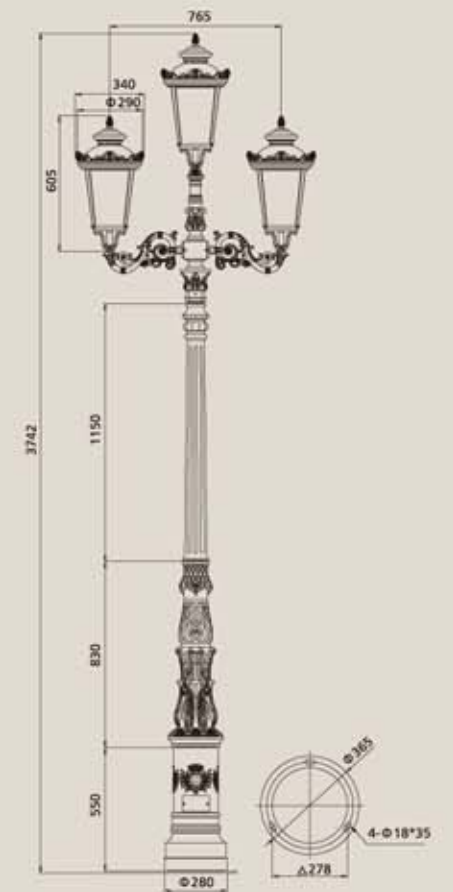

產品特點:

- 燈體材質: 優質鋁合金鑄造成型, 經防腐處理后, 采用防UV靜電粉末噴塗;
- 透光罩: 磨砂玻璃燈罩/奶白塑料燈罩;
- 緊固件: 不鏽鋼材質, 强度高, 防腐蝕能力強;
- 適用光源: LED 24-36W
- 顏色: 沙銀色/深灰色

PRODUCTS CHARACTERS:

- Body: Made of high quality cast aluminum alloy with treatment of corrosion protection and UV-proof powder coating.
- Diffuser: Frosted glass/Opal plastic.
- Fastener: Made of stainless steel with high intensity and corrosion protection.
- Lamp: LED 24-36W
- Finish: Dark grey as standard. Matt coffee, matt black, dark bronze, matt grey any other RAL color is available upon request.

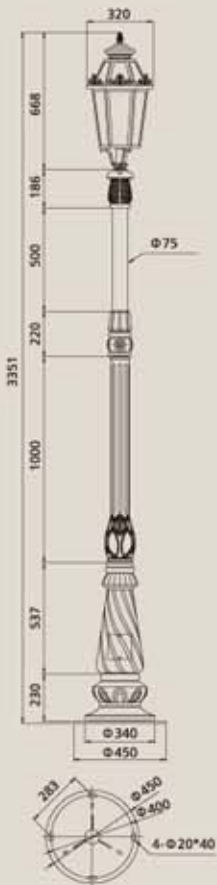

RHS-17309

RHS-17310



RHS-17311

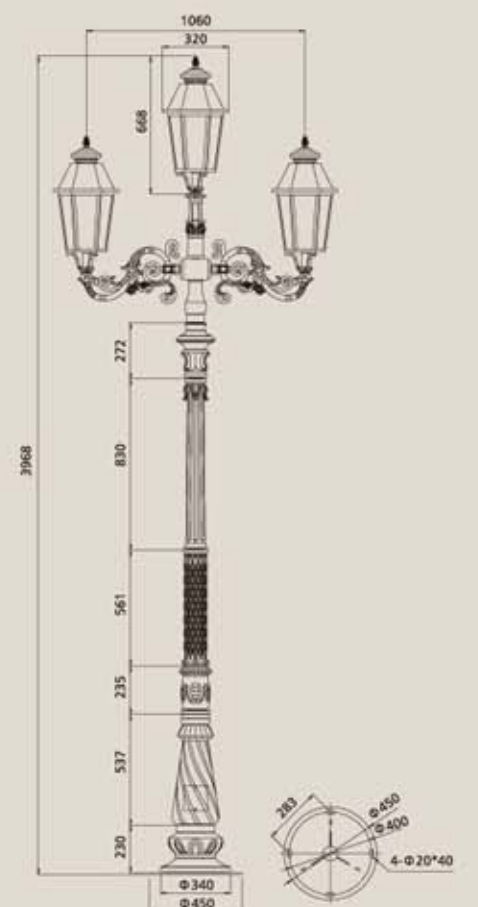

產品特點:

- 燈體材質: 優質鋁合金鑄造成型, 經防腐處理后, 采用防UV靜電粉末噴塗;
- 透光罩: 磨砂玻璃燈罩;
- 緊固件: 不鏽鋼材質, 强度高, 防腐蝕能力強;
- 適用光源: LED 24-36W
- 顏色: 咖啡色

PRODUCTS CHARACTERS:

- Body: Made of high quality cast aluminum alloy with treatment of corrosion protection and UV-proof powder coating.
- Diffuser: Frosted glass.
- Fastener: Made of stainless steel with high intensity and corrosion protection.
- Lamp: LED 24-36W
- Finish: Dark grey as standard. Matt coffee, matt black, dark bronze, matt grey any other RAL color is available upon request.

產品特點:

- 燈體材質: 優質鋁合金鑄造成型, 經防腐處理后, 采用防UV靜電粉末噴塗;
- 透光罩: PC奶白燈罩;
- 緊固件: 不鏽鋼材質, 强度高, 防腐蝕能力強;
- 適用光源: LED 15-36W
- 顏色: 沙銀色/沙黑色

PRODUCTS CHARACTERS:

- Body: Made of high quality cast aluminum alloy with treatment of corrosion protection and UV-proof powder coating.
- Diffuser: Opal polycarbonate.
- Fastener: Made of stainless steel with high intensity and corrosion protection.
- Lamp: LED 15-36W
- Finish: Dark grey as standard. Matt coffee, matt black, dark bronze, matt grey any other RAL color is available upon request.

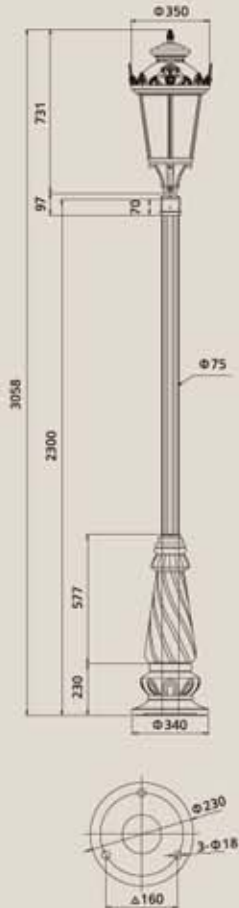

RHS-17312



RHS-17313

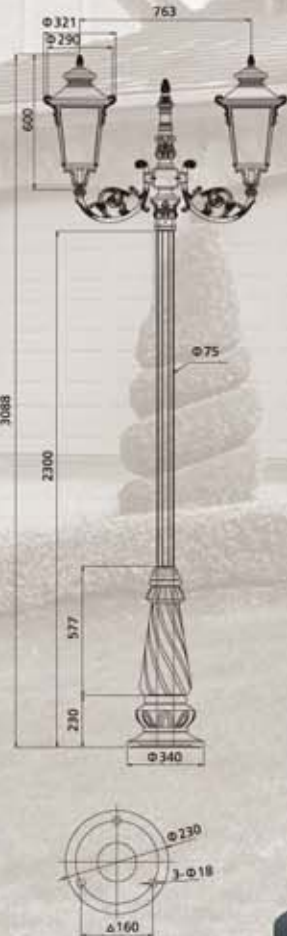

RHS-17314

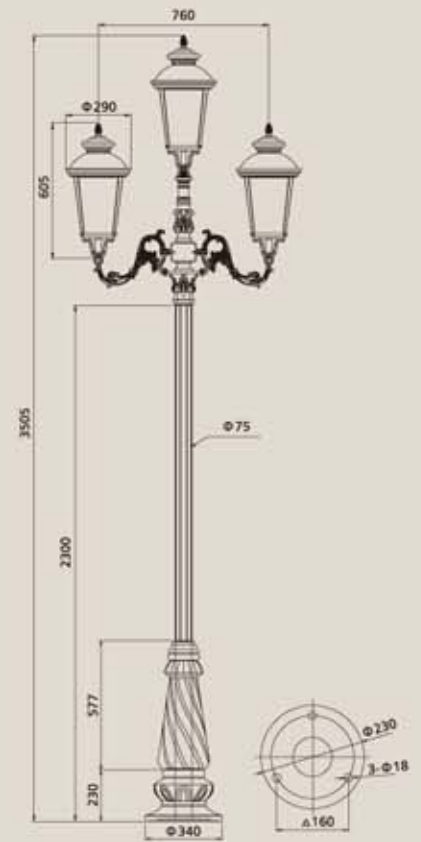

產品特點:

- 燈體材質: 優質鋁合金鑄造成型, 經防腐處理后, 采用防UV靜電粉末噴塗;
- 透光罩: PC奶白燈罩;
- 緊固件: 不鏽鋼材質, 强度高, 防腐蝕能力強;
- 適用光源: LED 15-24W
- 顏色: 沙黑色

PRODUCTS CHARACTERS:

- Body: Made of high quality cast aluminum alloy with treatment of corrosion protection and UV-proof powder coating.
- Diffuser: Opal polycarbonate.
- Fastener: Made of stainless steel with high intensity and corrosion protection.
- Lamp: LED 15-24W
- Finish: Dark grey as standard. Matt coffee, matt black, dark bronze, matt grey any other RAL color is available upon request.

產品特點:

- 燈體材質: 優質鋁合金鑄造成型, 經防腐處理后, 采用防UV靜電粉末噴塗;
- 透光罩: 磨砂玻璃燈罩/奶白塑料燈罩;
- 緊固件: 不鏽鋼材質, 强度高, 防腐蝕能力強;
- 適用光源: LED 24-36W
- 顏色: 深灰色/沙銀色

PRODUCTS CHARACTERS:

- Body: Made of high quality cast aluminum alloy with treatment of corrosion protection and UV-proof powder coating
- Diffuser: Frosted glass/Opal plastic
- Fastener: Made of stainless steel with high intensity and corrosion protection
- Lamp: LED 24-36W
- Finish: Matt black as standard. Dark grey, Matt coffee, Matt grey, Dark bronze any other RAL color is available upon request.

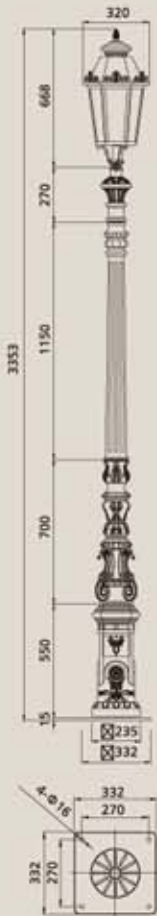

RHS-17315



RHS-17316

產品特點:

- 燈體材質: 優質鋁合金鑄造成型, 經防腐處理后, 采用防UV靜電粉末噴塗;
- 透光罩: PC奶白燈罩;
- 緊固件: 不鏽鋼材質, 强度高, 防腐蝕能力強;
- 適用光源: LED 24-36W
- 顏色: 深灰色

PRODUCTS CHARACTERS:

- Body: Made of high quality cast aluminum alloy with treatment of corrosion protection and UV-proof powder coating
- Diffuser: Opal polycarbonate
- Fastener: Made of stainless steel with high intensity and corrosion protection
- Lamp: LED 24-36W
- Finish: Matt black as standard. Dark grey, Matt coffee, Matt grey, Dark bronze any other RAL color is available upon request.



RHS-17317

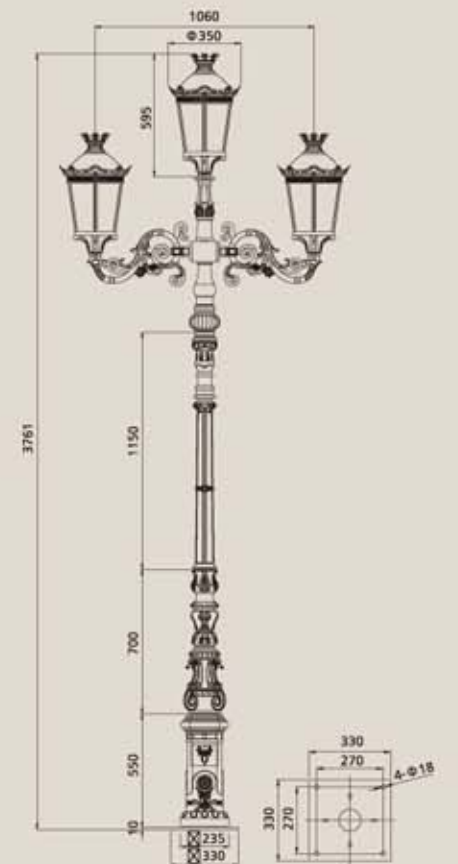

產品特點:

- 燈體材質: 優質鋁合金鑄造成型, 經防腐處理后, 采用防UV靜電粉末噴塗;
- 透光罩: PC奶白燈罩;
- 緊固件: 不鏽鋼材質, 强度高, 防腐蝕能力強;
- 適用光源: LED 15-36W
- 顏色: 沙黑色/深灰色

PRODUCTS CHARACTERS:

- Body: Made of high quality cast aluminum alloy with treatment of corrosion protection and UV-proof powder coating
- Diffuser: Opal polycarbonate
- Fastener: Made of stainless steel with high intensity and corrosion protection
- Lamp: LED 15-36W
- Finish: Matt black as standard. Dark grey, Matt coffee, Matt grey, Dark bronze any other RAL color is available upon request.



RHS-17318

RHS-17319

產品特點:

- 燈體材質: 優質鋁合金鑄造成型, 經防腐處理后, 采用防UV靜電粉末噴塗;
- 透光罩: PC奶白燈罩;
- 緊固件: 不鏽鋼材質, 强度高, 防腐蝕能力強;
- 適用光源: LED 15-24W
- 顏色: 沙銀色

PRODUCTS CHARACTERS:

- Body: Made of high quality cast aluminum alloy with treatment of corrosion protection and UV-proof powder coating
- Diffuser: Opal polycarbonate
- Fastener: Made of stainless steel with high intensity and corrosion protection
- Lamp: LED 15-24W
- Finish: Matt black as standard. Dark grey, Matt coffee, Matt grey, Dark bronze any other RAL color is available upon request.



RHS-17320

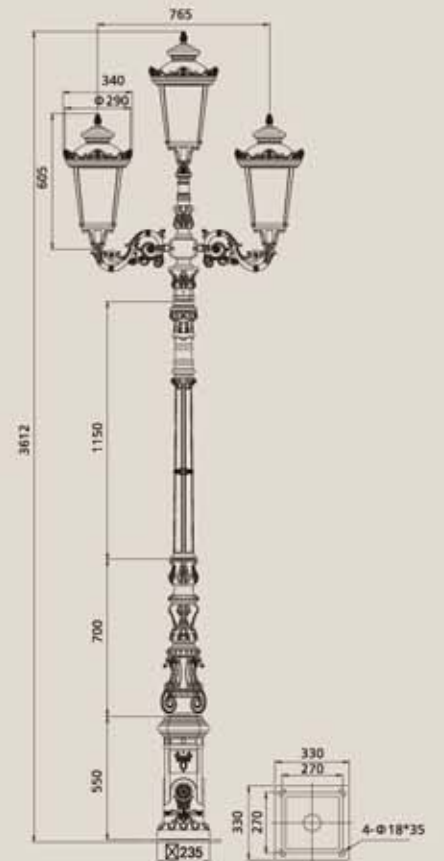

產品特點:

- 燈體材質: 優質鋁合金鑄造型, 經防腐處理后, 采用防UV靜電粉末噴塗;
- 透光罩: PC奶白燈罩;
- 緊固件: 不鏽鋼材質, 强度高, 防腐蝕能力強;
- 適用光源: LED 36-45W
- 顏色: 深灰色

PRODUCTS CHARACTERS:

- Body: Made of high quality cast aluminum alloy with treatment of corrosion protection and UV-proof powder coating
- Diffuser: Opal polycarbonate
- Fastener: Made of stainless steel with high intensity and corrosion protection
- Lamp: LED 36-45W
- Finish: Dark grey as standard. Matt coffee, Matt grey, Dark bronze, Matt black any other RAL color is available upon request.

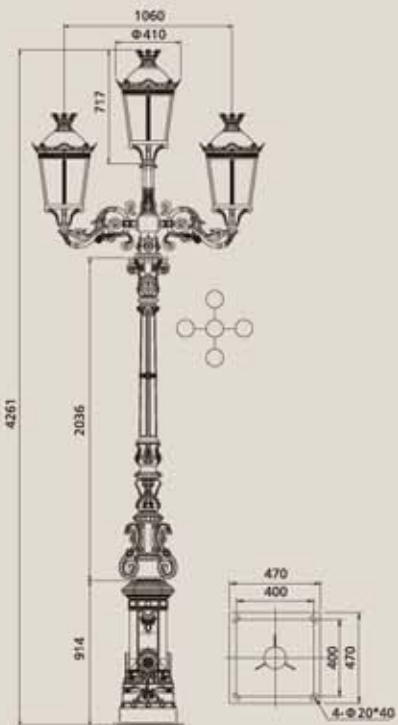

RHS-16387

產品特點:

- 燈體材質: 優質鋁合金鑄造型, 經防腐處理后, 采用防UV靜電粉末噴塗;
- 透光罩: PC奶白燈罩;
- 緊固件: 不鏽鋼材質, 强度高, 防腐蝕能力強;
- 適用光源: LED 36-45W
- 顏色: 沙黑色

PRODUCTS CHARACTERS:

- Body: Made of high quality cast aluminum alloy with treatment of corrosion protection and UV-proof powder coating
- Diffuser: Opal polycarbonate
- Fastener: Made of stainless steel with high intensity and corrosion protection
- Lamp: LED 36-45W
- Finish: Matt black as standard. Dark grey, Matt grey, Dark bronze, Matt coffee any other RAL color is available upon request.

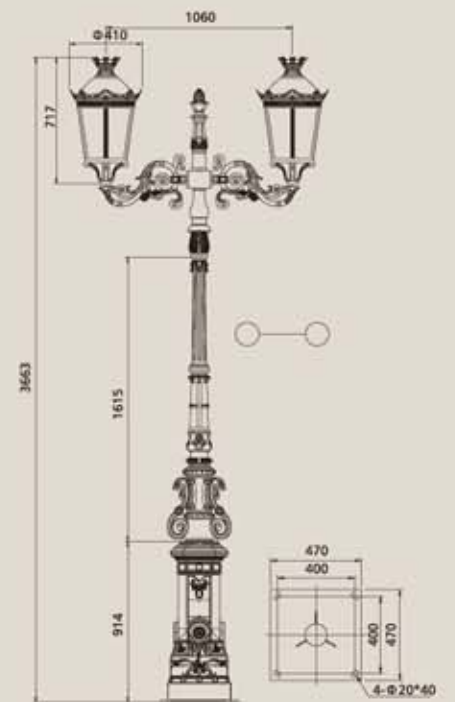

RHS-16385

產品特點:

- 燈體材質: 優質鋁合金鑄造成型, 經防腐處理后, 采用防UV靜電粉末噴塗;
- 透光罩: PC奶白燈罩;
- 緊固件: 不鏽鋼材質, 强度高, 防腐蝕能力強;
- 適用光源: LED 36-45W
- 顏色: 沙黑色/沙銀色

PRODUCTS CHARACTERS:

- Body: Made of high quality cast aluminum alloy with treatment of corrosion protection and UV-proof powder coating
- Diffuser: Opal polycarbonate
- Fastener: Made of stainless steel with high intensity and corrosion protection
- Lamp: LED 36-45W
- Finish: Matt black as standard. Dark grey, Matt grey, Dark bronze, Matt coffee any other RAL color is available upon request.



RHS-16389



RHS-16393



RHS-16399

產品特點:

- 燈體材質: 優質鋁合金鑄造成型, 經防腐處理后, 采用防UV靜電粉末噴塗;
- 透光罩: PC奶白燈罩;
- 緊固件: 不鏽鋼材質, 强度高, 防腐蝕能力強;
- 適用光源: LED 24-36W
- 顏色: 深灰色

PRODUCTS CHARACTERS:

- Body: Made of high quality cast aluminum alloy with treatment of corrosion protection and UV-proof powder coating
- Diffuser: Opal polycarbonate
- Fastener: Made of stainless steel with high intensity and corrosion protection
- Lamp: LED 24-36W
- Finish: Dark grey as standard. Matt coffee, Matt grey, Dark bronze, Matt black any other RAL color is available upon request.

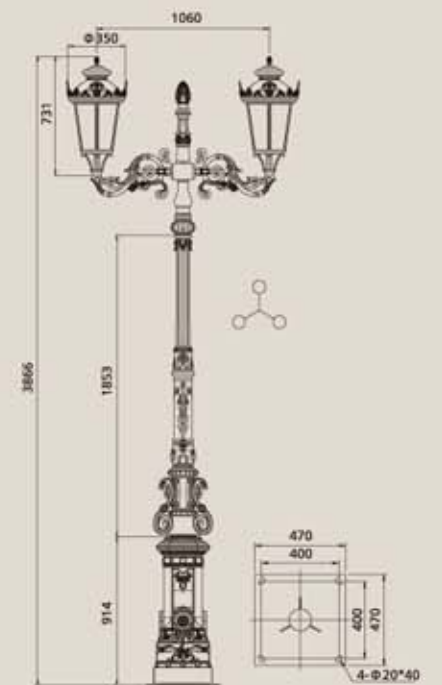

產品特點:

- 燈體材質: 優質鋁合金鑄造成型, 經防腐處理后, 采用防UV靜電粉末噴塗;
- 透光罩: PC奶白燈罩/奶白塑料燈罩;
- 緊固件: 不鏽鋼材質, 強度高, 防腐蝕能力強;
- 適用光源: LED 15-24W
- 顏色: 沙銀色/深灰色

PRODUCTS CHARACTERS:

- Body: Made of high quality cast aluminum alloy with treatment of corrosion protection and UV-proof powder coating.
- Diffuser: Opal polycarbonate/Opal plastic.
- Fastener: Made of stainless steel with high intensity and corrosion protection.
- Lamp: LED 15-24W
- Finish: Matt black as standard. Matt coffee, dark grey, dark bronze, matt grey any other RAL color is available upon request.

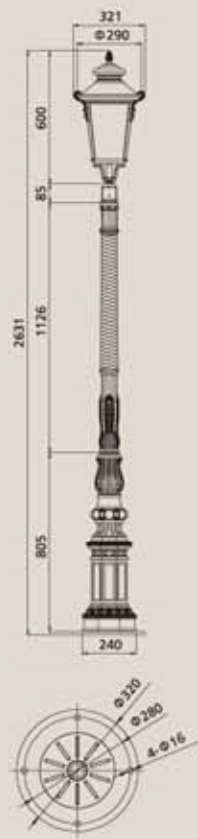

RHS-17321



RHS-14023

產品特點:

- 燈體材質: 優質鋁合金鑄造成型, 經防腐處理后, 采用防UV靜電粉末噴塗;
- 透光罩: PC奶白燈罩;
- 緊固件: 不鏽鋼材質, 強度高, 防腐蝕能力強;
- 適用光源: LED 24-36W
- 顏色: 深灰色/沙銀色

PRODUCTS CHARACTERS:

- Body: Made of high quality cast aluminum alloy with treatment of corrosion protection and UV-proof powder coating.
- Diffuser: Opal polycarbonate.
- Fastener: Made of stainless steel with high intensity and corrosion protection.
- Lamp: LED 24-36W
- Finish: Matt black as standard. Matt coffee, dark grey, dark bronze, matt grey any other RAL color is available upon request.



RHS-16459



RHS-16467

產品特點:

- 燈體材質: 優質鋁合金鑄造成型, 經防腐處理后, 采用防UV靜電粉末噴塗;
- 透光罩: PC奶白燈罩;
- 緊固件: 不鏽鋼材質, 强度高, 防腐蝕能力強;
- 適用光源: LED 24-36W
- 顏色: 深灰色

PRODUCTS CHARACTERS:

- Body: Made of high quality cast aluminum alloy with treatment of corrosion protection and UV-proof powder coating
- Diffuser: Opal polycarbonate
- Fastener: Made of stainless steel with high intensity and corrosion protection
- Lamp: LED 24-36W
- Finish: Dark grey as standard. Matt coffee, Matt grey, Dark bronze, Matt black any other RAL color is available upon request.

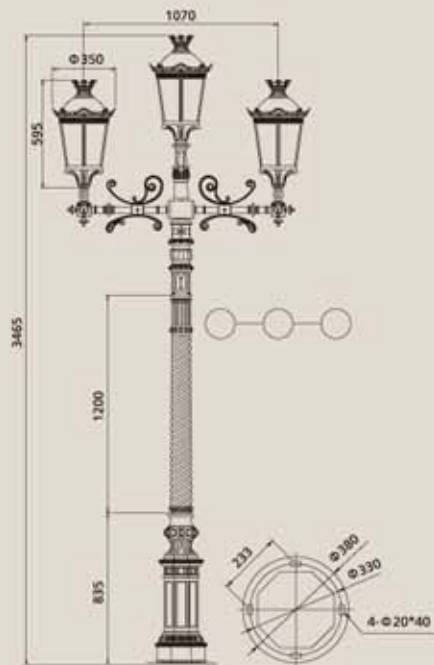

RHS-16465

產品特點:

- 燈體材質: 優質鋁合金鑄造成型, 經防腐處理后, 采用防UV靜電粉末噴塗;
- 透光罩: 磨砂玻璃燈罩;
- 緊固件: 不鏽鋼材質, 强度高, 防腐蝕能力強;
- 適用光源: LED 15-24W
- 顏色: 沙黃色/深灰色

PRODUCTS CHARACTERS:

- Body: Made of high quality cast aluminum alloy with treatment of corrosion protection and UV-proof powder coating.
- Diffuser: Frosted glass.
- Fastener: Made of stainless steel with high intensity and corrosion protection.
- Lamp: LED 15-24W
- Finish: Dark grey as standard. Matt coffee, matt black, dark bronze, matt grey any other RAL color is available upon request.



RHS-17322

RHS-17323



產品特點:

- 燈體材質: 優質鋁合金鑄造成型, 經防腐處理后, 采用防UV靜電粉末噴塗;
- 透光罩: PC奶白燈罩;
- 緊固件: 不鏽鋼材質, 强度高, 防腐蝕能力強;
- 適用光源: LED 15-24W
- 顏色: 沙銀色

PRODUCTS CHARACTERS:

- Body: Made of high quality cast aluminum alloy with treatment of corrosion protection and UV-proof powder coating
- Diffuser: Opal polycarbonate
- Fastener: Made of stainless steel with high intensity and corrosion protection
- Lamp: LED 15-24W
- Finish: Dark grey as standard. Matt coffee, Matt grey, Dark bronze, Matt black any other RAL color is available upon request.

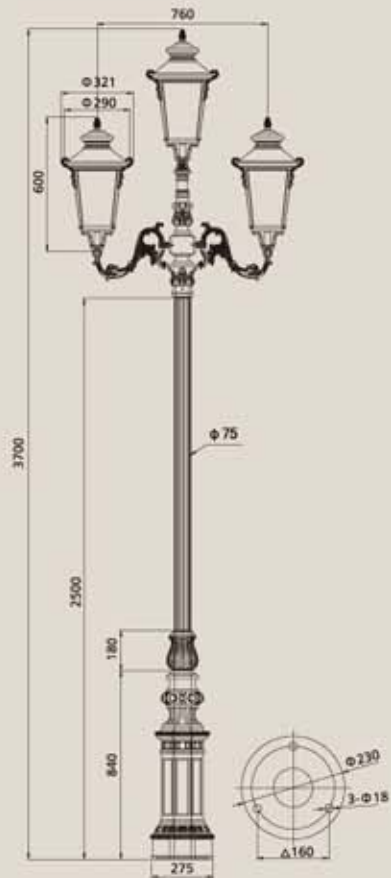

RHS-17324

產品特點:

- 燈體材質: 優質鋁合金鑄造成型, 經防腐處理后, 采用防UV靜電粉末噴塗;
- 透光罩: PC奶白燈罩;
- 緊固件: 不鏽鋼材質, 强度高, 防腐蝕能力強;
- 適用光源: LED 36-45W
- 顏色: 古銅色/深灰色

PRODUCTS CHARACTERS:

- Body: Made of high quality cast aluminum alloy with treatment of corrosion protection and UV-proof powder coating.
- Diffuser: Opal polycarbonate.
- Fastener: Made of stainless steel with high intensity and corrosion protection.
- Lamp: LED 36-45W
- Finish: Dark grey as standard. Matt coffee, matt black, dark bronze, matt grey any other RAL color is available upon request.



RHS-15527

RHS-15529

產品特點:

- 燈體材質: 優質鋁合金鑄造成型, 經防腐處理后, 采用防UV靜電粉末噴塗;
- 透光罩: 磨砂玻璃燈罩/PC透明燈罩;
- 緊固件: 不鏽鋼材質, 强度高, 防腐蝕能力強;
- 適用光源: LED 36-45W
- 顏色: 咖啡色/沙銀色

PRODUCTS CHARACTERS:

- Body: Made of high quality cast aluminum alloy with treatment of corrosion protection and UV-proof powder coating.
- Diffuser: Frosted glass/Clear polycarbonate.
- Fastener: Made of stainless steel with high intensity and corrosion protection.
- Lamp: LED 36-45W
- Finish: Matt black as standard. Matt coffee, dark grey, dark bronze, matt grey any other RAL color is available upon request.

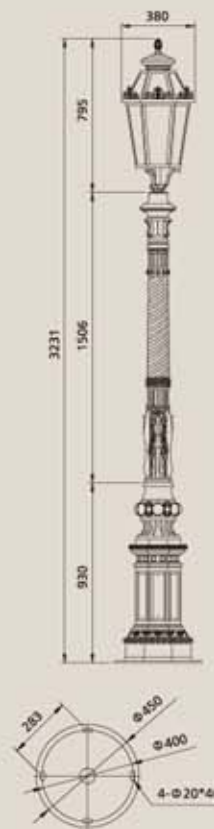

RHS-15536



RHS-15532



RHS-15530

產品特點:

- 燈體材質: 優質鋁合金鑄造成型, 經防腐處理后, 采用防UV靜電粉末噴塗;
- 透光罩: 磨砂玻璃燈罩;
- 緊固件: 不鏽鋼材質, 强度高, 防腐蝕能力強;
- 適用光源: LED 36-45W
- 顏色: 沙黑色

PRODUCTS CHARACTERS:

- Body: Made of high quality cast aluminum alloy with treatment of corrosion protection and UV-proof powder coating.
- Diffuser: Frosted glass.
- Fastener: Made of stainless steel with high intensity and corrosion protection.
- Lamp: LED 36-45W
- Finish: Matt black as standard. Matt coffee, dark grey, dark bronze, matt grey any other RAL color is available upon request.

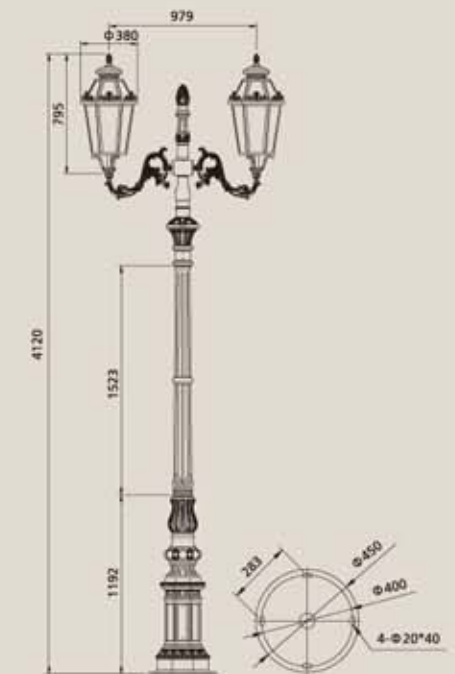

產品特點:

- 燈體材質: 優質鋁合金鑄造型, 經防腐處理后, 采用防UV靜電粉末噴塗;
- 透光罩: PC奶白燈罩, 奶白塑料燈罩;
- 緊固件: 不鏽鋼材質, 强度高, 防腐蝕能力強;
- 適用光源: LED 24-45W
- 顏色: 深灰色

PRODUCTS CHARACTERS:

- Body: Made of high quality cast aluminum alloy with treatment of corrosion protection and UV-proof powder coating.
- Diffuser: Opal polycarbonate, Opal plastic.
- Fastener: Made of stainless steel with high intensity and corrosion protection.
- Lamp: LED 24-45W
- Finish: Dark grey as standard. Matt coffee, matt black, dark bronze, matt grey any other RAL color is available upon request.

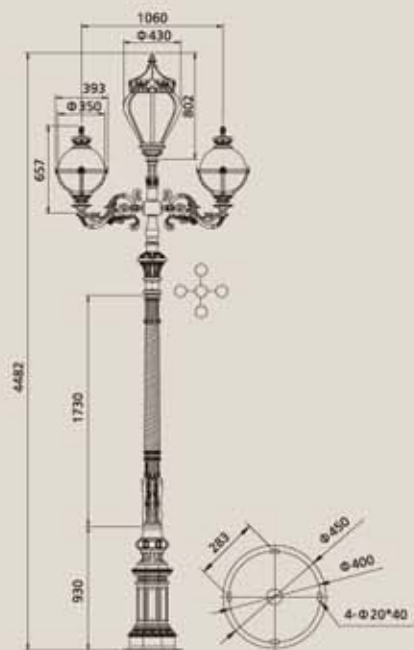

RHS-15539

產品特點:

- 燈體材質: 優質鋁合金鑄造型, 經防腐處理后, 采用防UV靜電粉末噴塗;
- 透光罩: PC透明燈罩;
- 緊固件: 不鏽鋼材質, 强度高, 防腐蝕能力強;
- 適用光源: LED 36-45W
- 顏色: 深灰色

PRODUCTS CHARACTERS:

- Body: Made of high quality cast aluminum alloy with treatment of corrosion protection and UV-proof powder coating.
- Diffuser: Clear polycarbonate.
- Fastener: Made of stainless steel with high intensity and corrosion protection.
- Lamp: LED 36-45W
- Finish: Matt grey as standard. Matt coffee, dark grey, dark bronze, matt black any other RAL color is available upon request.

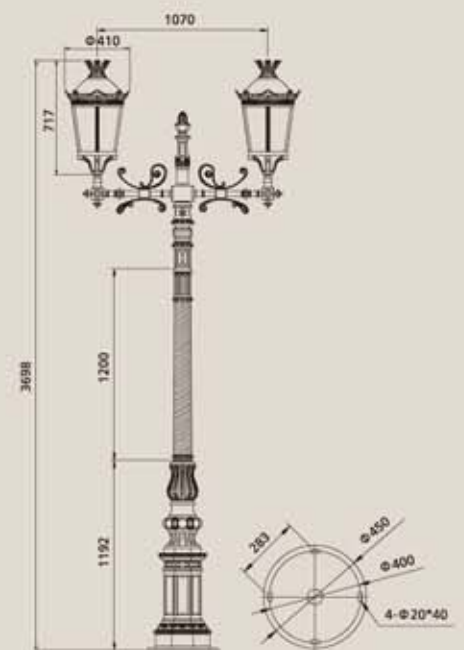

RHS-15534

產品特點:

- 燈體材質: 優質鋁合金鑄造成型, 經防腐處理后, 採用防UV靜電粉末噴塗;
- 透光罩: PC奶白燈罩;
- 緊固件: 不鏽鋼材質, 强度高, 防腐蝕能力強;
- 適用光源: LED 15-24W
- 顏色: 沙黑色

PRODUCTS CHARACTERS:

- Body: Made of high quality cast aluminum alloy with treatment of corrosion protection and UV-proof powder coating.
- Diffuser: Opal polycarbonate.
- Fastener: Made of stainless steel with high intensity and corrosion protection.
- Lamp: LED 15-24W
- Finish: Matt black as standard. Matt coffee, dark grey, dark bronze, matt grey any other RAL color is available upon request.

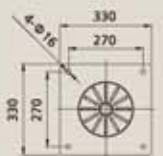

RHS-17325



RHS-14039

產品特點:

- 燈體材質: 優質鋁合金鑄造成型, 經防腐處理后, 採用防UV靜電粉末噴塗;
- 透光罩: 奶白塑料燈罩;
- 緊固件: 不鏽鋼材質, 强度高, 防腐蝕能力強;
- 適用光源: LED 15-24W
- 顏色: 紅古銅色

PRODUCTS CHARACTERS:

- Body: Made of high quality cast aluminum alloy with treatment of corrosion protection and UV-proof powder coating.
- Diffuser: Opal plastic.
- Fastener: Made of stainless steel with high intensity and corrosion protection.
- Lamp: LED 15-24W
- Finish: Red bronze as standard. Matt coffee, matt black, dark grey, matt grey any other RAL color is available upon request.

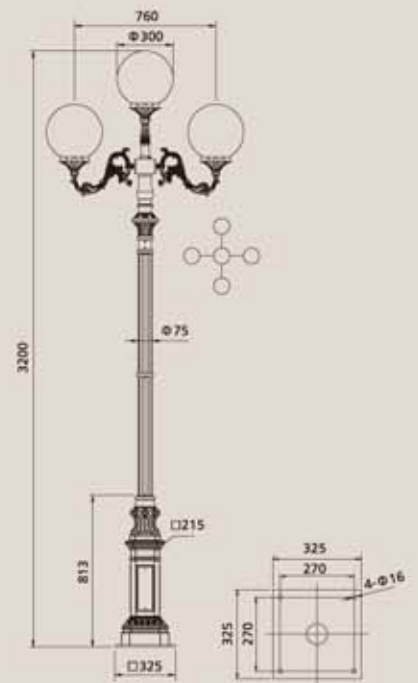

RHS-14052

產品特點:

- 燈體材質: 優質鋁合金鑄造成型, 經防腐處理后, 采用防UV靜電粉末噴塗;
- 透光罩: 磨砂玻璃燈罩;
- 緊固件: 不鏽鋼材質, 强度高, 防腐蝕能力強;
- 適用光源: LED 15-24W
- 顏色: 深灰色/沙銀色

PRODUCTS CHARACTERS:

- Body: Made of high quality cast aluminum alloy with treatment of corrosion protection and UV-proof powder coating.
- Diffuser: Frosted glass.
- Fastener: Made of stainless steel with high intensity and corrosion protection.
- Lamp: LED 15-24W
- Finish: Matt black as standard. Matt coffee, dark grey, dark bronze, matt grey any other RAL color is available upon request.

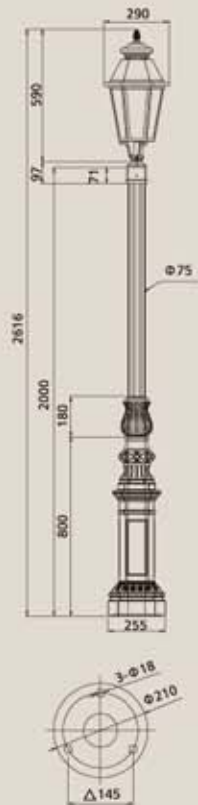

RHS-17326

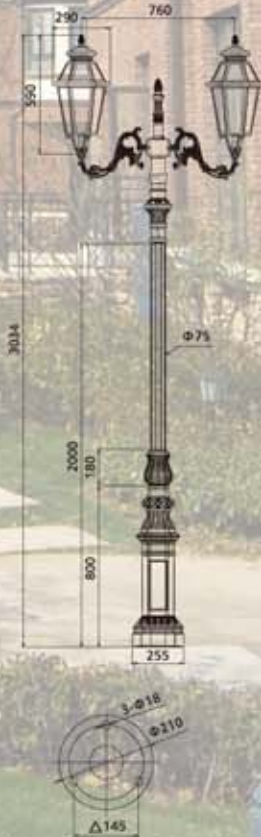

RHS-17327



產品特點:

- 燈體材質: 優質鋁合金鑄造成型, 經防腐處理后, 采用防UV靜電粉末噴塗;
- 透光罩: 磨砂玻璃燈罩/奶白塑料燈罩;
- 緊固件: 不鏽鋼材質, 强度高, 防腐蝕能力強;
- 適用光源: LED 15-24W
- 顏色: 沙黑色

PRODUCTS CHARACTERS:

- Body: Made of high quality cast aluminum alloy with treatment of corrosion protection and UV-proof powder coating.
- Diffuser: Frosted glass/Opal plastic.
- Fastener: Made of stainless steel with high intensity and corrosion protection.
- Lamp: LED 15-24W
- Finish: Matt black as standard. Matt coffee, dark grey, dark bronze, matt grey any other RAL color is available upon request.

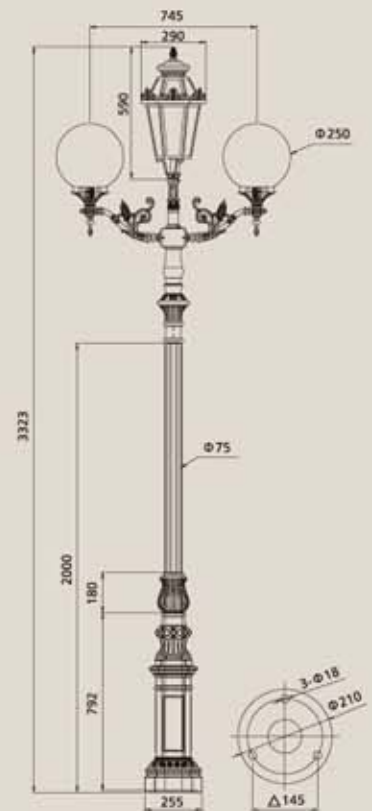

RHS-17328



產品特點:

- 燈體材質: 優質鋁合金鑄造成型, 經防腐處理后, 采用防UV靜電粉末噴塗;
- 透光罩: PC奶白燈罩;
- 反光器: 高純鋁反光器, 經陽極氧化處理;
- 緊固件: 不鏽鋼材質, 强度高, 防腐蝕能力強;
- 適用光源: LED 36-45W
- 顏色: 沙黑色/咖啡色

PRODUCTS CHARACTERS:

- Body: Made of high quality cast aluminum alloy with treatment of corrosion protection and UV-proof powder coating.
- Diffuser: Opal polycarbonate.
- Reflector: Made of anodized high pure aluminum.
- Fastener: Made of stainless steel with high intensity and corrosion protection.
- Lamp: LED 36-45W
- Finish: Matt grey as standard Matt coffee, dark grey, dark bronze, matt black any other RAL color is available upon request.



RHS-17329

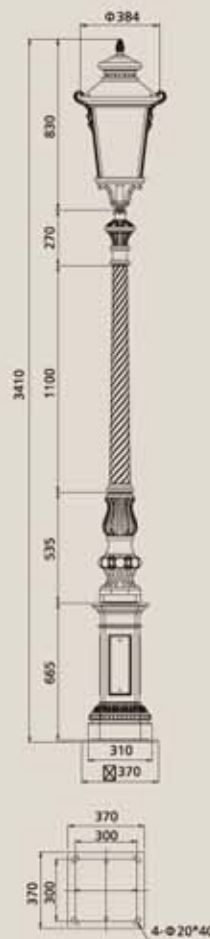

RHS-17330



產品特點:

- 燈體材質: 優質鋁合金鑄造成型, 經防腐處理后, 采用防UV靜電粉末噴塗;
- 透光罩: 奶白塑料燈罩;
- 緊固件: 不鏽鋼材質, 强度高, 防腐蝕能力強;
- 適用光源: LED 24-36W
- 顏色: 深灰色

PRODUCTS CHARACTERS:

- Body: Made of high quality cast aluminum alloy with treatment of corrosion protection and UV-proof powder coating.
- Diffuser: Opal plastic.
- Fastener: Made of stainless steel with high intensity and corrosion protection.
- Lamp: LED 24-36W
- Finish: Dark grey as standard Matt coffee, matt grey, dark bronze, matt black any other RAL color is available upon request.



RHS-17331

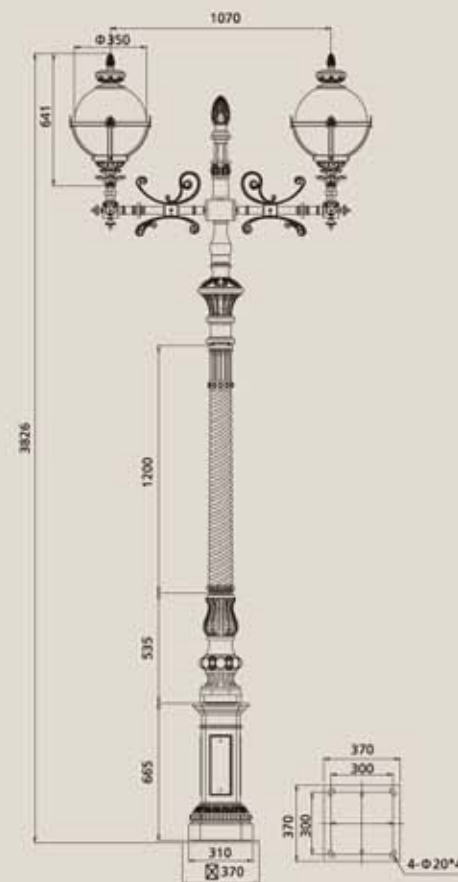

產品特點:

- 燈體材質: 優質鋁合金鑄造成型, 經防腐處理后, 采用防UV靜電粉末噴塗;
- 透光罩: 磨砂玻璃燈罩;
- 緊固件: 不鏽鋼材質, 强度高, 防腐蝕能力強;
- 適用光源: LED 24-36W
- 顏色: 沙黑色

PRODUCTS CHARACTERS:

- Body: Made of high quality cast aluminum alloy with treatment of corrosion protection and UV-proof powder coating.
- Diffuser: Frosted glass.
- Fastener: Made of stainless steel with high intensity and corrosion protection.
- Lamp: LED 24-36W
- Finish: Matt black as standard. Matt coffee, dark grey, dark bronze, matt grey any other RAL color is available upon request.



RHS-17332



RHS-17333

產品特點:

- 燈體材質: 燈具優質鋁合金鑄造成型, 燈杆鐵錫熱鍍鋅處理, 經防腐處理后, 采用防UV靜電粉末噴塗;
- 透光罩: PMMA燈罩;
- 緊固件: 不鏽鋼材質, 强度高, 防腐蝕能力強;
- 適用光源: LED 36-45W
- 顏色: 沙黑色

PRODUCTS CHARACTERS:

- Body: Luminarie is made of high quality cast aluminum, light pole is made of hot-dip galvanized iron.
- Diffuser: PMMA.
- Fastener: Made of stainless steel with high intensity and corrosion protection.
- Lamp: LED 36-45W
- Finish: Matt black as standard. Matt coffee, dark grey, dark bronze, matt grey any other RAL color is available upon request.

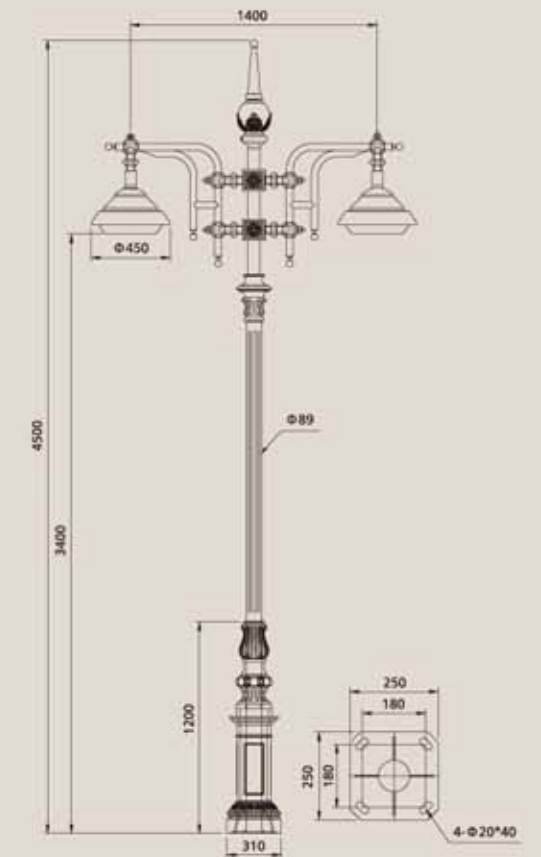

產品特點:

- 燈體材質: 優質鋁合金鑄造成型, 經防腐處理后, 採用防UV靜電粉末噴塗;
- 透光罩: PC奶白燈罩/奶白塑料燈罩;
- 緊固件: 不鏽鋼材質, 强度高, 防腐蝕能力強;
- 適用光源: LED 24-36W
- 顏色: 沙黑色

PRODUCTS CHARACTERS:

- Body: Made of high quality cast aluminum alloy with treatment of corrosion protection and UV-proof powder coating.
- Diffuser: Opal polycarbonate/Opal plastic.
- Fastener: Made of stainless steel with high intensity and corrosion protection.
- Lamp: LED 24-36W
- Finish: Matt black as standard. Matt coffee, dark grey, dark bronze, matt grey any other RAL color is available upon request.

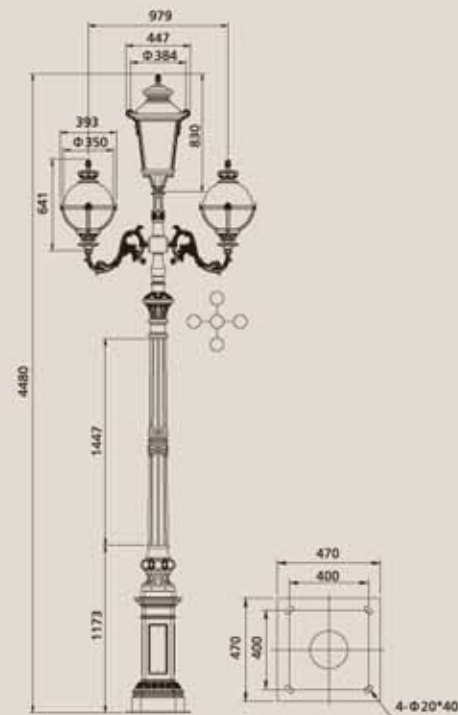

RHS-15490

產品特點:

- 燈體材質: 優質鋁合金鑄造成型, 經防腐處理后, 採用防UV靜電粉末噴塗;
- 透光罩: 磨砂玻璃燈罩/PC奶白燈罩;
- 緊固件: 不鏽鋼材質, 强度高, 防腐蝕能力強;
- 適用光源: LED 36-45W
- 顏色: 深灰色

PRODUCTS CHARACTERS:

- Body: Made of high quality cast aluminum alloy with treatment of corrosion protection and UV-proof powder coating.
- Diffuser: Frosted glass/Opal polycarbonate.
- Fastener: Made of stainless steel with high intensity and corrosion protection.
- Lamp: LED 36-45W
- Finish: Dark grey as standard. Matt coffee, matt black, dark bronze, matt grey any other RAL color is available upon request.



RHS-15489

RHS-15505

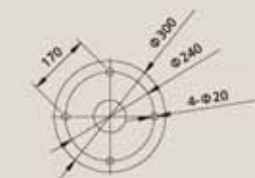
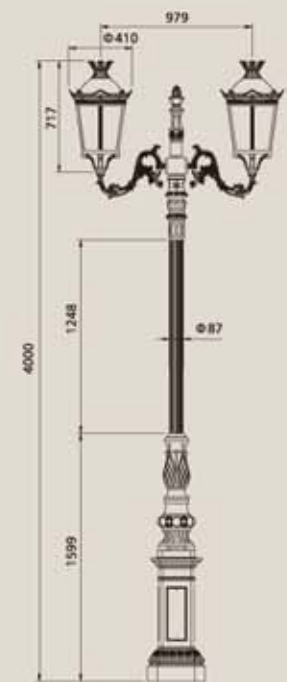
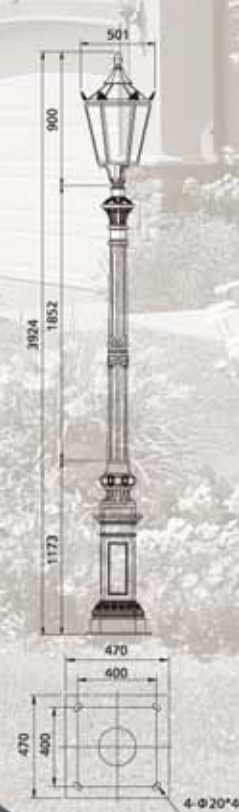

產品特點:

- 燈體材質: 優質鋁合金鑄造成型, 經防腐處理后, 采用防UV靜電粉末噴塗;
- 透光罩: PC奶白燈罩;
- 緊固件: 不鏽鋼材質, 强度高, 防腐蝕能力強;
- 適用光源: LED 15W
- 顏色: 紅古銅色

PRODUCTS CHARACTERS:

- Body: Made of high quality cast aluminum alloy with treatment of corrosion protection and UV-proof powder coating.
- Diffuser: Opal polycarbonate.
- Fastener: Made of stainless steel with high intensity and corrosion protection.
- Lamp: LED 15W
- Finish: Red bronze as standard. Matt coffee, matt black, dark grey, matt grey any other RAL color is available upon request.

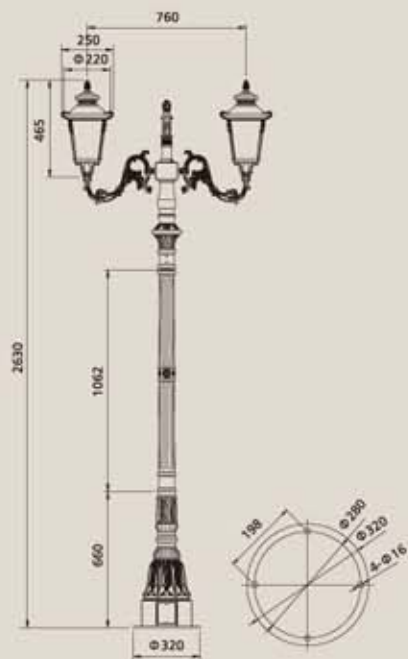

RHS-14189

產品特點:

- 燈體材質: 優質鋁合金鑄造成型, 經防腐處理后, 采用防UV靜電粉末噴塗;
- 透光罩: 磨砂玻璃燈罩;
- 緊固件: 不鏽鋼材質, 强度高, 防腐蝕能力強;
- 適用光源: LED 15-24W
- 顏色: 沙銀色/深灰色

PRODUCTS CHARACTERS:

- Body: Made of high quality cast aluminum alloy with treatment of corrosion protection and UV-proof powder coating.
- Diffuser: Frosted glass.
- Fastener: Made of stainless steel with high intensity and corrosion protection.
- Lamp: LED 15-24W
- Finish: Dark gray as standard. Matt coffee, matt black, dark bronze, matt grey any other RAL color is available upon request.



RHS-17334

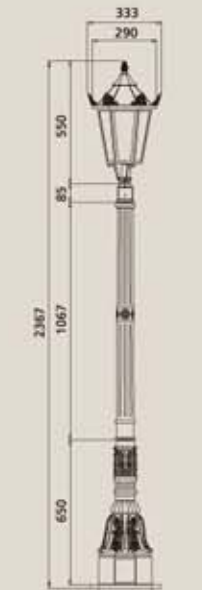

RHS-17335

產品特點:

- 燈體材質: 優質鋁合金鑄造成型, 經防腐處理后, 采用防UV靜電粉末噴塗;
- 透光罩: PC奶白燈罩/PC磨砂燈罩;
- 緊固件: 不鏽鋼材質, 强度高, 防腐蝕能力強;
- 適用光源: LED 15-24W
- 顏色: 深灰色

PRODUCTS CHARACTERS:

- Body: Made of high quality cast aluminum alloy with treatment of corrosion protection and UV-proof powder coating
- Diffuser: Opal polycarbonate/Frosted polycarbonate
- Fastener: Made of stainless steel with high intensity and corrosion protection
- Lamp: LED 15-24W
- Finish: Dark grey as standard. Matt grey, Matt coffee, Matt black, Matt bronze any other RAL color is available upon request.



RHS-17336

RHS-16473



產品特點:

- 燈體材質: 優質鋁合金鑄造成型, 經防腐處理后, 采用防UV靜電粉末噴塗;
- 透光罩: 磨砂玻璃燈罩;
- 緊固件: 不鏽鋼材質, 强度高, 防腐蝕能力強;
- 適用光源: LED 15-24W
- 顏色: 沙黃色/深灰色

PRODUCTS CHARACTERS:

- Body: Made of high quality cast aluminum alloy with treatment of corrosion protection and UV-proof powder coating.
- Diffuser: Frosted glass.
- Fastener: Made of stainless steel with high intensity and corrosion protection.
- Lamp: LED 15-24W
- Finish: Matt coffee as standard. Matt grey, dark grey, dark bronze, matt black any other RAL color is available upon request.



RHS-16471

RHS-17337

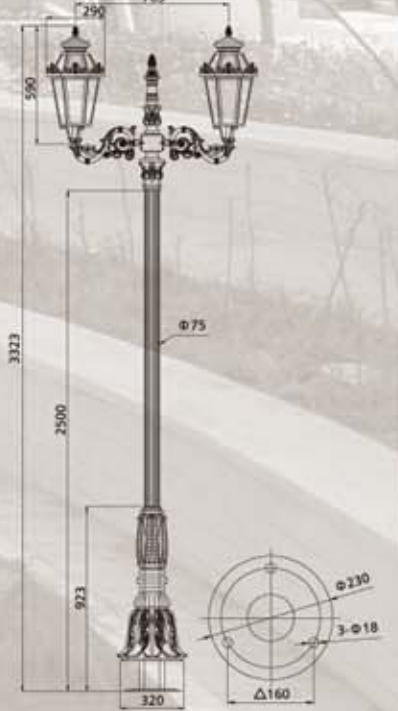
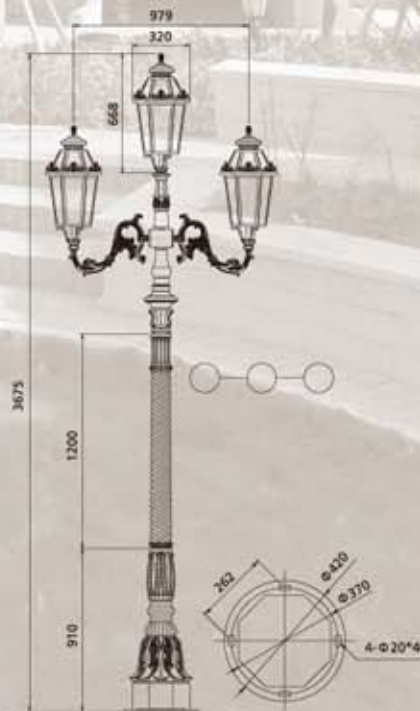

產品特點:

- 燈體材質: 優質鋁合金鑄造成型, 經防腐處理后, 采用防UV靜電粉末噴塗;
- 透光罩: PC奶白燈罩;
- 緊固件: 不銹鋼材質, 强度高, 防腐蝕能力強;
- 適用光源: LED 15-24W
- 顏色: 沙銀色

PRODUCTS CHARACTERS:

- Body: Made of high quality cast aluminum alloy with treatment of corrosion protection and UV-proof powder coating.
- Diffuser: Opal polycarbonate.
- Fastener: Made of stainless steel with high intensity and corrosion protection.
- Lamp: LED 15-24W
- Finish: Dark grey as standard. Matt coffee, matt black, dark bronze, matt grey any other RAL color is available upon request.

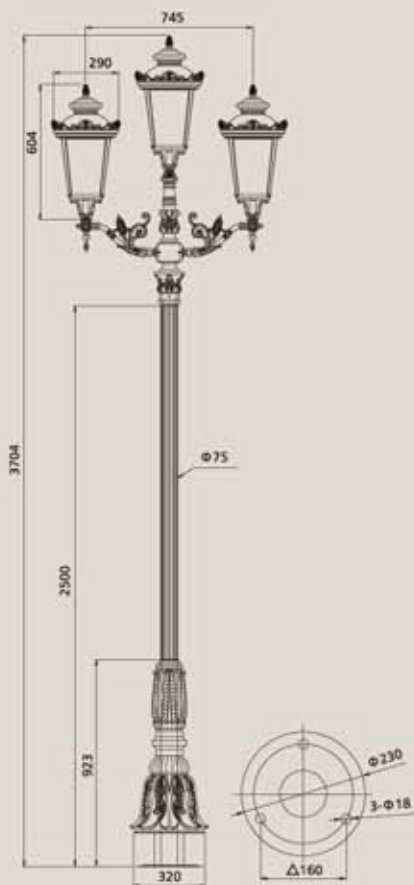

RHS-17338

產品特點:

- 燈體材質: 優質鋁合金鑄造成型, 經防腐處理后, 采用防UV靜電粉末噴塗;
- 透光罩: 磨砂玻璃燈罩/PC奶白燈罩;
- 緊固件: 不銹鋼材質, 强度高, 防腐蝕能力強;
- 適用光源: LED 24-36W
- 顏色: 咖啡色/深灰色

PRODUCTS CHARACTERS:

- Body: Made of high quality cast aluminum alloy with treatment of corrosion protection and UV-proof powder coating.
- Diffuser: Frosted glass/Opal polycarbonate.
- Fastener: Made of stainless steel with high intensity and corrosion protection.
- Lamp: LED 24-36W
- Finish: Matt coffee as standard. Matt grey, dark grey, dark bronze, matt black any other RAL color is available upon request.



RHS-15602

RHS-15600

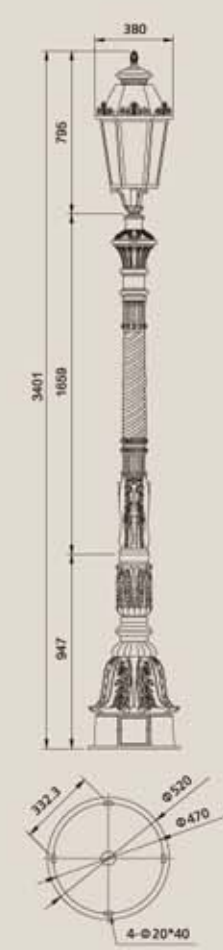

產品特點:

- 燈體材質: 優質鋁合金鑄造型, 經防腐處理后, 采用防UV靜電粉末噴塗;
- 透光罩: PC奶白燈罩;
- 緊固件: 不鏽鋼材質, 强度高, 防腐蝕能力強;
- 適用光源: LED 24-36W
- 顏色: 深灰色

PRODUCTS CHARACTERS:

- Body: Made of high quality cast aluminum alloy with treatment of corrosion protection and UV-proof powder coating.
- Diffuser: Opal polycarbonate.
- Fastener: Made of stainless steel with high intensity and corrosion protection.
- Lamp: LED 24-36W
- Finish: Dark grey as standard. Matt coffee, matt black, dark bronze, matt grey any other RAL color is available upon request.

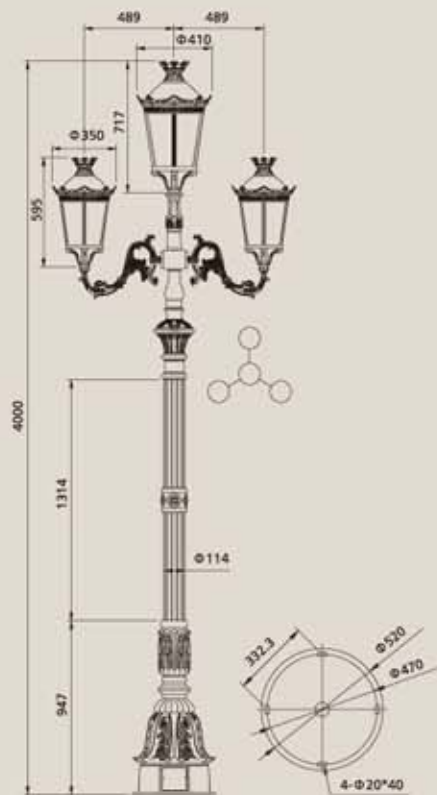

RHS-15595

產品特點:

- 燈體材質: 優質鋁合金鑄造型, 經防腐處理后, 采用防UV靜電粉末噴塗;
- 透光罩: PC奶白燈罩;
- 緊固件: 不鏽鋼材質, 强度高, 防腐蝕能力強;
- 適用光源: LED 24-36W
- 顏色: 深灰色

PRODUCTS CHARACTERS:

- Body: Made of high quality cast aluminum alloy with treatment of corrosion protection and UV-proof powder coating.
- Diffuser: Opal polycarbonate.
- Fastener: Made of stainless steel with high intensity and corrosion protection.
- Lamp: LED 24-36W
- Finish: Dark grey as standard. Matt coffee, matt black, dark bronze, matt grey any other RAL color is available upon request.

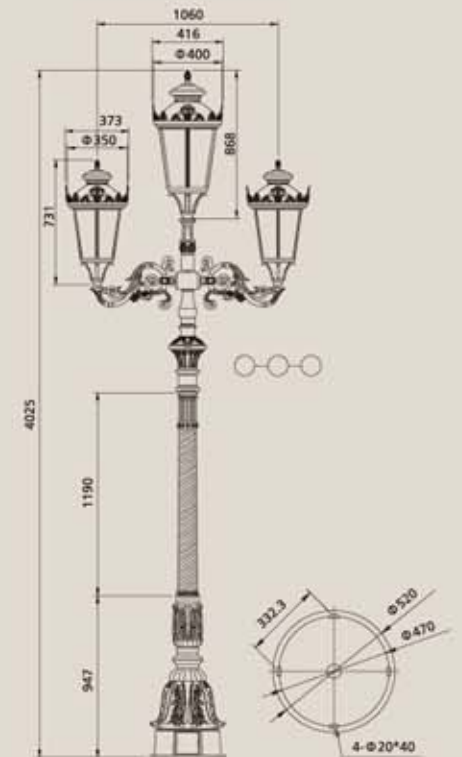

RHS-15604

產品特點:

- 燈體材質: 優質鋁合金鑄造型, 經防腐處理后, 采用防UV靜電粉末噴塗;
- 透光罩: 磨砂玻璃燈罩;
- 緊固件: 不鏽鋼材質, 强度高, 防腐蝕能力強;
- 適用光源: LED 36-45W
- 顏色: 沙銀色

PRODUCTS CHARACTERS:

- Body: Made of high quality cast aluminum alloy with treatment of corrosion protection and UV-proof powder coating.
- Diffuser: Frosted glass.
- Fastener: Made of stainless steel with high intensity and corrosion protection.
- Lamp: LED 36-45W
- Finish: Matt grey as standard. Matt coffee, dark grey, dark bronze, matt black any other RAL color is available upon request.



RHS-15609

產品特點:

- 燈體材質: 優質鋁合金鑄造型, 經防腐處理后, 采用防UV靜電粉末噴塗;
- 透光罩: PC奶白燈罩/奶白塑料燈罩;
- 緊固件: 不鏽鋼材質, 强度高, 防腐蝕能力強;
- 適用光源: LED 15-24W
- 顏色: 沙黑色/深灰色

PRODUCTS CHARACTERS:

- Body: Made of high quality cast aluminum alloy with treatment of corrosion protection and UV-proof powder coating.
- Diffuser: Opal polycarbonate/Opal plastic.
- Fastener: Made of stainless steel with high intensity and corrosion protection.
- Lamp: LED 15-24W
- Finish: Matt grey as standard. Matt coffee, dark grey, dark bronze, matt black any other RAL color is available upon request.



RHS-14058

RHS-14067

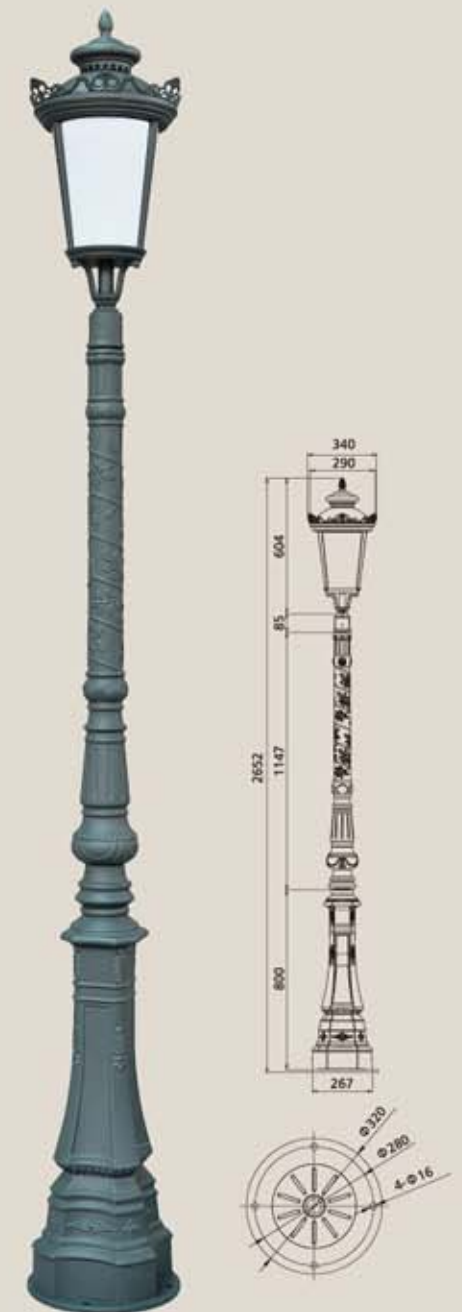
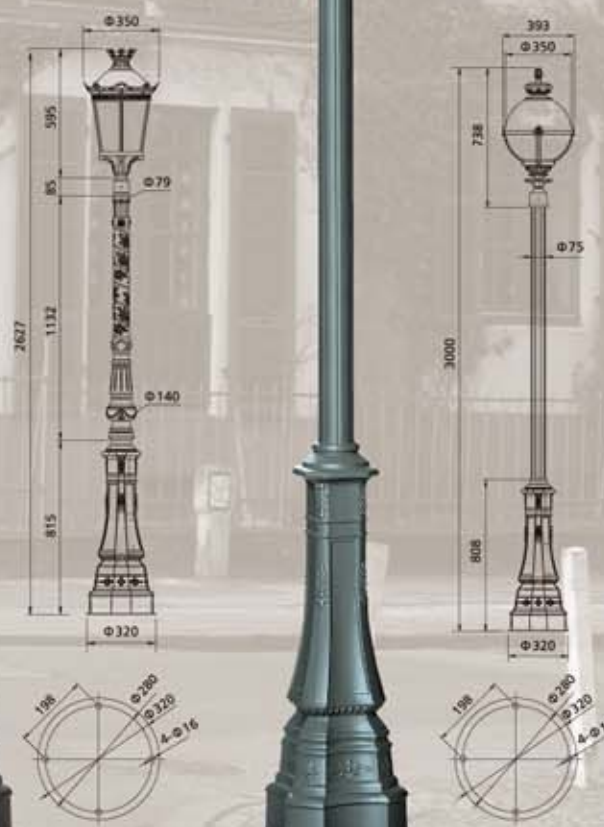

RHS-17339

產品特點:

- 燈體材質: 優質鋁合金鑄造成型, 經防腐處理后, 采用防UV靜電粉末噴塗;
- 透光罩: PC磨砂燈罩/PC透明燈罩;
- 反光器: 高純鋁反光器, 經陽極氧化處理;
- 緊固件: 不鏽鋼材質, 强度高, 防腐蝕能力強;
- 適用光源: LED COB 36W/LED 36-45W
- 顏色: 深灰色/沙銀色

PRODUCTS CHARACTERS:

- Body: Made of high quality cast aluminum alloy with treatment of corrosion protection and UV-proof powder coating.
- Diffuser: Frosted polycarbonate/Clear polycarbonate.
- Reflector: Made of anodized high pure aluminum.
- Fastener: Made of stainless steel with high intensity and corrosion protection.
- Lamp: LED COB 36W/LED 36-45W
- Finish: Matt grey as standard. Matt coffee, dark grey, dark bronze, matt black any other RAL color is available upon request.

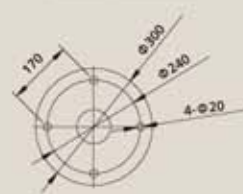
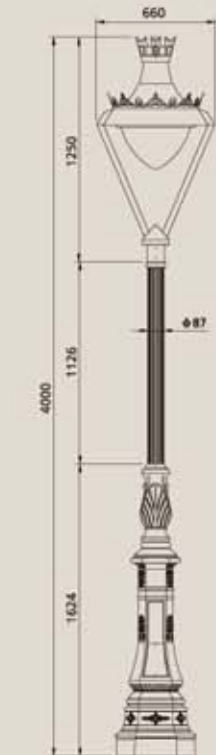

RHS-15460

RHS-15473



產品特點:

- 燈體材質: 優質鋁合金鑄造成型, 經防腐處理后, 采用防UV靜電粉末噴塗;
- 透光罩: 磨砂玻璃燈罩;
- 緊固件: 不鏽鋼材質, 强度高, 防腐蝕能力強;
- 適用光源: LED 15-24W
- 顏色: 沙黑色/沙銀色

PRODUCTS CHARACTERS:

- Body: Made of high quality cast aluminum alloy with treatment of corrosion protection and UV-proof powder coating.
- Diffuser: Frosted glass.
- Fastener: Made of stainless steel with high intensity and corrosion protection.
- Lamp: LED 15-24W
- Finish: Matt black as standard. Matt coffee, dark grey, dark bronze, matt grey any other RAL color is available upon request.



RHS-17340

RHS-17341



產品特點:

- 燈體材質: 優質鋁合金鑄造成型, 經防腐處理后, 采用防UV靜電粉末噴塗;
- 透光罩: PC奶白燈罩;
- 緊固件: 不鏽鋼材質, 强度高, 防腐蝕能力強;
- 適用光源: LED 15-24W
- 顏色: 沙黑色

PRODUCTS CHARACTERS:

- Body: Made of high quality cast aluminum alloy with treatment of corrosion protection and UV-proof powder coating.
- Diffuser: Opal polycarbonate.
- Fastener: Made of stainless steel with high intensity and corrosion protection.
- Lamp: LED 15-24W
- Finish: Matt black as standard. Matt coffee, dark grey, dark bronze, matt grey any other RAL color is available upon request.

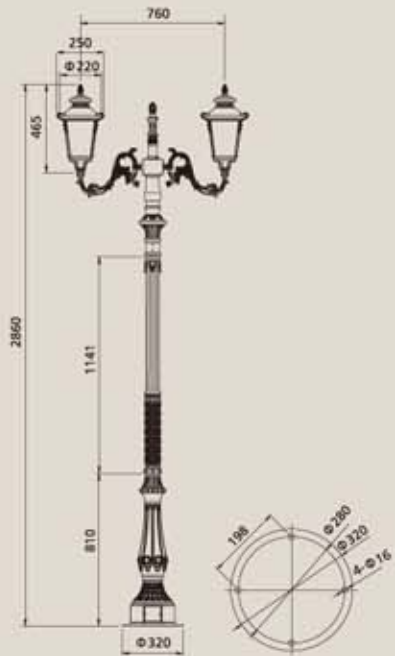

RHS-14114

產品特點:

- 燈體材質: 優質鋁合金鑄造成型, 經防腐處理后, 采用防UV靜電粉末噴塗;
- 透光罩: 磨砂玻璃燈罩;
- 緊固件: 不鏽鋼材質, 强度高, 防腐蝕能力強;
- 適用光源: LED 24-36W
- 顏色: 深灰色/咖啡色

PRODUCTS CHARACTERS:

- Body: Made of high quality cast aluminum alloy with treatment of corrosion protection and UV-proof powder coating.
- Diffuser: Frosted glass.
- Fastener: Made of stainless steel with high intensity and corrosion protection.
- Lamp: LED 24-36W
- Finish: Dark grey as standard. Matt coffee, matt black, dark bronze, matt grey any other RAL color is available upon request.

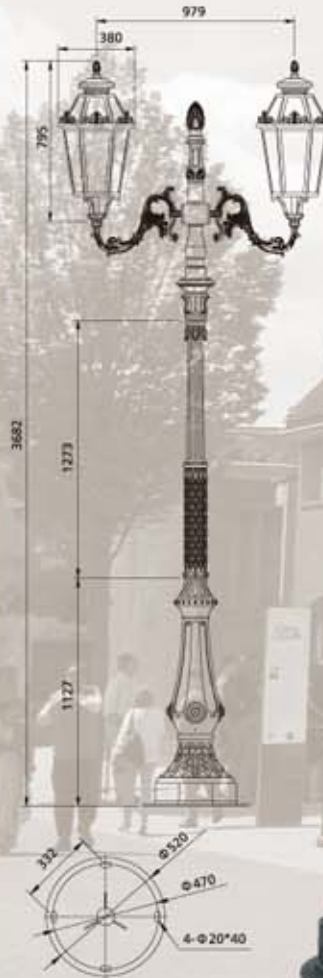

RHS-15582

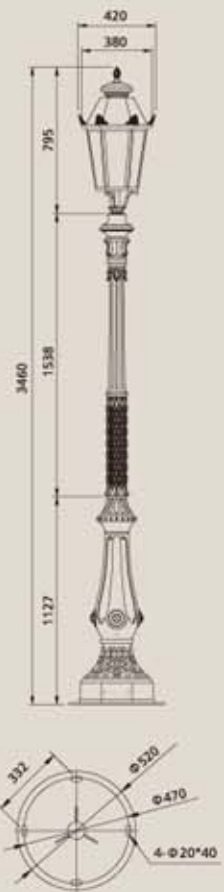

RHS-15587

產品特點:

- 燈體材質: 優質鋁合金鑄造成型, 經防腐處理后, 采用防UV靜電粉末噴塗;
- 透光罩: PC透明燈罩/PC奶白燈罩;
- 緊固件: 不鏽鋼材質, 强度高, 防腐蝕能力強;
- 適用光源: LED 24-36W
- 顏色: 沙銀色

PRODUCTS CHARACTERS:

- Body: Made of high quality cast aluminum alloy with treatment of corrosion protection and UV-proof powder coating.
- Diffuser: Clear polycarbonate/Opal polycarbonate.
- Fastener: Made of stainless steel with high intensity and corrosion protection.
- Lamp: LED 24-36W
- Finish: Matt grey as standard. Matt coffee, dark grey, dark bronze, matt black any other RAL color is available upon request.



RHS-15583



RHS-15584

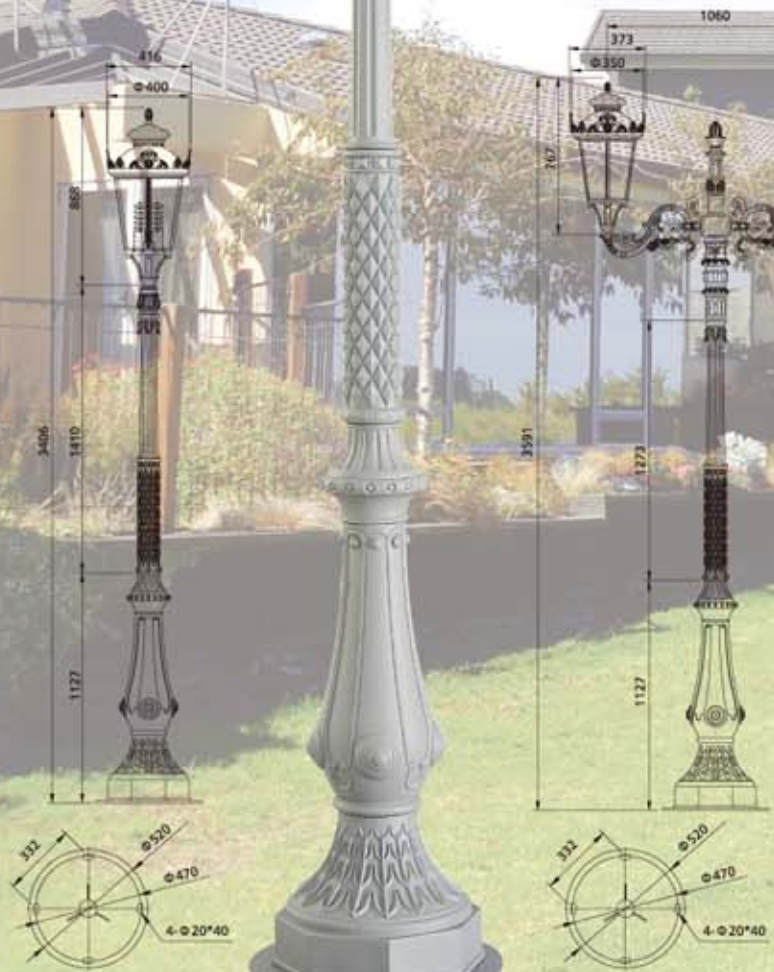

產品特點:

- 燈體材質: 優質鋁合金鑄造成型, 經防腐處理后, 采用防UV靜電粉末噴塗;
- 透光罩: PC透明燈罩/PC奶白燈罩;
- 緊固件: 不鏽鋼材質, 强度高, 防腐蝕能力強;
- 適用光源: LED 24-36W
- 顏色: 沙黑色

PRODUCTS CHARACTERS:

- Body: Made of high quality cast aluminum alloy with treatment of corrosion protection and UV-proof powder coating.
- Diffuser: Opal polycarbonate.
- Fastener: Made of stainless steel with high intensity and corrosion protection.
- Lamp: LED 24-36W
- Finish: Matt black as standard. Matt coffee, dark grey, dark bronze, matt grey any other RAL color is available upon request.



RHS-15586

RHS-15585



產品特點:

- 燈體材質: 優質鋁合金鑄造成型, 經防腐處理后, 采用防UV靜電粉末噴塗;
- 透光罩: 磨砂玻璃燈罩;
- 緊固件: 不鏽鋼材質, 强度高, 防腐蝕能力強;
- 適用光源: LED 15-24W
- 顏色: 沙銀色/沙黑色

PRODUCTS CHARACTERS:

- Body: Made of high quality cast aluminum alloy with treatment of corrosion protection and UV-proof powder coating.
- Diffuser: Frosted glass.
- Fastener: Made of stainless steel with high intensity and corrosion protection.
- Lamp: LED 15-24W
- Finish: Matt grey as standard. Matt coffee, dark grey, dark bronze, matt black any other RAL color is available upon request.

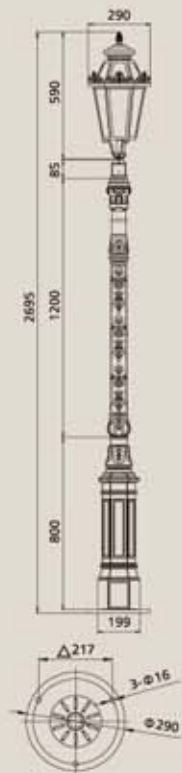

RHS-17342

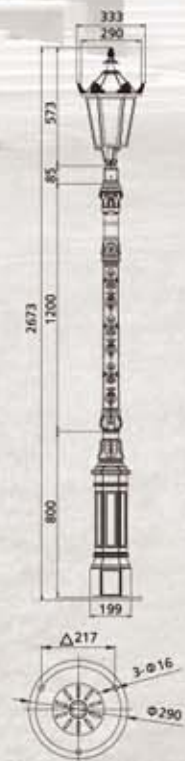

RHS-17343

產品特點:

- 燈體材質: 優質鋁合金鑄造成型, 經防腐處理后, 采用防UV靜電粉末噴塗;
- 透光罩: 磨砂玻璃燈罩;
- 緊固件: 不鏽鋼材質, 强度高, 防腐蝕能力強;
- 適用光源: LED 24-36W
- 顏色: 紅古銅色

PRODUCTS CHARACTERS:

- Body: Made of high quality cast aluminum alloy with treatment of corrosion protection and UV-proof powder coating.
- Diffuser: Frosted glass.
- Fastener: Made of stainless steel with high intensity and corrosion protection.
- Lamp: LED 24-36W
- Finish: Matt grey as standard. Matt coffee, dark grey, dark bronze, matt black any other RAL color is available upon request.



RHS-15627

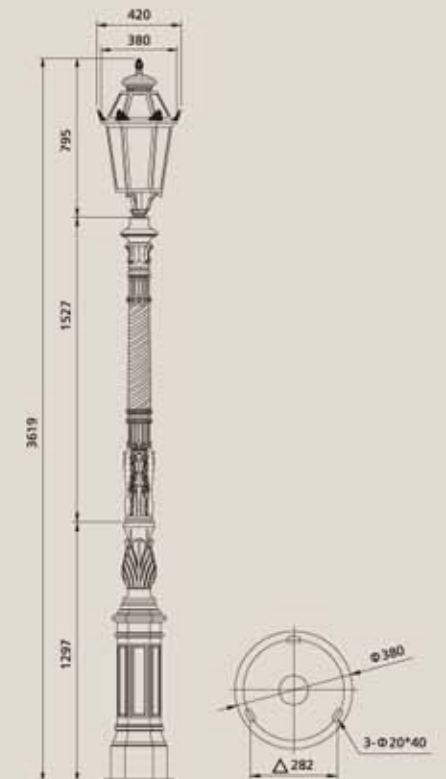

產品特點:

- 燈體材質: 優質鋁合金鑄造成型, 經防腐處理后, 采用防UV靜電粉末噴塗;
- 透光罩: PC奶白燈罩/奶白塑料燈罩;
- 緊固件: 不鏽鋼材質, 强度高, 防腐蝕能力強;
- 適用光源: LED 24-36W
- 顏色: 古銅色

PRODUCTS CHARACTERS:

- Body: Made of high quality cast aluminum alloy with treatment of corrosion protection and UV-proof powder coating.
- Diffuser: Opal polycarbonate/Opal plastic.
- Fastener: Made of stainless steel with high intensity and corrosion protection.
- Lamp: LED 24-36W
- Finish: Matt grey as standard. Matt coffee, dark grey, dark bronze, matt black any other RAL color is available upon request.

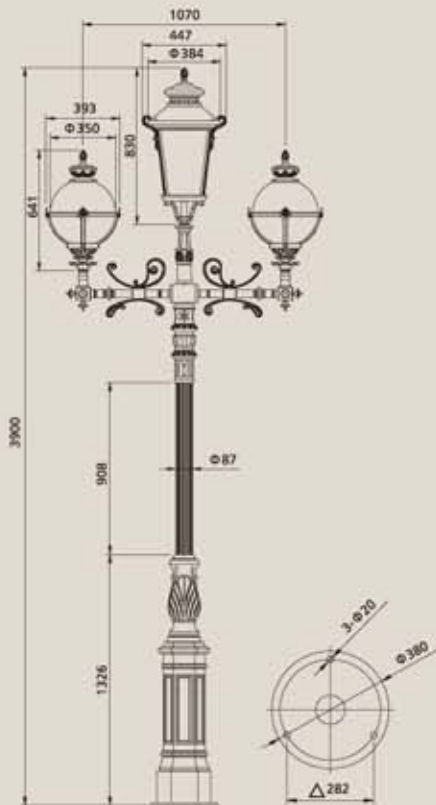

RHS-15625

產品特點:

- 燈體材質: 優質鋁合金鑄造成型, 經防腐處理后, 采用防UV靜電粉末噴塗;
- 透光罩: PC奶白燈罩;
- 緊固件: 不鏽鋼材質, 强度高, 防腐蝕能力強;
- 適用光源: LED 24-36W
- 顏色: 紅古銅色

PRODUCTS CHARACTERS:

- Body: Made of high quality cast aluminum alloy with treatment of corrosion protection and UV-proof powder coating. Diffuser: Opal polycarbonate.
- Fastener: Made of stainless steel with high intensity and corrosion protection.
- Lamp: LED 24-36W
- Finish: Red bronze as standard. Matt coffee, matt black, dark grey, matt grey any other RAL color is available upon request.

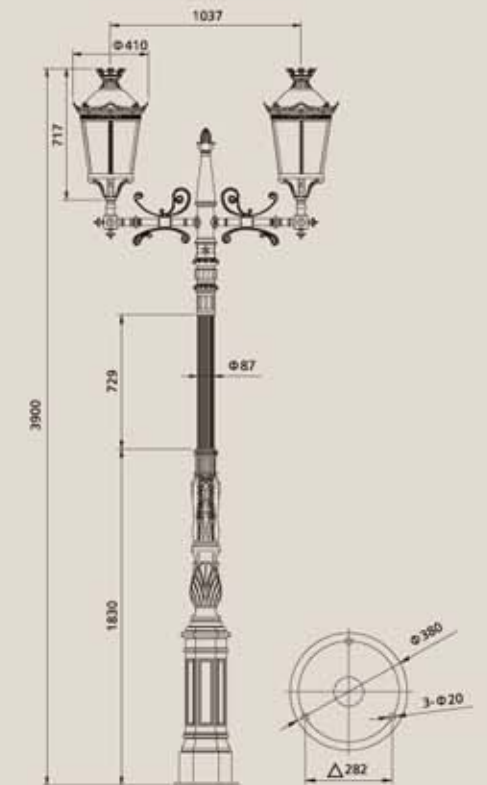

RHS-15622

產品特點:

- 燈體材質: 優質鋁合金鑄造成型, 經防腐處理后, 采用防UV靜電粉末噴塗;
- 透光罩: 磨砂玻璃燈罩/PC透明燈罩/PC奶白燈罩;
- 緊固件: 不鏽鋼材質, 强度高, 防腐蝕能力強;
- 適用光源: LED 24-36W
- 顏色: 咖啡色/沙銀色/深灰色/

PRODUCTS CHARACTERS:

- Body: Made of high quality cast aluminum alloy with treatment of corrosion protection and UV-proof powder coating.
- Diffuser: Frosted glass/Clear polycarbonate/Opal polycarbonate.
- Fastener: Made of stainless steel with high intensity and corrosion protection.
- Lamp: LED 24-36W
- Finish: Dark grey as standard. Matt coffee, matt black, dark bronze, matt grey any other RAL color is available upon request.



RHS-15636



RHS-15634



RHS-15629



RHS-15639



RHS-15640

產品特點:

- 燈體材質: 優質鋁合金鑄造成型, 經防腐處理后, 采用防UV靜電粉末噴塗;
- 透光罩: PC奶白燈罩;
- 緊固件: 不鏽鋼材質, 强度高, 防腐蝕能力強;
- 適用光源: LED 24-36W
- 顏色: 深灰色

PRODUCTS CHARACTERS:

- Body: Made of high quality cast aluminum alloy with treatment of corrosion protection and UV-proof powder coating.
- Diffuser: Opal polycarbonate.
- Fastener: Made of stainless steel with high intensity and corrosion protection.
- Lamp: LED 24-36W
- Finish: Dark grey as standard. Matt coffee, matt black, dark bronze, matt grey any other RAL color is available upon request.

產品特點:

- 燈體材質: 優質鋁合金鑄造成型, 經防腐處理后, 采用防UV靜電粉未噴塗;
- 透光罩: 磨砂玻璃燈罩;
- 緊固件: 不鏽鋼材質, 强度高, 防腐蝕能力強;
- 適用光源: LED 24-36W
- 顏色: 深灰色

PRODUCTS CHARACTERS:

- Body: Made of high quality cast aluminum alloy with treatment of corrosion protection and UV-proof powder coating.
- Diffuser: Frosted glass.
- Fastener: Made of stainless steel with high intensity and corrosion protection.
- Lamp: LED 24-36W
- Finish: Dark grey as standard. Matt coffee, matt black, dark bronze, matt grey any other RAL color is available upon request.

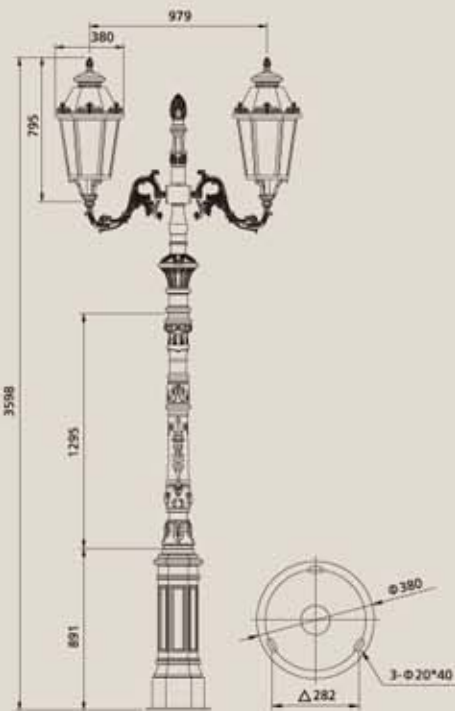

RHS-15637

產品特點:

- 燈體材質: 燈具鋁制品燈杆鐵制熱鍍鋅, 經防腐處理后, 采用防UV靜電粉未噴塗;
- 透光罩: 磨砂玻璃燈罩;
- 緊固件: 不鏽鋼材質, 强度高, 防腐蝕能力強;
- 適用光源: LED 24-36W
- 顏色: 沙黑色

PRODUCTS CHARACTERS:

- Body: Luminarie is made of high quality cast aluminum, light pole is made of hot-dip galvanized iron.
- Diffuser: Frosted glass.
- Fastener: Made of stainless steel with high intensity and corrosion protection.
- Lamp: LED 24-36W
- Finish: Dark grey as standard. Matt coffee, matt black, dark bronze, matt grey any other RAL color is available upon request.

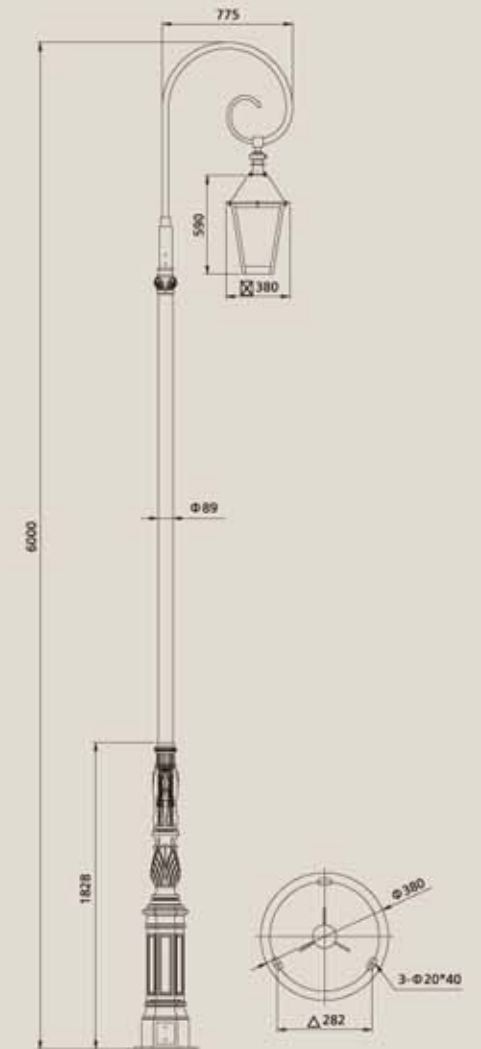

RHS-17344

產品特點:

- 燈體材質: 優質鋁合金鑄造型, 經防腐處理后, 采用防UV靜電粉末噴塗;
- 透光罩: PC奶白燈罩;
- 緊固件: 不鏽鋼材質, 强度高, 防腐蝕能力強;
- 適用光源: LED 15-24W
- 顏色: 沙黑色/深灰色

PRODUCTS CHARACTERS:

- Body: Made of high quality cast aluminum alloy with treatment of corrosion protection and UV-proof powder coating.
- Diffuser: Opal polycarbonate.
- Fastener: Made of stainless steel with high intensity and corrosion protection.
- Lamp: LED 15-24W
- Finish: Matt black as standard. Matt coffee, dark grey, dark bronze, matt grey any other RAL color is available upon request.

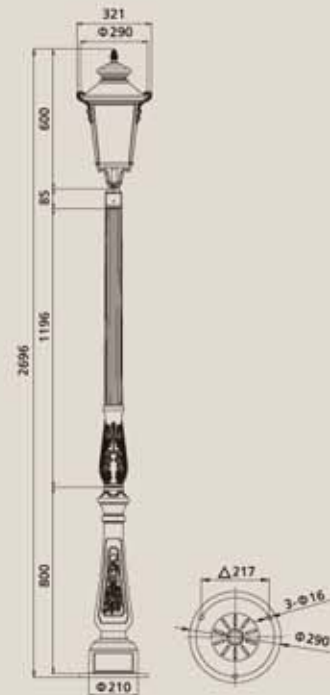

RHS-17345



RHS-17346

產品特點:

- 燈體材質: 優質鋁合金鑄造型, 經防腐處理后, 采用防UV靜電粉末噴塗;
- 透光罩: PC奶白燈罩;
- 緊固件: 不鏽鋼材質, 强度高, 防腐蝕能力強;
- 適用光源: LED 24-36W
- 顏色: 深灰色

PRODUCTS CHARACTERS:

- Body: Made of high quality cast aluminum alloy with treatment of corrosion protection and UV-proof powder coating.
- Diffuser: Opal polycarbonate.
- Fastener: Made of stainless steel with high intensity and corrosion protection.
- Lamp: LED 24-36W
- Finish: Matt black as standard. Matt coffee, dark grey, dark bronze, matt grey any other RAL color is available upon request.



RHS-15673

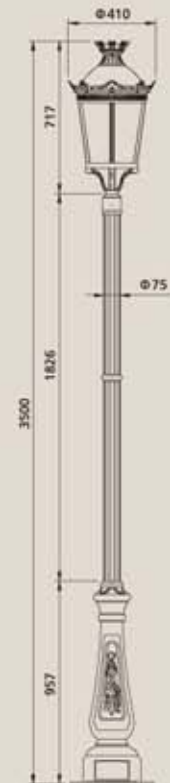
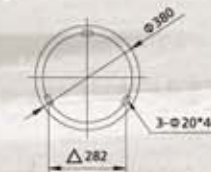

RHS-15667



產品特點:

- 燈體材質: 優質鋁合金鑄造成型, 經防腐處理后, 采用防UV靜電粉末噴塗;
- 透光罩: PC奶白燈罩;
- 緊固件: 不鏽鋼材質, 强度高, 防腐蝕能力強;
- 適用光源: LED 24-36W
- 顏色: 古銅色

PRODUCTS CHARACTERS:

- Body: Made of high quality cast aluminum alloy with treatment of corrosion protection and UV-proof powder coating.
- Diffuser: Opal polycarbonate.
- Fastener: Made of stainless steel with high intensity and corrosion protection.
- Lamp: LED 24-36W
- Finish: Dark grey as standard. Matt coffee, matt black, dark bronze, matt grey any other RAL color is available upon request.

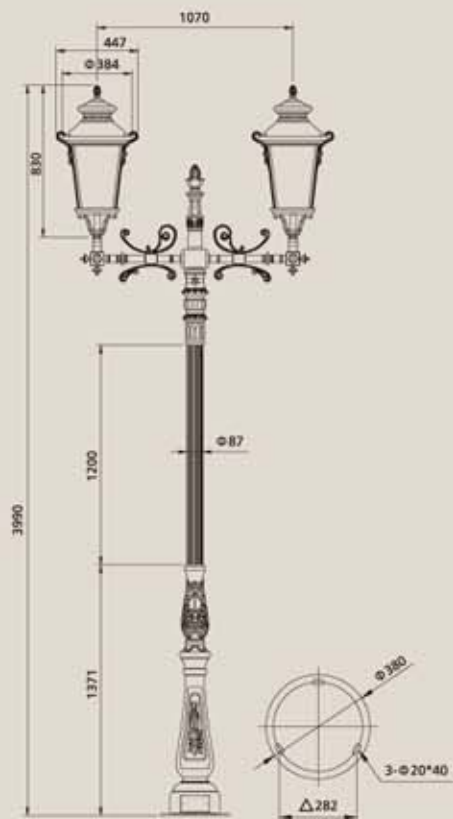

RHS-15675

產品特點:

- 燈體材質: 優質鋁合金鑄造成型, 經防腐處理后, 采用防UV靜電粉末噴塗;
- 透光罩: 奶白塑料燈罩;
- 緊固件: 不鏽鋼材質, 强度高, 防腐蝕能力強;
- 適用光源: LED 24-36W
- 顏色: 沙黑色

PRODUCTS CHARACTERS:

- Body: Made of high quality cast aluminum alloy with treatment of corrosion protection and UV-proof powder coating.
- Diffuser: Opal plastic.
- Fastener: Made of stainless steel with high intensity and corrosion protection.
- Lamp: LED 24-36W
- Finish: Matt black as standard. Matt coffee, dark grey, dark bronze, matt grey any other RAL color is available upon request.

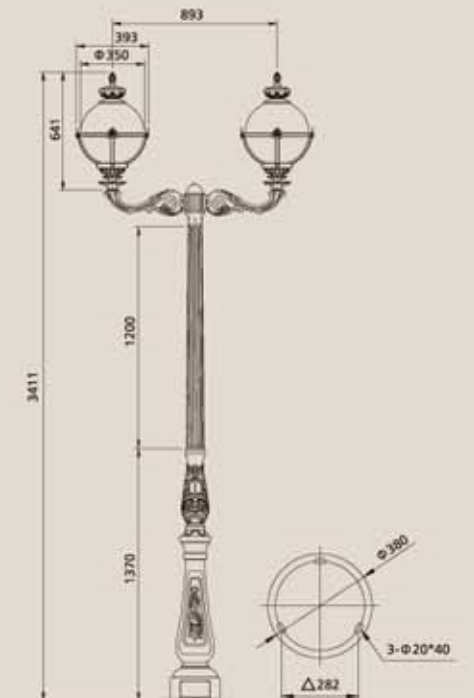

RHS-15679

產品特點:

- 燈體材質: 優質鋁合金鑄造成型, 經防腐處理后, 采用防UV靜電粉末噴塗;
- 透光罩: PC奶白燈罩;
- 緊固件: 不鏽鋼材質, 强度高, 防腐蝕能力強;
- 適用光源: LED 24-36W
- 顏色: 紅古銅色

PRODUCTS CHARACTERS:

- Body: Made of high quality cast aluminum alloy with treatment of corrosion protection and UV-proof powder coating.
- Diffuser: Opal polycarbonate.
- Fastener: Made of stainless steel with high intensity and corrosion protection.
- Lamp: LED 24-36W
- Finish: Red bronze as standard. Matt coffee, matt black, dark grey, matt grey any other RAL color is available upon request.

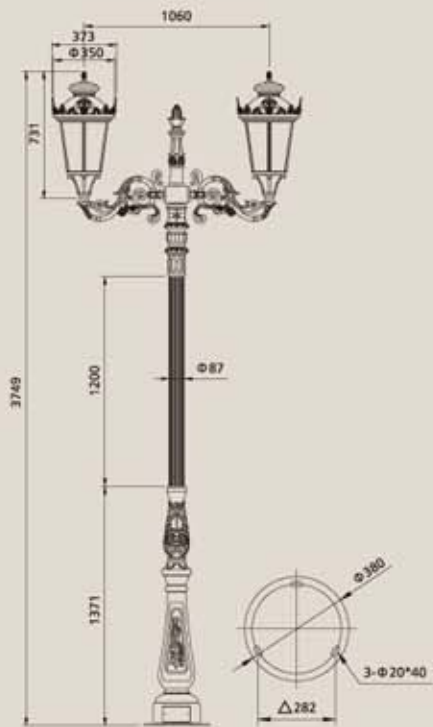

RHS-15676

產品特點:

- 燈體材質: 優質鋁合金鑄造成型, 經防腐處理后, 采用防UV靜電粉末噴塗;
- 透光罩: 磨砂玻璃燈罩/PC奶白燈罩;
- 緊固件: 不鏽鋼材質, 强度高, 防腐蝕能力強;
- 適用光源: LED 15-24W
- 顏色: 沙銀色/沙黑色

PRODUCTS CHARACTERS:

- Body: Made of high quality cast aluminum alloy with treatment of corrosion protection and UV-proof powder coating
- Diffuser: Frosted glass/Opal polycarbonate
- Fastener: Made of stainless steel with high intensity and corrosion protection
- Lamp: LED 15-24W
- Finish: Dark grey as standard. Matt coffee, Matt black, Dark bronze, Matt black any other RAL color is available upon request.



RHS-17347



RHS-17348

產品特點:

- 燈體材質: 優質鋁合金鑄造成型, 經防腐處理后, 采用防UV靜電粉末噴塗;
- 透光罩: PC奶白燈罩/透明玻璃燈罩;
- 反光器: 高純鋁反光器, 經陽極氧化處理;
- 緊固件: 不鏽鋼材質, 強度高, 防腐蝕能力強;
- 適用光源: LED 24-36W
- 顏色: 沙銀色/咖啡色

PRODUCTS CHARACTERS:

- Body: Made of high quality cast aluminum alloy with treatment of corrosion protection and UV-proof powder coating
- Diffuser: Opal polycarbonate/Clear glass
- Reflector: Made of anodized high pure aluminum
- Fastener: Made of stainless steel with high intensity and corrosion protection
- Lamp: LED 24-36W
- Finish: Matt coffee as standard. Dark grey, Matt grey, Dark bronze, Matt black any other RAL color is available upon request.



RHS-16444



RHS-16449

產品特點:

- 燈體材質: 優質鋁合金鑄造成型, 經防腐處理后, 采用防UV靜電粉末噴塗;
- 透光罩: PC奶白燈罩;
- 反光器: 高純鋁反光器, 經陽極氧化處理;
- 緊固件: 不鏽鋼材質, 強度高, 防腐蝕能力強;
- 適用光源: LED 15-24W
- 顏色: 沙黑色

PRODUCTS CHARACTERS:

- Body: Made of high quality cast aluminum alloy with treatment of corrosion protection and UV-proof powder coating
- Diffuser: Opal polycarbonate
- Reflector: Made of anodized high pure aluminum
- Fastener: Made of stainless steel with high intensity and corrosion protection
- Lamp: LED 15-24W
- Finish: Matt coffee as standard. Dark grey, Matt grey, Dark bronze, Matt black any other RAL color is available upon request.

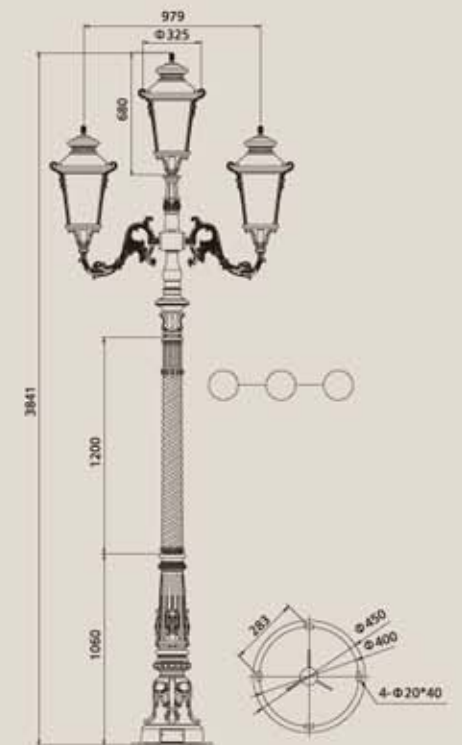

RHS-16455

產品特點:

- 燈體材質: 優質鋁合金鑄造成型, 經防腐處理后, 采用防UV靜電粉末噴塗;
- 透光罩: PC奶白燈罩;
- 緊固件: 不鏽鋼材質, 强度高, 防腐蝕能力強;
- 適用光源: LED 24-36W
- 顏色: 深灰色/沙銀色

PRODUCTS CHARACTERS:

- Body: Made of high quality cast aluminum alloy with treatment of corrosion protection and UV-proof powder coating
- Diffuser: Opal polycarbonate
- Fastener: Made of stainless steel with high intensity and corrosion protection
- Lamp: LED 24-36W
- Finish: Dark grey as standard. Matt coffee, Matt grey, Dark bronze, Matt black any other RAL color is available upon request.

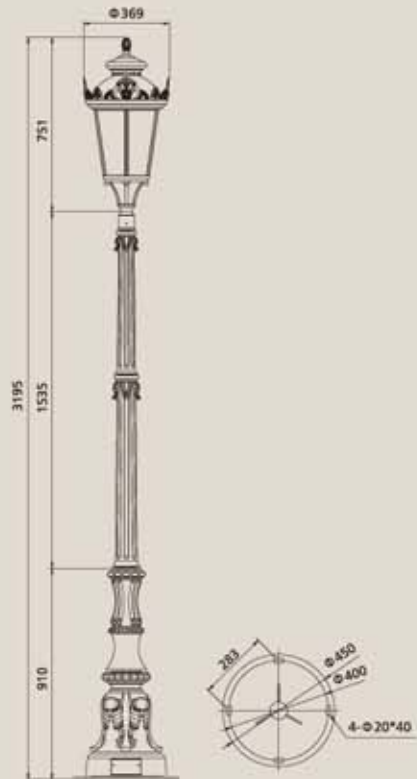

RHS-16453

RHS-17349

產品特點:

- 燈體材質: 優質鋁合金鑄造成型, 經防腐處理后, 采用防UV靜電粉末噴塗;
- 透光罩: PC奶白燈罩;
- 緊固件: 不鏽鋼材質, 强度高, 防腐蝕能力強;
- 適用光源: LED 15-24W
- 顏色: 沙黑色

PRODUCTS CHARACTERS:

- Body: Made of high quality cast aluminum alloy with treatment of corrosion protection and UV-proof powder coating
- Diffuser: Opal polycarbonate
- Fastener: Made of stainless steel with high intensity and corrosion protection
- Lamp: LED 15-24W
- Finish: Matt coffee as standard. Dark grey, Matt grey, Dark bronze, Matt black any other RAL color is available upon request.



RHS-17350

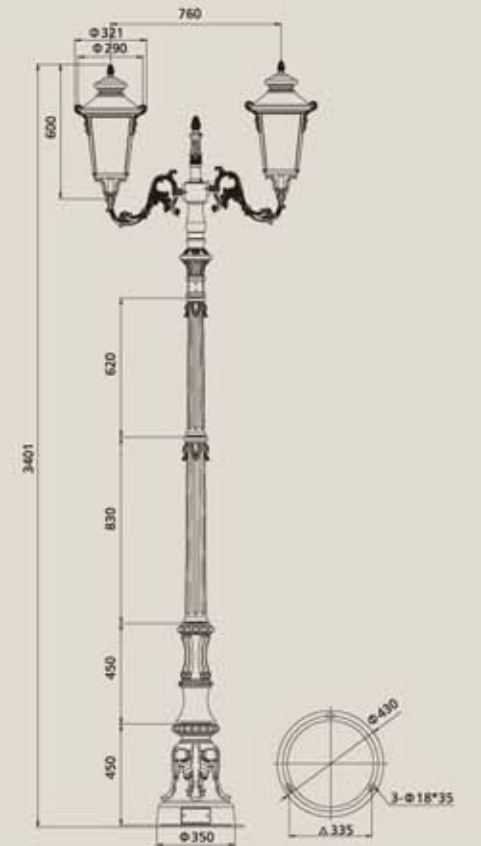

產品特點:

- 燈體材質: 優質鋁合金鑄造成型, 經防腐處理后, 采用防UV靜電粉末噴塗;
- 透光罩: PC奶白燈罩;
- 緊固件: 不鏽鋼材質, 强度高, 防腐蝕能力強;
- 適用光源: LED 15-24W
- 顏色: 深灰色

PRODUCTS CHARACTERS:

- Body: Made of high quality cast aluminum alloy with treatment of corrosion protection and UV-proof powder coating
- Diffuser: Opal polycarbonate
- Fastener: Made of stainless steel with high intensity and corrosion protection
- Lamp: LED 15-24W
- Finish: Dark grey as standard. Matt coffee, Matt grey, Dark bronze, Matt black any other RAL color is available upon request.

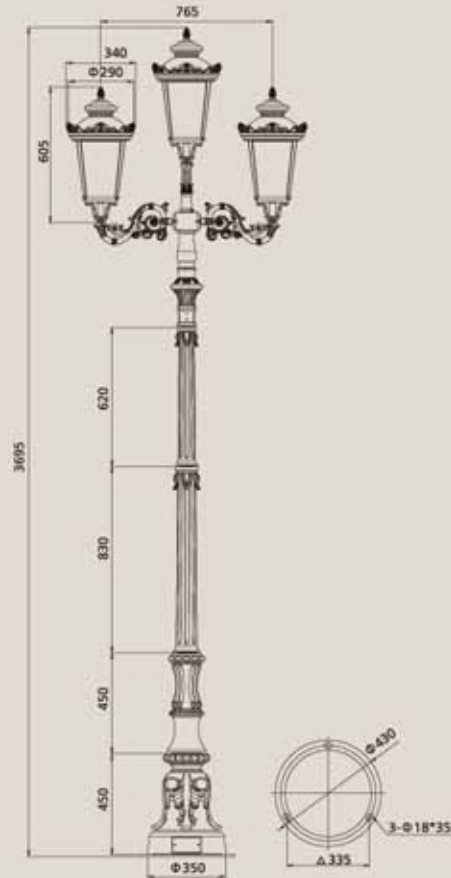

RHS-17351

產品特點:

- 燈體材質: 優質鋁合金鑄造成型, 經防腐處理后, 采用防UV靜電粉末噴塗;
- 透光罩: PC奶白燈罩;
- 緊固件: 不鏽鋼材質, 强度高, 防腐蝕能力強;
- 適用光源: LED 15-24W
- 顏色: 沙黑色

PRODUCTS CHARACTERS:

- Body: Made of high quality cast aluminum alloy with treatment of corrosion protection and UV-proof powder coating
- Diffuser: Opal polycarbonate
- Fastener: Made of stainless steel with high intensity and corrosion protection
- Lamp: LED 15-24W
- Finish: Matt black as standard. Dark grey, Matt grey, Dark bronze, Matt coffee any other RAL color is available upon request.

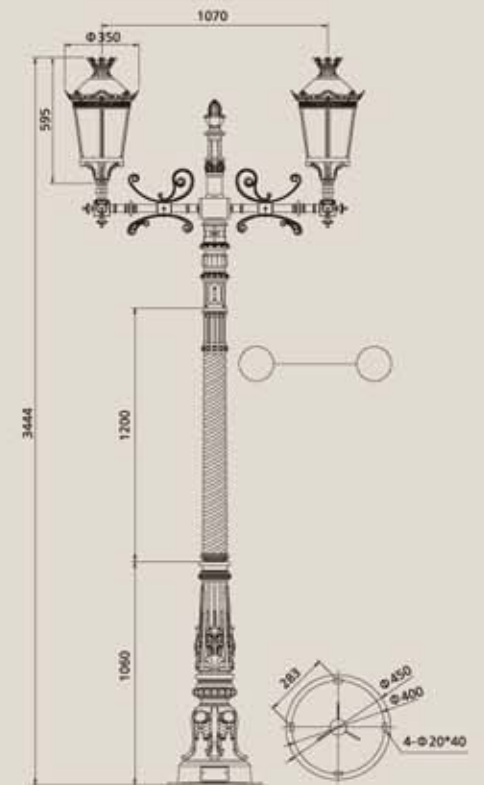

RHS-16457

產品特點:

- 燈體材質: 優質鋁合金鑄造成型, 經防腐處理后, 采用防UV靜電粉末噴塗;
- 透光罩: PC透明燈罩/磨砂玻璃燈罩;
- 緊固件: 不鏽鋼材質, 强度高, 防腐蝕能力強;
- 適用光源: LED 24-36W
- 顏色: 咖啡色/沙銀色

PRODUCTS CHARACTERS:

- Body: Made of high quality cast aluminum alloy with treatment of corrosion protection and UV-proof powder coating.
- Diffuser: Clear polycarbonate/frosted glass.
- Fastener: Made of stainless steel with high intensity and corrosion protection.
- Lamp: LED 24-36W
- Finish: Red bronze as standard. Matt coffee, matt black, dark grey, matt grey any other RAL color is available upon request.

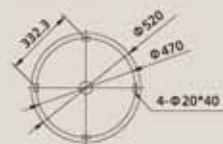

RHS-15558

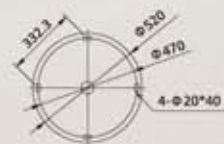

RHS-15560

產品特點:

- 燈體材質: 優質鋁合金鑄造成型, 經防腐處理后, 采用防UV靜電粉末噴塗;
- 透光罩: PC奶白燈罩/磨砂玻璃燈罩;
- 緊固件: 不鏽鋼材質, 强度高, 防腐蝕能力強;
- 適用光源: LED 15-24W
- 顏色: 沙黑色/深灰色

PRODUCTS CHARACTERS:

- Body: Made of high quality cast aluminum alloy with treatment of corrosion protection and UV-proof powder coating.
- Diffuser: Opal polycarbonate/frosted glass.
- Fastener: Made of stainless steel with high intensity and corrosion protection.
- Lamp: LED 15-24W
- Finish: Matt coffee as standard. Matt grey, dark grey, dark bronze, matt black any other RAL color is available upon request.



RHS-14215



RHS-17352



RHS-17353

產品特點:

- 燈體材質: 優質鋁合金鑄造成型, 經防腐處理后, 采用防UV靜電粉末噴塗;
- 透光罩: PC奶白燈罩;
- 緊固件: 不鏽鋼材質, 强度高, 防腐蝕能力強;
- 適用光源: LED 24-36W
- 顏色: 深灰色

PRODUCTS CHARACTERS:

- Body: Made of high quality cast aluminum alloy with treatment of corrosion protection and UV-proof powder coating.
- Diffuser: Opal polycarbonate/Opal plastic.
- Fastener: Made of stainless steel with high intensity and corrosion protection.
- Lamp: LED 24-36W
- Finish: Dark grey as standard. Matt coffee, matt black, dark bronze, matt grey any other RAL color is available upon request.

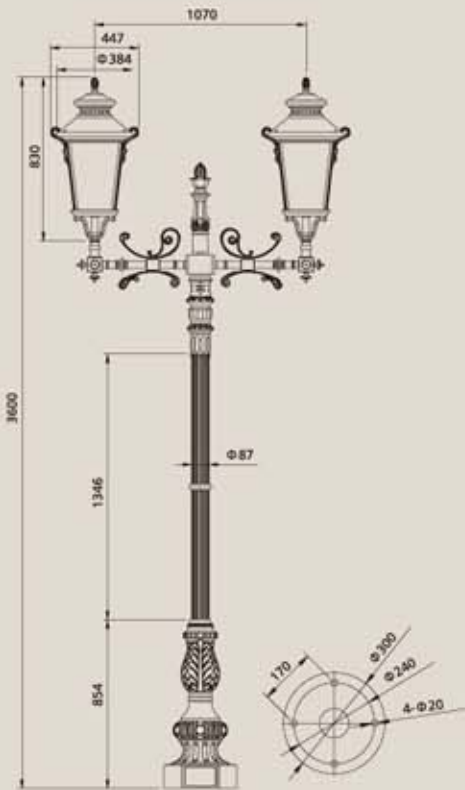

RHS-15644

產品特點:

- 燈體材質: 優質鋁合金鑄造成型, 經防腐處理后, 采用防UV靜電粉末噴塗;
- 透光罩: PC奶白燈罩/奶白塑料燈罩;
- 緊固件: 不鏽鋼材質, 强度高, 防腐蝕能力強;
- 適用光源: LED 24-36W
- 顏色: 深灰色

PRODUCTS CHARACTERS:

- Body: Made of high quality cast aluminum alloy with treatment of corrosion protection and UV-proof powder coating.
- Diffuser: Opal polycarbonate/Opal plastic.
- Fastener: Made of stainless steel with high intensity and corrosion protection.
- Lamp: LED 24-36W
- Finish: Dark grey as standard. Matt coffee, matt black, dark bronze, matt grey any other RAL color is available upon request.

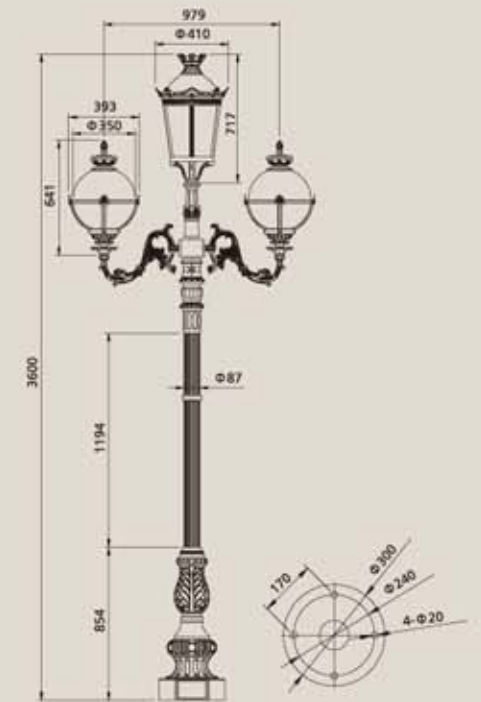

RHS-15645

產品特點:

- 燈體材質: 優質鋁合金鑄造成型, 經防腐處理后, 采用防UV靜電粉末噴塗;
- 透光罩: 磨砂玻璃燈罩/PC透明燈罩;
- 緊固件: 不鏽鋼材質, 强度高, 防腐蝕能力強;
- 適用光源: LED 24-36W
- 顏色: 咖啡色

PRODUCTS CHARACTERS:

- Body: Made of high quality cast aluminum alloy with treatment of corrosion protection and UV-proof powder coating.
- Diffuser: Frosted glass/Clear polycarbonate.
- Fastener: Made of stainless steel with high intensity and corrosion protection.
- Lamp: LED 24-36W
- Finish: Matt coffee as standard. Matt grey, dark grey, dark bronze, matt black any other RAL color is available upon request.

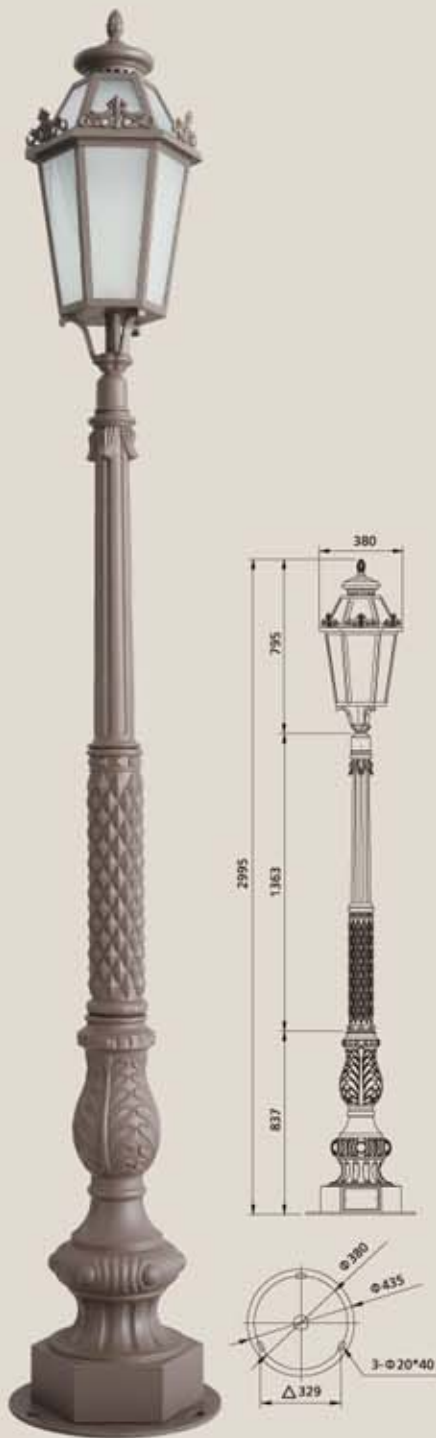

RHS-15650



RHS-15651

產品特點:

- 燈體材質: 優質鋁合金鑄造成型, 經防腐處理后, 采用防UV靜電粉末噴塗;
- 透光罩: PC透明燈罩/PC奶白燈罩;
- 緊固件: 不鏽鋼材質, 强度高, 防腐蝕能力強;
- 適用光源: LED 24-36W
- 顏色: 咖啡色/沙銀色

PRODUCTS CHARACTERS:

- Body: Made of high quality cast aluminum alloy with treatment of corrosion protection and UV-proof powder coating.
- Diffuser: Clear polycarbonate/Opal polycarbonate.
- Fastener: Made of stainless steel with high intensity and corrosion protection.
- Lamp: LED 24-36W
- Finish: Matt coffee as standard. Matt grey, dark grey, dark bronze, matt black any other RAL color is available upon request.



RHS-15655



RHS-15657

產品特點:

- 燈體材質: 優質鋁合金鑄造成型, 經防腐處理后, 采用防UV靜電粉末噴塗;
- 透光罩: PC奶白燈罩;
- 緊固件: 不鏽鋼材質, 强度高, 防腐蝕能力強;
- 適用光源: LED 24-36W
- 顏色: 古銅色

PRODUCTS CHARACTERS:

- Body: Made of high quality cast aluminum alloy with treatment of corrosion protection and UV-proof powder coating.
- Diffuser: Opal polycarbonate.
- Fastener: Made of stainless steel with high intensity and corrosion protection.
- Lamp: LED 24-36W
- Finish: Dark bronze as standard. Matt coffee, matt black, dark grey, matt grey any other RAL color is available upon request.

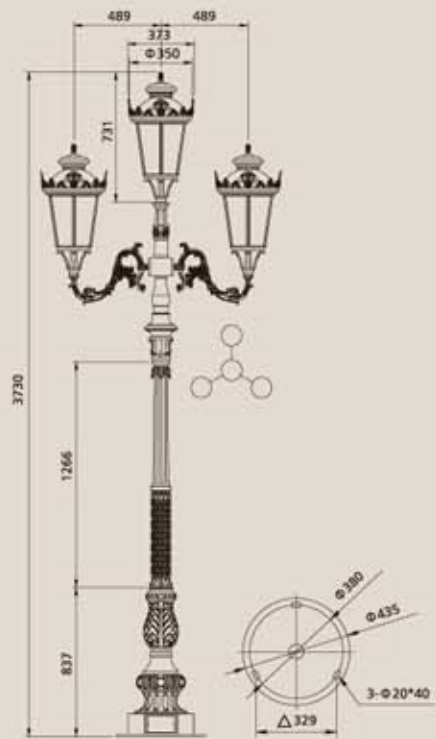

RHS-15653

產品特點:

- 燈體材質: 優質鋁合金鑄造成型, 經防腐處理后, 采用防UV靜電粉末噴塗;
- 透光罩: PC奶白燈罩/PC透明燈罩;
- 反光器: 高純鋁反光器, 經陽極氧化處理;
- 緊固件: 不鏽鋼材質, 强度高, 防腐蝕能力強;
- 適用光源: LED 24-36W
- 顏色: 深灰色/沙銀色

PRODUCTS CHARACTERS:

- Body: Made of high quality cast aluminum alloy with treatment of corrosion protection and UV-proof powder coating.
- Diffuser: Opal polycarbonate/Clear polycarbonate.
- Reflector: Made of anodized high pure aluminum.
- Fastener: Made of stainless steel with high intensity and corrosion protection.
- Lamp: LED 24-36W
- Finish: Matt grey as standard. Matt coffee, dark grey, dark bronze, matt black any other RAL color is available upon request.

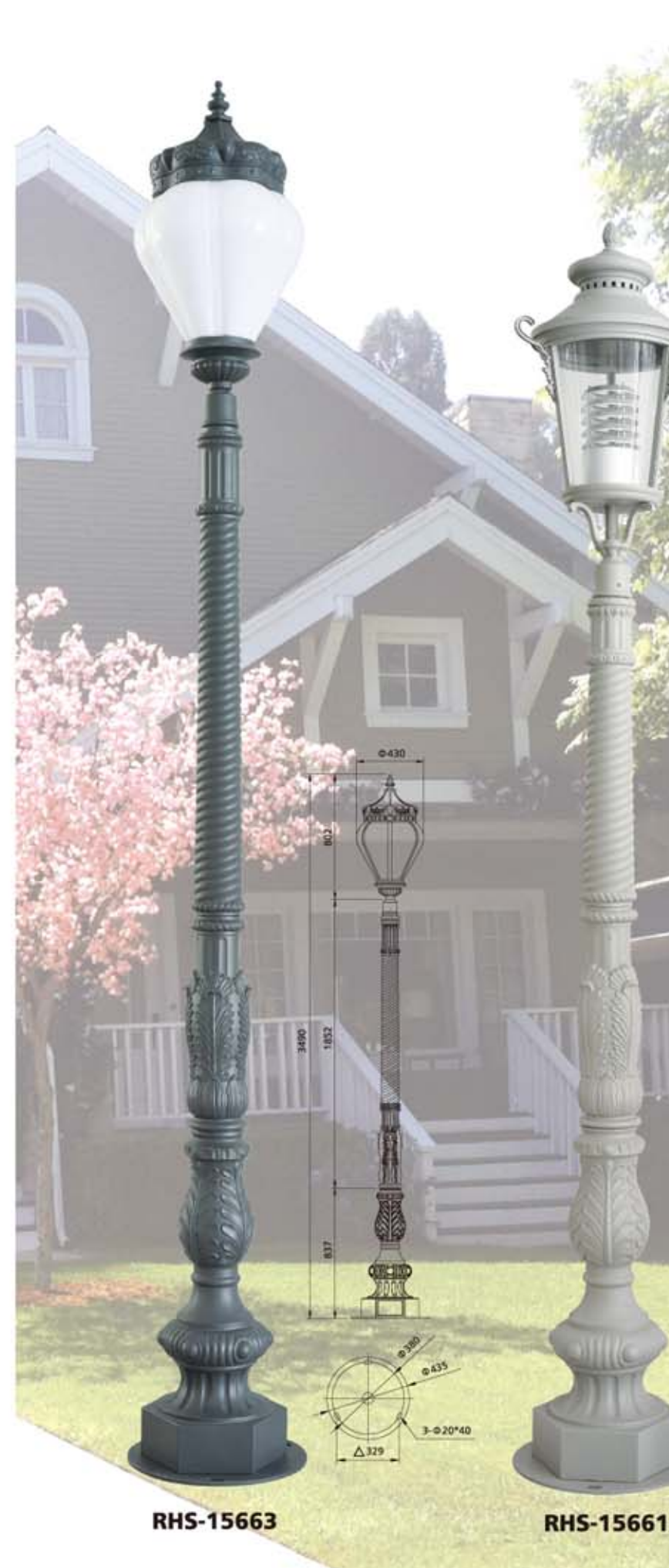

RHS-15663

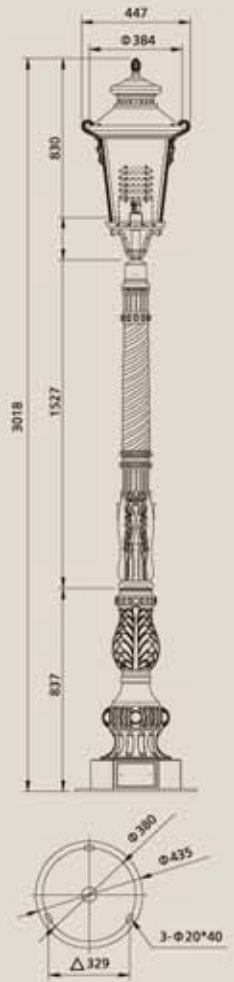

RHS-15661

產品特點:

- 燈體材質: 優質鋁合金鑄造成型, 經防腐處理后, 采用防UV靜電粉末噴塗;
- 透光罩: 磨砂玻璃燈罩;
- 緊固件: 不鏽鋼材質, 强度高, 防腐蝕能力強;
- 適用光源: LED 15-24W
- 顏色: 深灰色

PRODUCTS CHARACTERS:

- Body: Made of high quality cast aluminum alloy with treatment of corrosion protection and UV-proof powder coating.
- Diffuser: Frosted glass.
- Fastener: Made of stainless steel with high intensity and corrosion protection.
- Lamp: LED 15-24W
- Finish: Dark grey as standard. Matt coffee, matt black, dark bronze, matt grey any other RAL color is available upon request.



RHS-17354



RHS-17355



RHS-14241

產品特點:

- 燈體材質: 優質鋁合金鑄造成型, 經防腐處理后, 采用防UV靜電粉末噴塗;
- 透光罩: PC奶白燈罩;
- 緊固件: 不鏽鋼材質, 强度高, 防腐蝕能力強;
- 適用光源: LED 15-24W
- 顏色: 沙黑色

PRODUCTS CHARACTERS:

- Body: Made of high quality cast aluminum alloy with treatment of corrosion protection and UV-proof powder coating.
- Diffuser: Opal polycarbonate.
- Fastener: Made of stainless steel with high intensity and corrosion protection.
- Lamp: LED 15-24W
- Finish: Dark grey as standard. Matt coffee, matt black, dark bronze, matt grey any other RAL color is available upon request.

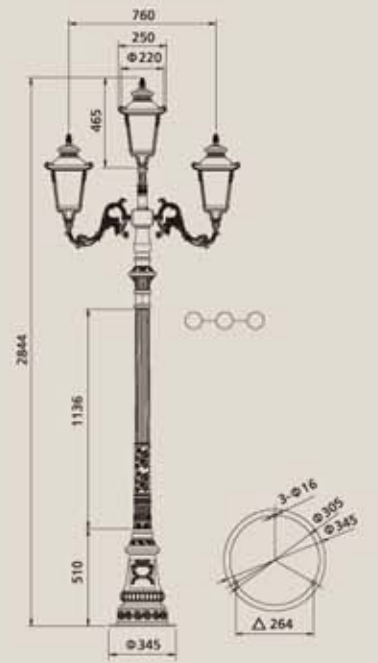

產品特點:

- 燈體材質: 優質鋁合金鑄造成型, 經防腐處理后, 采用防UV靜電粉末噴塗;
- 透光罩: 奶白塑料燈罩/PC奶白燈罩;
- 緊固件: 不鏽鋼材質, 强度高, 防腐蝕能力強;
- 適用光源: LED 24-36W
- 顏色: 古銅色/紅古銅色

PRODUCTS CHARACTERS:

- Body: Made of high quality cast aluminum alloy with treatment of corrosion protection and UV-proof powder coating.
- Diffuser: Opal plastic/Opal polycarbonate.
- Fastener: Made of stainless steel with high intensity and corrosion protection.
- Lamp: LED 24-36W
- Finish: Red bronze as standard. Matt coffee, matt black, dark grey, matt grey any other RAL color is available upon request.



RHS-14284

RHS-14283

產品特點:

- 燈體材質: 優質鋁鎂製品, 經防腐處理后, 采用防UV靜電粉末噴塗;
- 透光罩: PC奶白燈罩;
- 緊固件: 不鏽鋼材質, 强度高, 防腐蝕能力強;
- 適用光源: LED 36-45W
- 顏色: 沙銀色/沙黑色

PRODUCTS CHARACTERS:

- Body: Made of high quality cast aluminum and iron alloy with treatment of corrosion protection and UV-proof powder coating.
- Diffuser: Opal polycarbonate.
- Fastener: Made of stainless steel with high intensity and corrosion protection.
- Lamp: LED 36-45W
- Finish: Matt black as standard. Matt coffee, dark grey, dark bronze, matt grey any other RAL color is available upon request.



RHS-14281

RHS-14295

產品特點:

- 燈體材質: 優質鋁合金鑄造成型, 經防腐處理后, 采用防UV靜電粉末噴塗;
- 透光罩: 磨砂玻璃燈罩/PC奶白燈罩;
- 緊固件: 不鏽鋼材質, 强度高, 防腐蝕能力強;
- 適用光源: LED 15-24W
- 顏色: 沙銀色/深灰色

PRODUCTS CHARACTERS:

- Body: Made of high quality cast aluminum alloy with treatment of corrosion protection and UV-proof powder coating.
- Diffuser: Frosted glass/Opal polycarbonate.
- Fastener: Made of stainless steel with high intensity and corrosion protection.
- Lamp: LED 15-24W
- Finish: Dark grey as standard. Matt coffee, matt black, dark bronze, matt grey any other RAL color is available upon request.

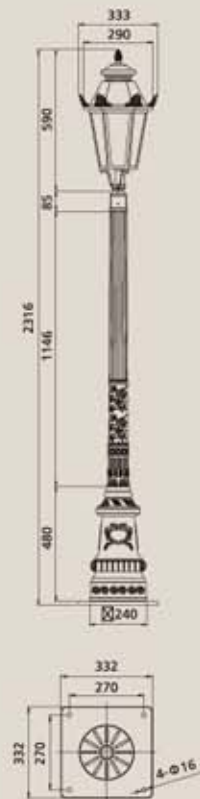

RHS-17356

RHS-17357



RHS-14264

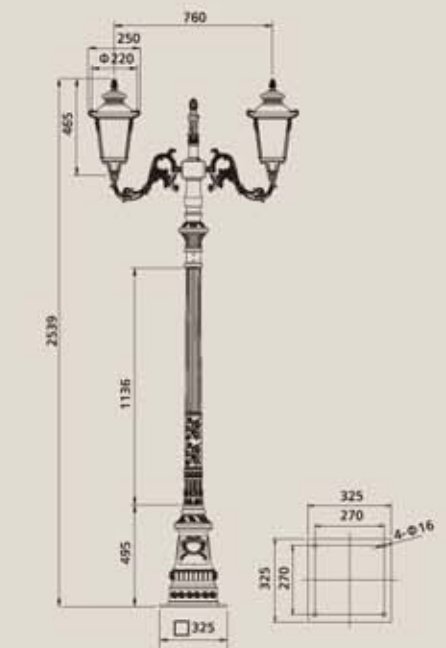

產品特點:

- 燈體材質: 優質鋁合金鑄造成型, 經防腐處理后, 采用防UV靜電粉末噴塗;
- 透光罩: PC奶白燈罩;
- 緊固件: 不鏽鋼材質, 强度高, 防腐蝕能力強;
- 適用光源: LED 15-24W
- 顏色: 深灰色

PRODUCTS CHARACTERS:

- Body: Made of high quality cast aluminum alloy with treatment of corrosion protection and UV-proof powder coating.
- Diffuser: Opal polycarbonate.
- Fastener: Made of stainless steel with high intensity and corrosion protection.
- Lamp: LED 15-24W
- Finish: Dark grey as standard. Matt coffee, matt black, dark bronze, matt grey any other RAL color is available upon request.

產品特點:

- 燈體材質: 優質鋁製品, 經防腐處理后, 采用防UV靜電粉末噴塗;
- 透光罩: 磨砂玻璃燈罩;
- 緊固件: 不鏽鋼材質, 强度高, 防腐蝕能力強;
- 適用光源: LED 36-45W
- 顏色: 咖啡色

PRODUCTS CHARACTERS:

- Body: Made of high quality cast aluminum and iron alloy with treatment of corrosion protection and UV-proof powder coating.
- Diffuser: Frosted glass.
- Fastener: Made of stainless steel with high intensity and corrosion protection.
- Lamp: LED 36-45W
- Finish: Matt black as standard. Matt coffee, dark grey, dark bronze, matt grey any other RAL color is available upon request.

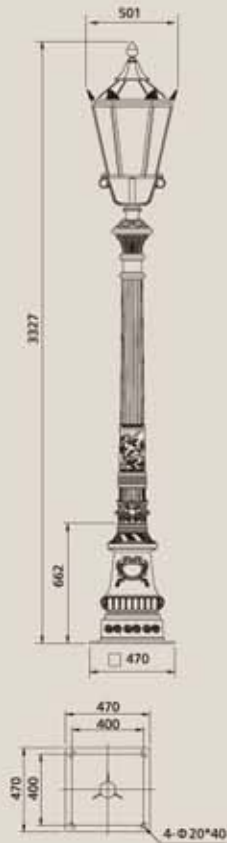

RHS-14302



RHS-14307



產品特點:

- 燈體材質: 優質鋁合金鑄造型, 經防腐處理后, 采用防UV靜電粉末噴塗;
- 透光罩: PC磨砂燈罩/PC奶白燈罩/奶白塑料燈罩;
- 緊固件: 不鏽鋼材質, 强度高, 防腐蝕能力強;
- 適用光源: LED 24-36W
- 顏色: 咖啡色/沙銀色

PRODUCTS CHARACTERS:

- Body: Made of high quality cast aluminum alloy with treatment of corrosion protection and UV-proof powder coating.
- Diffuser: Frosted polycarbonate/Opal polycarbonate/Opal plastic.
- Fastener: Made of stainless steel with high intensity and corrosion protection.
- Lamp: LED 24-36W
- Finish: Matt coffee as standard. Matt grey, dark grey, dark bronze, matt black any other RAL color is available upon request.



RHS-14297



RHS-14300

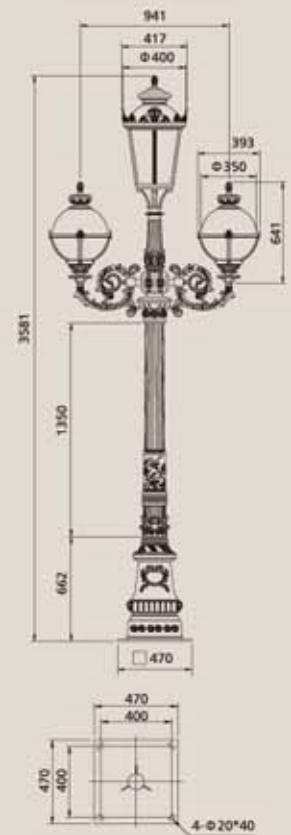

產品特點:

- 燈體材質: 優質鋁製品, 經防腐處理后, 采用防UV靜電粉末噴塗;
- 透光罩: PC奶白燈罩;
- 緊固件: 不鏽鋼材質, 强度高, 防腐蝕能力強;
- 適用光源: LED 24-36W
- 顏色: 沙黑色

PRODUCTS CHARACTERS:

- Body: Made of high quality cast aluminum and iron alloy with treatment of corrosion protection and UV-proof powder coating.
- Diffuser: Opal polycarbonate.
- Fastener: Made of stainless steel with high intensity and corrosion protection.
- Lamp: LED 24-36W
- Finish: Matt black as standard. Matt coffee, dark grey, dark bronze, matt grey any other RAL color is available upon request.

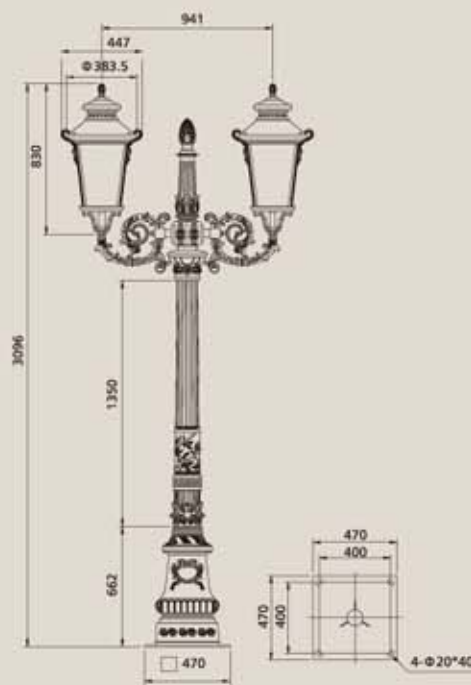

RHS-14301

產品特點:

- 燈體材質: 優質鋁合金鑄造成型, 經防腐處理后, 采用防UV靜電粉末噴塗;
- 透光罩: PC奶白燈罩/磨砂玻璃燈罩;
- 緊固件: 不鏽鋼材質, 强度高, 防腐蝕能力強;
- 適用光源: LED 15-24W
- 顏色: 沙黑色/深灰色

PRODUCTS CHARACTERS:

- Body: Made of high quality cast aluminum alloy with treatment of corrosion protection and UV-proof powder coating.
- Diffuser: Opal polycarbonate/frosted glass.
- Fastener: Made of stainless steel with high intensity and corrosion protection.
- Lamp: LED 15-24W
- Finish: Matt grey/matt black/matt coffee, as standard. Dark grey, dark bronze any other RAL color is available upon request.

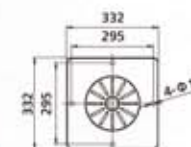

RHS-17358

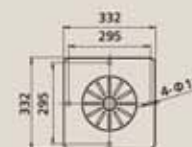
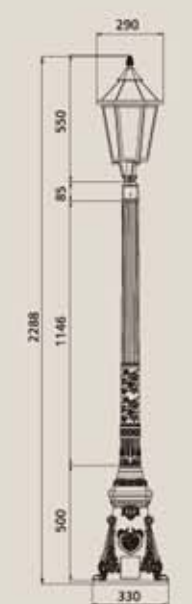

RHS-17359

產品特點:

- 燈體材質: 優質鋁合金鑄造成型, 經防腐處理后, 采用防UV靜電粉末噴塗;
- 透光罩: PC磨砂燈罩/磨砂玻璃燈罩;
- 緊固件: 不鏽鋼材質, 强度高, 防腐蝕能力強;
- 適用光源: LED 15-24W
- 顏色: 咖啡色/深灰色

PRODUCTS CHARACTERS:

- Body: Made of high quality cast aluminum alloy with treatment of corrosion protection and UV-proof powder coating.
- Diffuser: Frosted polycarbonate/frosted glass.
- Fastener: Made of stainless steel with high intensity and corrosion protection.
- Lamp: LED 15-24W
- Finish: Matt grey/matt black/matt coffee, as standard. Dark grey, dark bronze any other RAL color is available upon request.



RHS-15705



RHS-17360

產品特點:

- 燈體材質: 優質鋁合金鑄造成型, 經防腐處理后, 采用防UV靜電粉末噴塗;
- 透光罩: PC奶白燈罩;
- 緊固件: 不鏽鋼材質, 强度高, 防腐蝕能力強;
- 適用光源: LED 24-36W
- 顏色: 沙銀色/深灰色

PRODUCTS CHARACTERS:

- Body: Made of high quality cast aluminum alloy with treatment of corrosion protection and UV-proof powder coating.
- Diffuser: Opal polycarbonate.
- Fastener: Made of stainless steel with high intensity and corrosion protection.
- Lamp: LED 24-36W
- Finish: Matt grey as standard. Matt coffee, dark grey, dark bronze, matt black any other RAL color is available upon request.



RHS-14318



RHS-14315

產品特點:

- 燈體材質: 優質鋁合金鑄造成型, 經防腐處理后, 采用防UV靜電粉末噴塗;
- 透光罩: PC奶白燈罩、奶白塑料燈罩;
- 緊固件: 不鏽鋼材質, 强度高, 防腐蝕能力強;
- 適用光源: LED 15-24W
- 顏色: 古銅色

PRODUCTS CHARACTERS:

- Body: Made of high quality cast aluminum alloy with treatment of corrosion protection and UV-proof powder coating.
- Diffuser: Opal polycarbonate, Opal plastic.
- Fastener: Made of stainless steel with high intensity and corrosion protection.
- Lamp: LED 15-24W
- Finish: Dark bronze as standard. Matt coffee, matt black, dark grey, matt grey any other RAL color is available upon request.

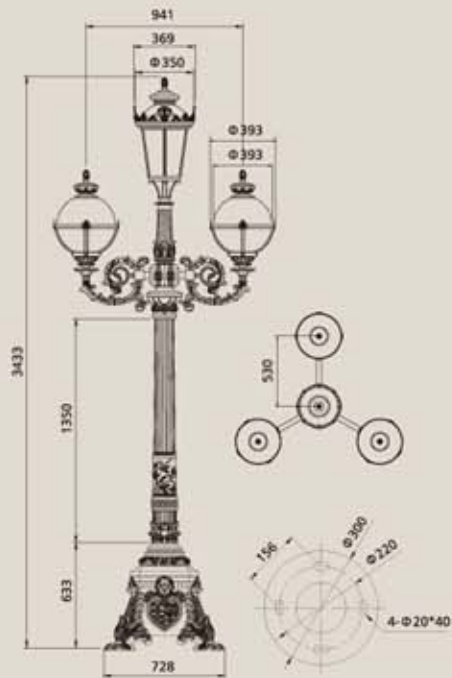

RHS-14322

產品特點:

- 燈體材質: 優質鋁合金鑄造成型, 經防腐處理后, 采用防UV靜電粉末噴塗;
- 透光罩: PC奶白燈罩、奶白塑料燈罩;
- 緊固件: 不鏽鋼材質, 强度高, 防腐蝕能力強;
- 適用光源: LED 15-24W
- 顏色: 古銅色

PRODUCTS CHARACTERS:

- Body: Made of high quality cast aluminum alloy with treatment of corrosion protection and UV-proof powder coating.
- Diffuser: Opal polycarbonate, Opal plastic.
- Fastener: Made of stainless steel with high intensity and corrosion protection.
- Lamp: LED 15-24W
- Finish: Dark bronze as standard. Matt coffee, matt black, dark grey, matt grey any other RAL color is available upon request.

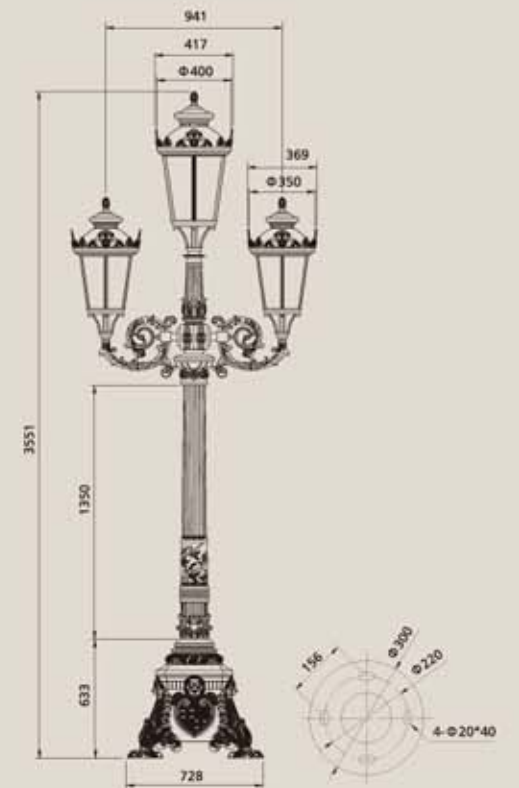

RHS-14324

產品特點:

- 燈體材質: 優質鋁合金鑄造型, 經防腐處理后, 采用防UV靜電粉末噴塗;
- 透光罩: PC奶白燈罩;
- 緊固件: 不鏽鋼材質, 强度高, 防腐蝕能力強;
- 適用光源: LED 24-36W
- 顏色: 沙黑色/咖啡色

PRODUCTS CHARACTERS:

- Body: Made of high quality cast aluminum alloy with treatment of corrosion protection and UV-proof powder coating.
- Diffuser: Opal polycarbonate.
- Fastener: Made of stainless steel with high intensity and corrosion protection.
- Lamp: LED 24-36W
- Finish: Matt coffee as standard. Matt grey, dark grey, dark bronze, matt black any other RAL color is available upon request.



RHS-14323

RHS-14326

產品特點:

- 燈體材質: 優質鋁合金鑄造型, 經防腐處理后, 采用防UV靜電粉末噴塗;
- 透光罩: PC磨砂燈罩/磨砂玻璃燈罩;
- 緊固件: 不鏽鋼材質, 强度高, 防腐蝕能力強;
- 適用光源: LED 24-36W
- 顏色: 咖啡色/深灰色

PRODUCTS CHARACTERS:

- Body: Made of high quality cast aluminum alloy with treatment of corrosion protection and UV-proof powder coating.
- Diffuser: Frosted polycarbonate/Frosted glass.
- Fastener: Made of stainless steel with high intensity and corrosion protection.
- Lamp: LED 24-36W
- Finish: Matt grey as standard. Matt coffee, dark grey, dark bronze, matt black any other RAL color is available upon request.



RHS-15435

RHS-15451

RHS-15428

產品特點:

- 燈體材質: 優質鋁合金鑄造型, 經防腐處理后, 采用防UV靜電粉末噴塗;
- 透光罩: PC磨砂燈罩;
- 緊固件: 不鏽鋼材質, 强度高, 防腐蝕能力強;
- 適用光源: LED 15-24W
- 顏色: 沙銀色

PRODUCTS CHARACTERS:

- Body: Made of high quality cast aluminum alloy with treatment of corrosion protection and UV-proof powder coating.
- Diffuser: Frosted polycarbonate.
- Fastener: Made of stainless steel with high intensity and corrosion protection.
- Lamp: LED 15-24W
- Finish: Matt grey as standard. Matt coffee, dark grey, dark bronze, matt black any other RAL color is available upon request.

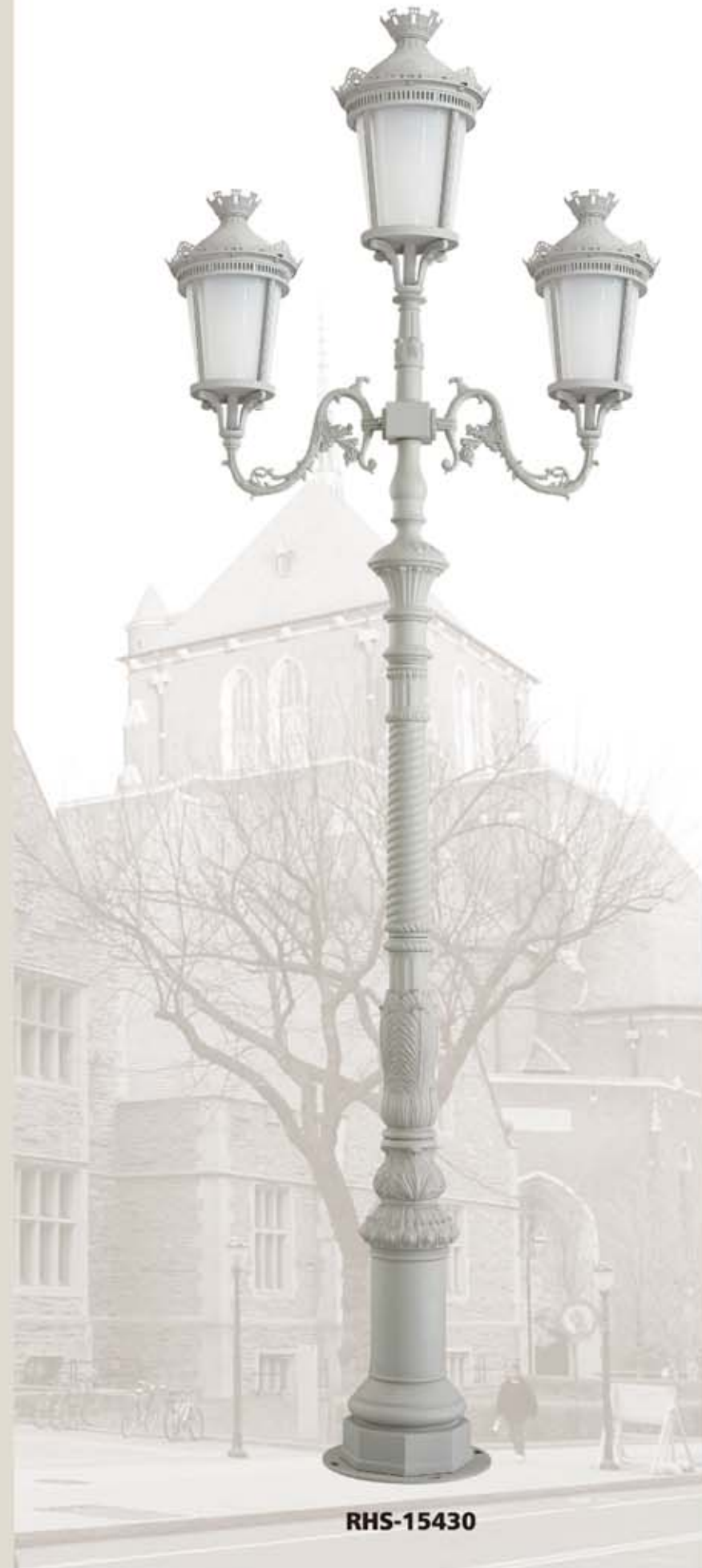
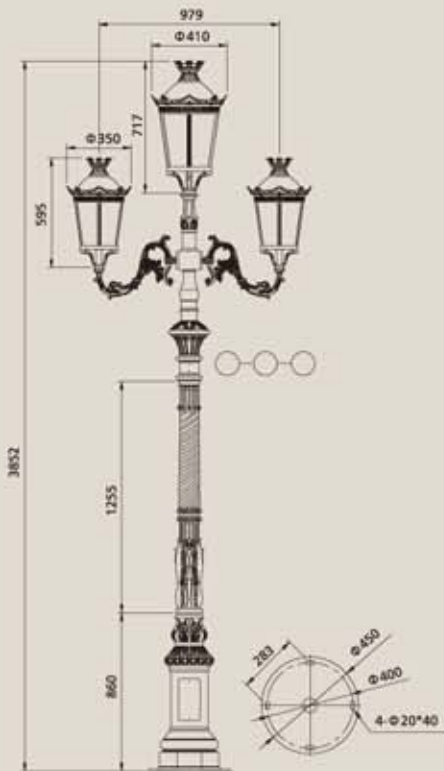

RHS-15430

產品特點:

- 燈體材質: 優質鋁合金鑄造型, 經防腐處理后, 采用防UV靜電粉末噴塗;
- 透光罩: PC奶白燈罩;
- 緊固件: 不鏽鋼材質, 强度高, 防腐蝕能力強;
- 適用光源: LED 24-36W
- 顏色: 沙黑色

PRODUCTS CHARACTERS:

- Body: Made of high quality cast aluminum alloy with treatment of corrosion protection and UV-proof powder coating.
- Diffuser: Opal polycarbonate.
- Fastener: Made of stainless steel with high intensity and corrosion protection.
- Lamp: LED 24-36W
- Finish: Matt black as standard. Matt coffee, dark grey, dark bronze, matt grey any other RAL color is available upon request.

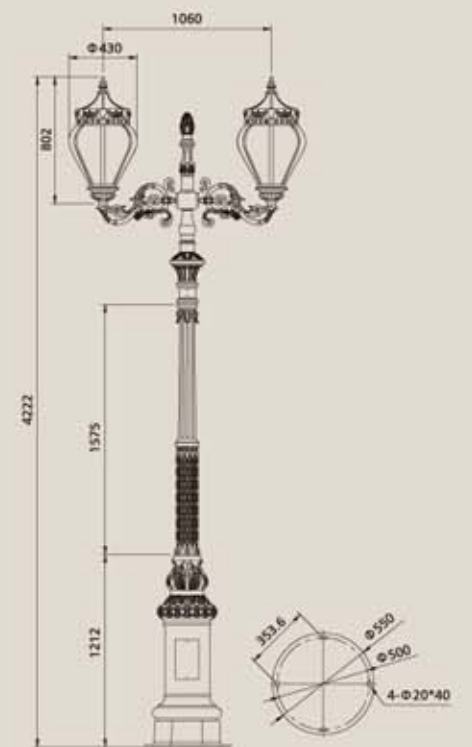

RHS-15415

產品特點:

- 燈體材質: 優質鋁合金鑄造成型, 經防腐處理后, 采用防UV靜電粉末噴塗;
- 透光罩: 透明玻璃燈罩;
- 緊固件: 不鏽鋼材質, 强度高, 防腐蝕能力強;
- 適用光源: LED 24-36W
- 顏色: 沙銀色

PRODUCTS CHARACTERS:

- Body: Made of high quality cast aluminum alloy with treatment of corrosion protection and UV-proof powder coating.
- Diffuser: Clear glass.
- Fastener: Made of stainless steel with high intensity and corrosion protection.
- Lamp: LED 24-36W
- Finish: Matt grey as standard, dark grey, dark bronze, matt black any other RAL color is available upon request.

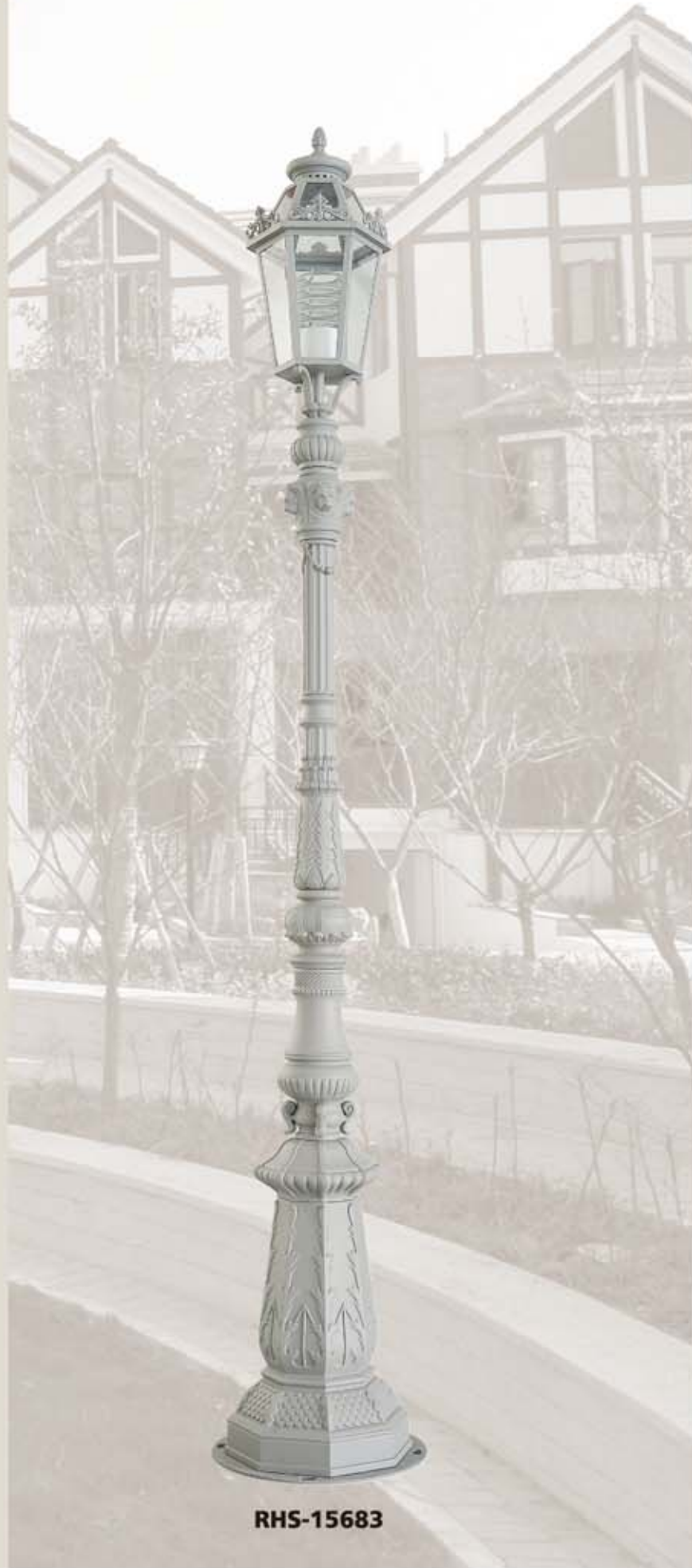
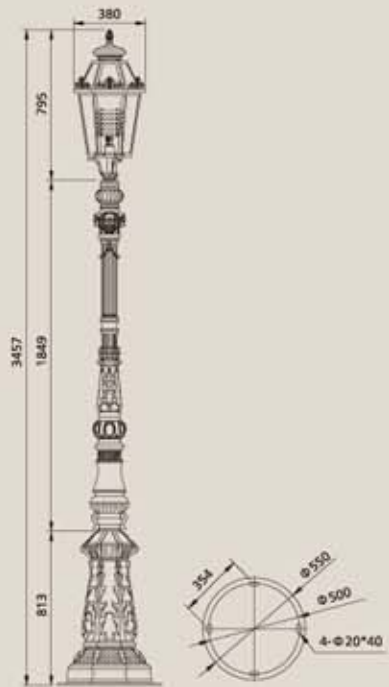

RHS-15683

產品特點:

- 燈體材質: 優質鋁合金鑄造成型, 經防腐處理后, 采用防UV靜電粉末噴塗;
- 透光罩: 磨砂玻璃燈罩/PC奶白燈罩;
- 緊固件: 不鏽鋼材質, 强度高, 防腐蝕能力強;
- 適用光源: LED 15-24W
- 顏色: 深灰色/沙黑色

PRODUCTS CHARACTERS:

- Body: Made of high quality cast aluminum alloy with treatment of corrosion protection and UV-proof powder coating.
- Diffuser: Frosted glass/Opal polycarbonate.
- Fastener: Made of stainless steel with high intensity and corrosion protection.
- Lamp: LED 15-24W
- Finish: Matt grey as standard, dark grey, dark bronze, matt black any other RAL color is available upon request.



RHS-17361

RHS-17362

RHS-17363

產品特點:

- 燈體材質: 優質鋁合金鑄造成型, 經防腐處理后, 采用防UV靜電粉末噴塗;
- 透光罩: 磨砂玻璃燈罩;
- 緊固件: 不鏽鋼材質, 强度高, 防腐蝕能力強;
- 適用光源: LED 24-36W
- 顏色: 咖啡色

PRODUCTS CHARACTERS:

- Body: Made of high quality cast aluminum alloy with treatment of corrosion protection and UV-proof powder coating.
- Diffuser: Frosted glass.
- Fastener: Made of stainless steel with high intensity and corrosion protection.
- Lamp: LED 24-36W
- Finish: Matt coffee as standard. Matt grey, dark grey, dark bronze, matt black any other RAL color is available upon request.

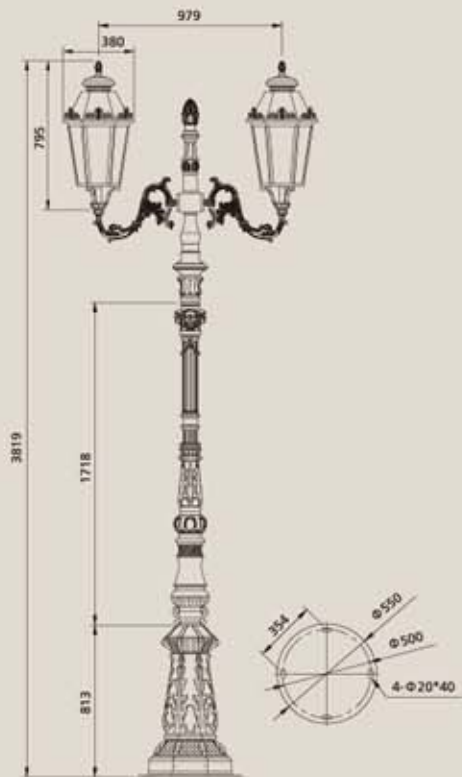

RHS-15682

產品特點:

- 燈體材質: 優質鋁合金鑄造成型, 經防腐處理后, 采用防UV靜電粉末噴塗;
- 透光罩: PC奶白燈罩/PC透明燈罩;
- 緊固件: 不鏽鋼材質, 强度高, 防腐蝕能力強;
- 適用光源: LED 24-36W
- 顏色: 沙黑色/沙銀色

PRODUCTS CHARACTERS:

- Body: Made of high quality cast aluminum alloy with treatment of corrosion protection and UV-proof powder coating.
- Diffuser: Opal polycarbonate/Clear polycarbonate.
- Fastener: Made of stainless steel with high intensity and corrosion protection.
- Lamp: LED 24-36W
- Finish: Dark grey as standard. Matt coffee, matt black, dark bronze, matt grey any other RAL color is available upon request.

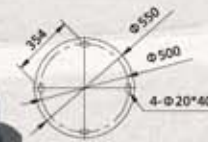

RHS-15690

RHS-15687

產品特點:

- 燈體材質: 優質鋁合金鑄造型, 經防腐處理后, 采用防UV靜電粉末噴塗;
- 透光罩: PC奶白燈罩;
- 緊固件: 不鏽鋼材質, 强度高, 防腐蝕能力強;
- 適用光源: LED 24-36W
- 顏色: 深灰色

PRODUCTS CHARACTERS:

- Body: Made of high quality cast aluminum alloy with treatment of corrosion protection and UV-proof powder coating.
- Diffuser: Opal polycarbonate.
- Fastener: Made of stainless steel with high intensity and corrosion protection.
- Lamp: LED 24-36W
- Finish: Dark grey as standard. Matt coffee, matt black, dark bronze, matt grey any other RAL color is available upon request.

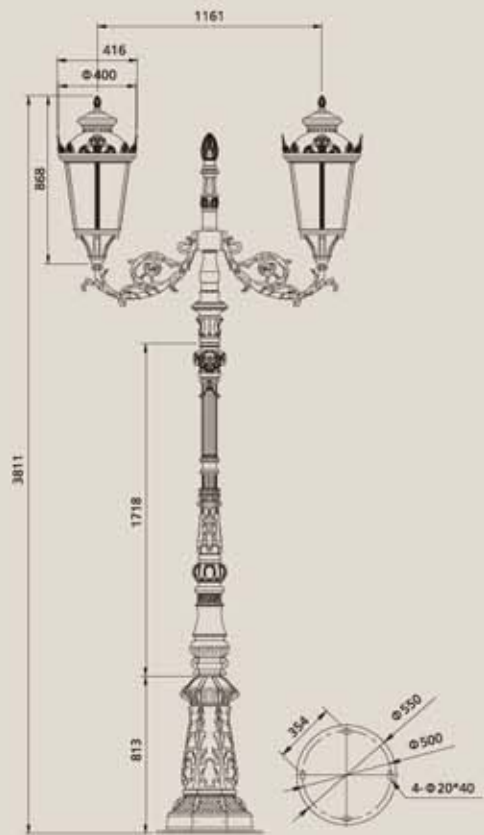

RHS-15684

產品特點:

- 燈體材質: 優質鋁合金鑄造型, 經防腐處理后, 采用防UV靜電粉末噴塗;
- 透光罩: PC奶白燈罩/磨砂玻璃燈罩;
- 緊固件: 不鏽鋼材質, 强度高, 防腐蝕能力強;
- 適用光源: LED 15-24W
- 顏色: 深灰色/沙黑色

PRODUCTS CHARACTERS:

- Body: Made of high quality cast aluminum alloy with treatment of corrosion protection and UV-proof powder coating
- Diffuser: Opal polycarbonate/Frosted glass
- Fastener: Made of stainless steel with high intensity and corrosion protection
- Lamp: LED 15-24W
- Finish: Matt coffee as standard. Dark grey, Matt black, Matt grey, Dark bronze any other RAL color is available upon request.

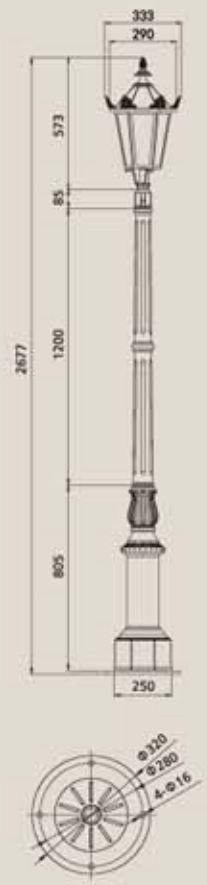

RHS-16481

RHS-17364

產品特點:

- 燈體材質: 優質鋁合金鑄造成型, 經防腐處理后, 采用防UV靜電粉末噴塗;
- 透光罩: 磨砂玻璃燈罩/PC奶白燈罩;
- 緊固件: 不鏽鋼材質, 强度高, 防腐蝕能力強;
- 適用光源: LED 36-45W
- 顏色: 咖啡色/沙黑色

PRODUCTS CHARACTERS:

- Body: Made of high quality cast aluminum alloy with treatment of corrosion protection and UV-proof powder coating
- Diffuser: Frosted glass/Opal polycarbonate
- Fastener: Made of stainless steel with high intensity and corrosion protection
- Lamp: LED 36-45W
- Finish: Matt coffee as standard. Dark grey, Matt grey, Dark bronze, Matt black any other RAL color is available upon request.

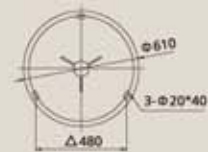

RHS-16302



RHS-16306

產品特點:

- 燈體材質: 優質鋁合金鑄造成型, 經防腐處理后, 采用防UV靜電粉末噴塗;
- 透光罩: PC磨砂燈罩;
- 反光器: 高純鋁反光器, 經陽極氧化處理;
- 緊固件: 不鏽鋼材質, 强度高, 防腐蝕能力強;
- 適用光源: LED 24-36W
- 顏色: 沙黑色

PRODUCTS CHARACTERS:

- Body: Made of high quality cast aluminum alloy with treatment of corrosion protection and UV-proof powder coating
- Diffuser: Frosted polycarbonate
- Reflector: Made of anodized high pure aluminum
- Fastener: Made of stainless steel with high intensity and corrosion protection
- Lamp: LED 24-36W
- Finish: Matt black as standard. Dark grey, Dark bronze, Matt coffee, Matt grey any other RAL color is available upon request.

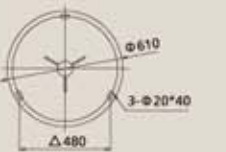

RHS-16300

產品特點:

- 燈體材質: 優質鋁製品, 經防腐處理后, 采用防UV靜電粉末噴塗;
- 透光罩: PC奶白燈罩;
- 反光器: 高純鋁反光器, 經陽極氧化處理;
- 緊固件: 不鏽鋼材質, 强度高, 防腐蝕能力強;
- 適用光源: LED 36-45W
- 顏色: 深灰色

PRODUCTS CHARACTERS:

- Body: Made of high quality cast aluminum and iron alloy with treatment of corrosion protection and UV-proof powder coating
- Diffuser: Opal polycarbonate
- Reflector: Made of anodized high pure aluminum
- Fastener: Made of stainless steel with high intensity and corrosion protection
- Lamp: LED 36-45W
- Finish: Dark grey as standard. Matt coffee, Matt grey, Dark bronze, Matt black any other RAL color is available upon request.

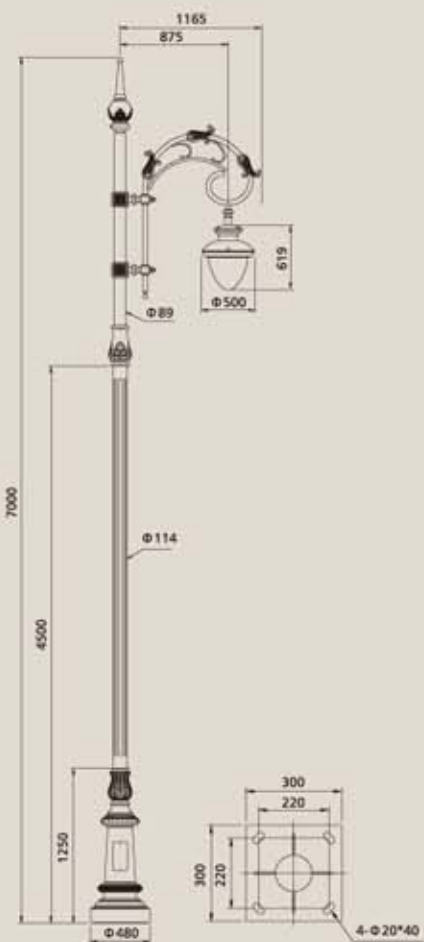

RHS-17365

產品特點:

- 燈體材質: 優質鋁製品, 經防腐處理后, 采用防UV靜電粉末噴塗;
- 透光罩: PC奶白燈罩;
- 反光器: 高純鋁反光器, 經陽極氧化處理;
- 緊固件: 不鏽鋼材質, 强度高, 防腐蝕能力強;
- 適用光源: LED 36-45W
- 顏色: 沙銀色

PRODUCTS CHARACTERS:

- Body: Made of high quality cast aluminum and iron alloy with treatment of corrosion protection and UV-proof powder coating
- Diffuser: Opal polycarbonate
- Reflector: Made of anodized high pure aluminum
- Fastener: Made of stainless steel with high intensity and corrosion protection
- Lamp: LED 36-45W
- Finish: Matt grey as standard. Dark grey, Matt coffee, Dark bronze, Matt black any other RAL color is available upon request.

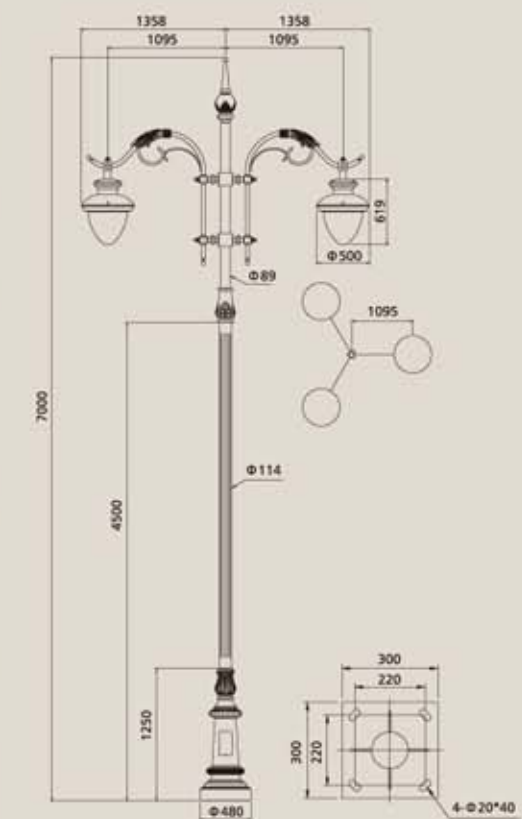

RHS-17366

產品特點:

- 燈體材質: 優質鋁製品, 經防腐處理后, 采用防UV靜電粉末噴塗;
- 透光罩: PC磨砂燈罩;
- 反光器: 高純鋁反光器, 經陽極氧化處理;
- 緊固件: 不鏽鋼材質, 强度高, 防腐蝕能力強;
- 適用光源: LED 36-45W
- 顏色: 深灰色

PRODUCTS CHARACTERS:

- Body: Made of high quality cast aluminum and iron alloy with treatment of corrosion protection and UV-proof powder coating
- Diffuser: Frosted polycarbonate
- Reflector: Made of anodized high pure aluminum
- Fastener: Made of stainless steel with high intensity and corrosion protection
- Lamp: LED 36-45W
- Finish: Dark grey as standard. Matt coffee, Matt grey, Dark bronze, Matt black any other RAL color is available upon request.

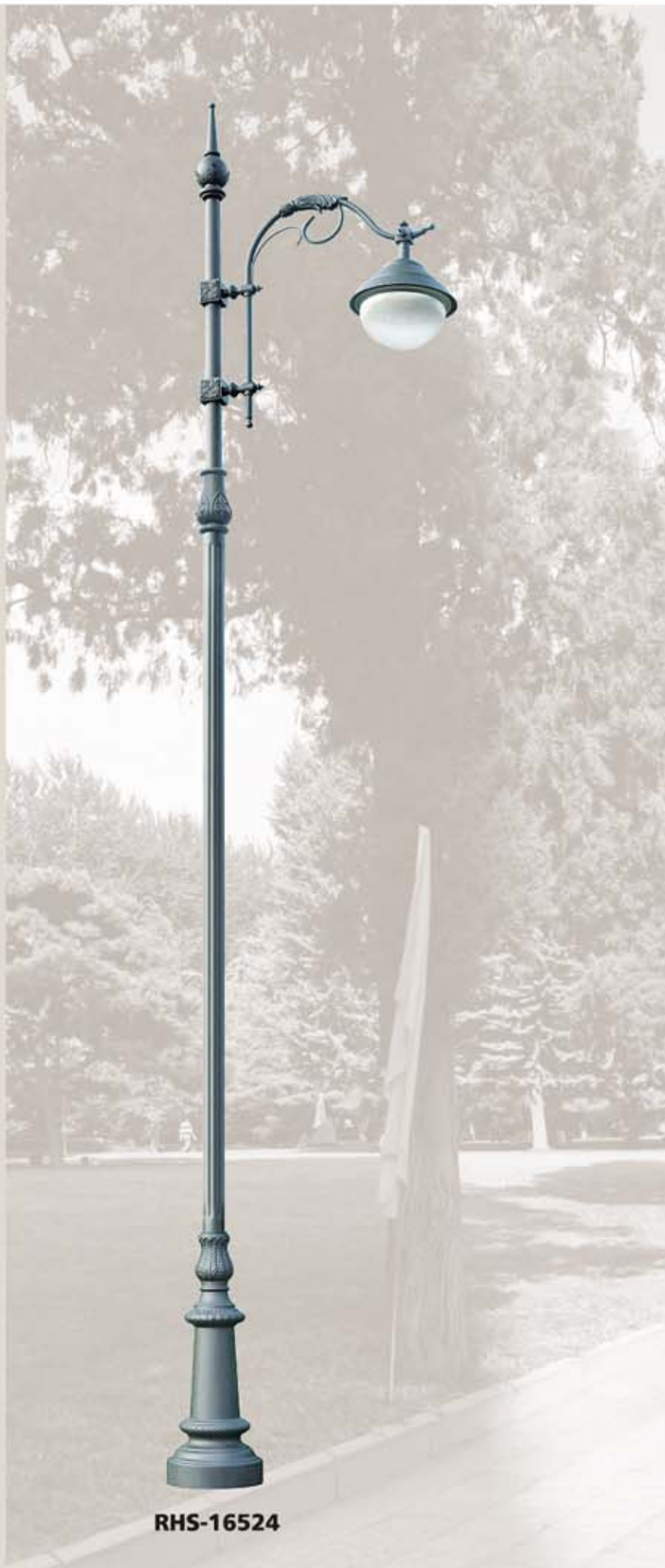
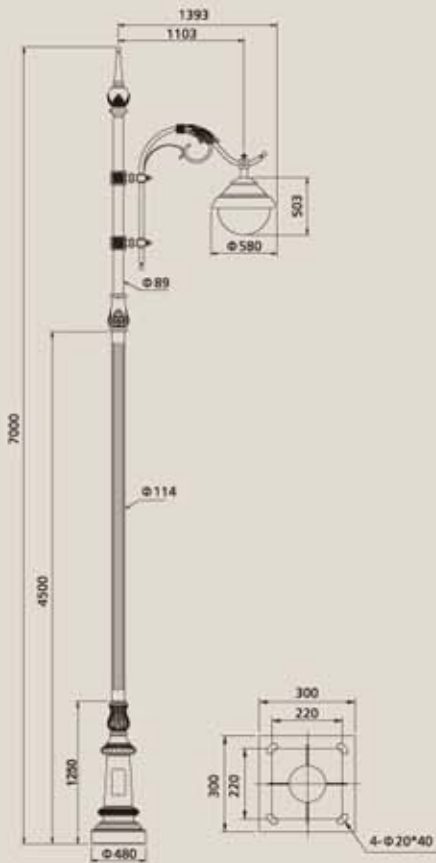

RHS-16524

產品特點:

- 燈體材質: 優質鋁製品, 經防腐處理后, 采用防UV靜電粉末噴塗;
- 透光罩: PC磨砂燈罩;
- 反光器: 高純鋁反光器, 經陽極氧化處理;
- 緊固件: 不鏽鋼材質, 强度高, 防腐蝕能力強;
- 適用光源: LED 36-45W
- 顏色: 深灰色

PRODUCTS CHARACTERS:

- Body: Made of high quality cast aluminum and iron alloy with treatment of corrosion protection and UV-proof powder coating
- Diffuser: Frosted polycarbonate
- Reflector: Made of anodized high pure aluminum
- Fastener: Made of stainless steel with high intensity and corrosion protection
- Lamp: LED 36-45W
- Finish: Dark grey as standard. Matt coffee, Matt grey, Dark bronze, Matt black any other RAL color is available upon request.

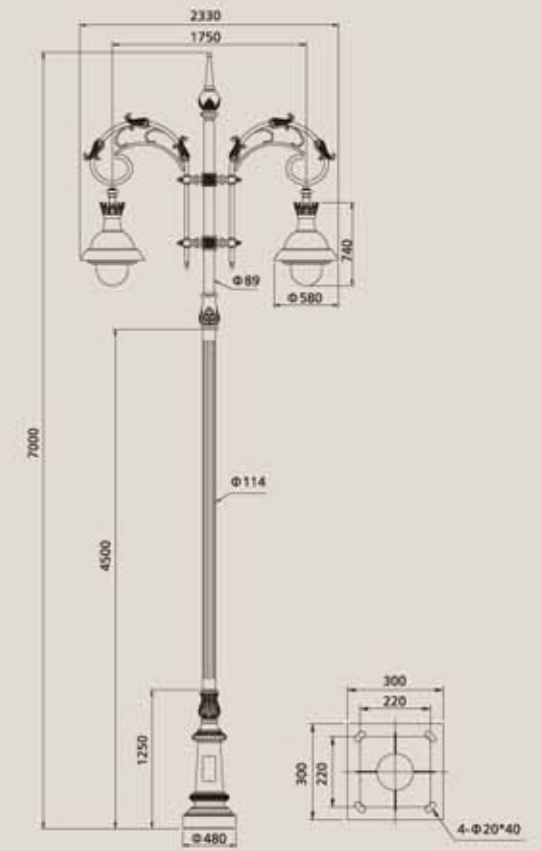

RHS-16527

產品特點:

- 燈體材質: 優質鋁合金鑄造成型, 經防腐處理后, 采用防UV靜電粉末噴塗;
- 透光罩: PC奶白燈罩;
- 緊固件: 不鏽鋼材質, 强度高, 防腐蝕能力強;
- 適用光源: LED 24-36W
- 顏色: 深灰色

PRODUCTS CHARACTERS:

- Body: Made of high quality cast aluminum alloy with treatment of corrosion protection and UV-proof powder coating
- Diffuser: Opal polycarbonate
- Fastener: Made of stainless steel with high intensity and corrosion protection
- Lamp: LED 24-36W
- Finish: Dark grey as standard. Matt black, Matt grey, Dark bronze, Matt coffee any other RAL color is available upon request.

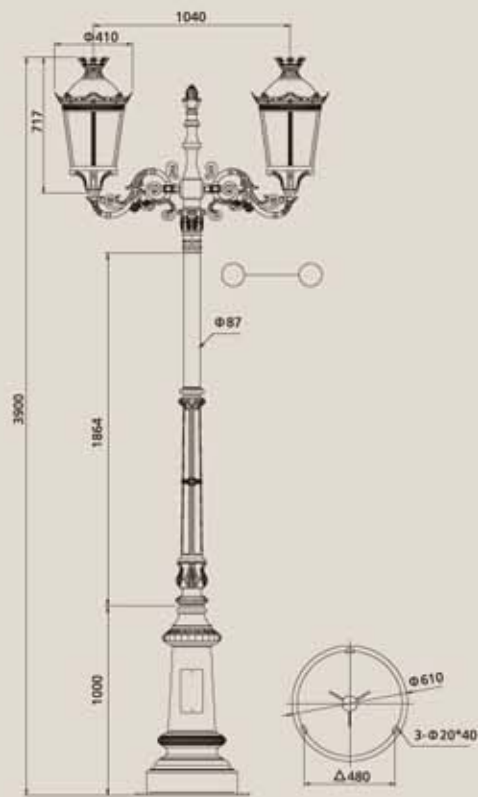

RHS-16296

產品特點:

- 燈體材質: 優質鋁合金鑄造成型, 經防腐處理后, 采用防UV靜電粉末噴塗;
- 透光罩: 磨砂玻璃燈罩/PC奶白燈罩;
- 緊固件: 不鏽鋼材質, 强度高, 防腐蝕能力強;
- 適用光源: LED 15-24W
- 顏色: 深灰色/咖啡色

PRODUCTS CHARACTERS:

- Body: Made of high quality cast aluminum alloy with treatment of corrosion protection and UV-proof powder coating
- Diffuser: Frosted glass/Opal polycarbonate
- Fastener: Made of stainless steel with high intensity and corrosion protection
- Lamp: LED 15-24W
- Finish: Matt coffee as standard. Dark grey, Matt black, Dark bronze any other RAL color is available upon request.



RHS-17367



RHS-17368



RHS-17369



產品特點:

- 燈體材質: 優質鋁合金鑄造成型, 經防腐處理后, 采用防UV靜電粉末噴塗;
- 透光罩: PC透明燈罩/磨砂玻璃燈罩;
- 反光器: 高純鋁反光器, 經陽極氧化處理;
- 緊固件: 不鏽鋼材質, 强度高, 防腐蝕能力強;
- 適用光源: LED 24-36W
- 顏色: 咖啡色

PRODUCTS CHARACTERS:

- Body: Made of high quality cast aluminum alloy with treatment of corrosion protection and UV-proof powder coating
- Diffuser: Clear polycarbonate/Frosted glass
- Reflector: Made of anodized high pure aluminum
- Fastener: Made of stainless steel with high intensity and corrosion protection
- Lamp: LED 24-36W
- Finish: Matt coffee as standard. Dark grey, Matt grey, Dark bronze, Matt black any other RAL color is available upon request.

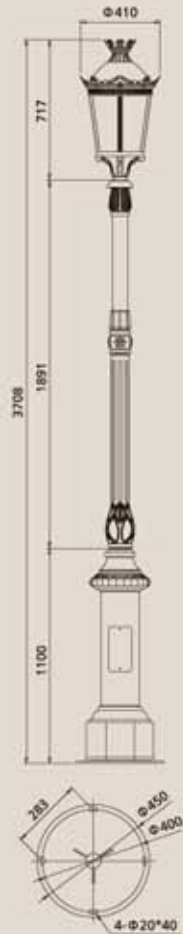

RHS-16327



RHS-16323



RHS-16321

產品特點:

- 燈體材質: 優質鋁合金鑄造成型, 經防腐處理后, 采用防UV靜電粉末噴塗;
- 透光罩: PC透明燈罩/磨砂玻璃燈罩;
- 緊固件: 不鏽鋼材質, 强度高, 防腐蝕能力強;
- 適用光源: LED 15-24W
- 顏色: 沙黑色

PRODUCTS CHARACTERS:

- Body: Made of high quality cast aluminum alloy with treatment of corrosion protection and UV-proof powder coating
- Diffuser: Frosted polycarbonate
- Fastener: Made of stainless steel with high intensity and corrosion protection
- Lamp: LED 15-24W
- Finish: Matt black as standard. Dark grey, Matt grey, Dark bronze, Matt coffee any other RAL color is available upon request.

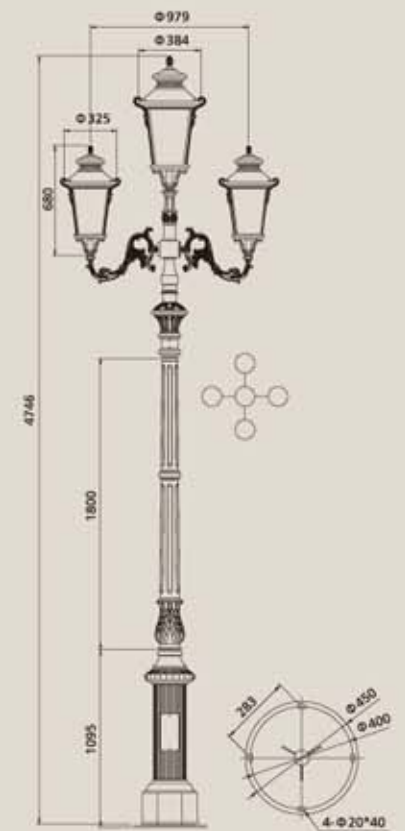

產品特點:

- 燈體材質: 優質鋁合金鑄造成型, 經防腐處理后, 采用防UV靜電粉末噴塗;
- 透光罩: 磨砂玻璃燈罩;
- 反光器: 高純鋁反光器, 經陽極氧化處理;
- 緊固件: 不鏽鋼材質, 强度高, 防腐蝕能力強;
- 適用光源: LED 24-36W
- 顏色: 咖啡色

PRODUCTS CHARACTERS:

- Body: Made of high quality cast aluminum alloy with treatment of corrosion protection and UV-proof powder coating
- Diffuser: Frosted glass
- Reflector: Made of anodized high pure aluminum
- Fastener: Made of stainless steel with high intensity and corrosion protection
- Lamp: LED 24-36W
- Finish: Matt black as standard. Dark grey, Matt grey, Dark bronze, Matt coffee any other RAL color is available upon request.

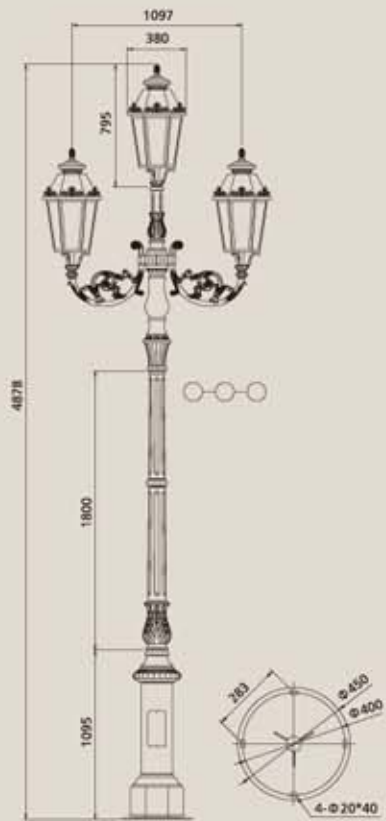

RHS-16320

產品特點:

- 燈體材質: 優質鋁合金鑄造成型, 經防腐處理后, 采用防UV靜電粉末噴塗;
- 透光罩: 透明玻璃燈罩;
- 反光器: 高純鋁反光器, 經陽極氧化處理;
- 緊固件: 不鏽鋼材質, 强度高, 防腐蝕能力強;
- 適用光源: LED 24-36W
- 顏色: 沙黑色

PRODUCTS CHARACTERS:

- Body: Made of high quality cast aluminum alloy with treatment of corrosion protection and UV-proof powder coating
- Diffuser: Clear glass
- Reflector: Made of anodized high pure aluminum
- Fastener: Made of stainless steel with high intensity and corrosion protection
- Lamp: LED 24-36W
- Finish: Matt black as standard. Dark grey, Matt grey, Dark bronze, Matt coffee any other RAL color is available upon request.

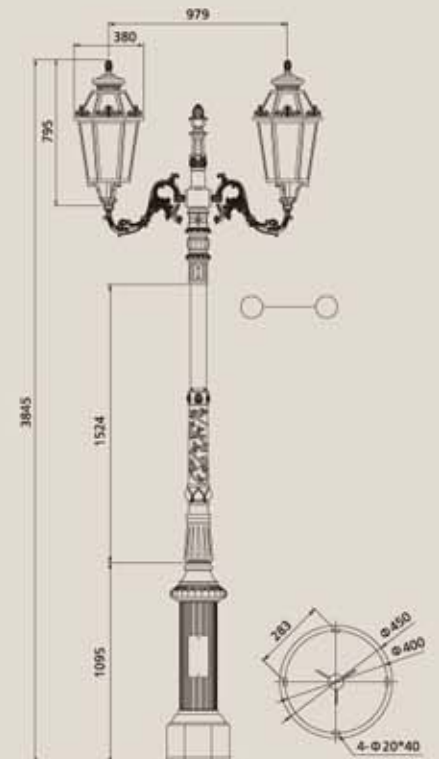

RHS-16339

產品特點:

- 燈體材質: 優質鋁合金鑄造成型, 經防腐處理后, 采用防UV靜電粉末噴塗;
- 透光罩: PC透明燈罩;
- 緊固件: 不鏽鋼材質, 强度高, 防腐蝕能力強;
- 適用光源: LED 15-24W
- 顏色: 沙銀色

PRODUCTS CHARACTERS:

- Body: Made of high quality cast aluminum alloy with treatment of corrosion protection and UV-proof powder coating
- Diffuser: Clear polycarbonate
- Fastener: Made of stainless steel with high intensity and corrosion protection
- Lamp: LED 15-24W
- Finish: Matt grey as standard. Matt coffee, Dark grey, Dark bronze, Matt black any other RAL color is available upon request.



RHS-16331

產品特點:

- 燈體材質: 優質鋁合金鑄造成型, 經防腐處理后, 采用防UV靜電粉末噴塗;
- 透光罩: PC奶白燈罩;
- 緊固件: 不鏽鋼材質, 强度高, 防腐蝕能力強;
- 適用光源: LED 15-24W
- 顏色: 深灰色

PRODUCTS CHARACTERS:

- Body: Made of high quality cast aluminum alloy with treatment of corrosion protection and UV-proof powder coating
- Diffuser: Opal polycarbonate
- Fastener: Made of stainless steel with high intensity and corrosion protection
- Lamp: LED 15-24W
- Finish: Dark grey as standard. Matt coffee, Matt grey, Dark bronze, Matt black any other RAL color is available upon request.

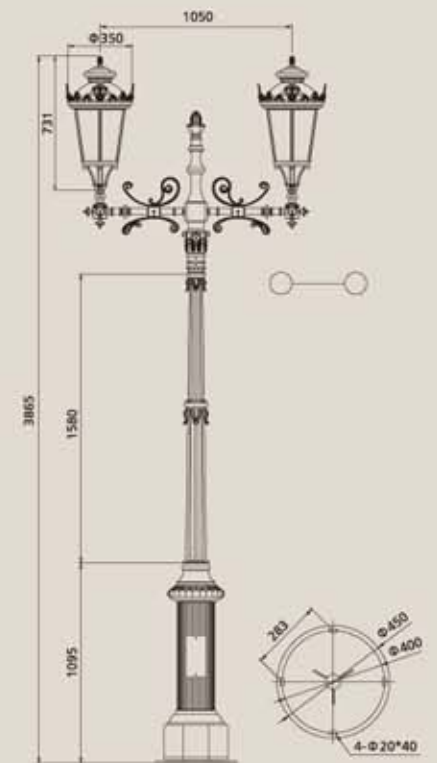

RHS-16329

產品特點:

- 燈體材質: 優質鋁合金鑄造成型, 經防腐處理后, 采用防UV靜電粉末噴塗;
- 透光罩: PC奶白燈罩/磨砂玻璃燈罩;
- 緊固件: 不鏽鋼材質, 强度高, 防腐蝕能力強;
- 適用光源: LED 15-24W
- 顏色: 深灰色/沙銀色

PRODUCTS CHARACTERS:

- Body: Made of high quality cast aluminum alloy with treatment of corrosion protection and UV-proof powder coating
- Diffuser: Opal polycarbonate/Frosted glass
- Fastener: Made of stainless steel with high intensity and corrosion protection
- Lamp: LED 15-24W
- Finish: Matt black as standard. Dark grey, Matt coffee, Dark bronze any other RAL color is available upon request.



RHS-17370



RHS-17371



產品特點:

- 燈體材質: 優質鋁合金鑄造成型, 經防腐處理后, 采用防UV靜電粉末噴塗;
- 透光罩: 磨砂玻璃燈罩;
- 緊固件: 不鏽鋼材質, 强度高, 防腐蝕能力強;
- 適用光源: LED 15-24W
- 顏色: 深灰色/沙銀色

PRODUCTS CHARACTERS:

- Body: Made of high quality cast aluminum alloy with treatment of corrosion protection and UV-proof powder coating
- Diffuser: Frosted glass
- Fastener: Made of stainless steel with high intensity and corrosion protection
- Lamp: LED 15-24W
- Finish: Dark grey as standard. Matt coffee, Matt grey, Dark bronze, Matt black any other RAL color is available upon request.



RHS-17372



RHS-17373

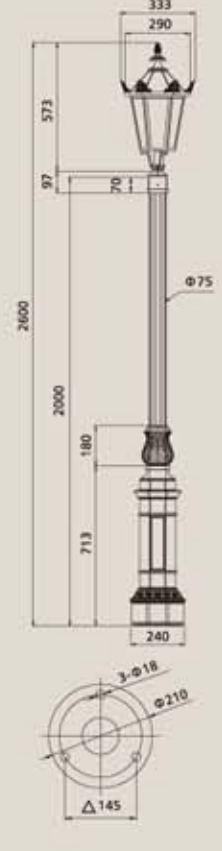

產品特點:

- 燈體材質: 優質鋁合金鑄造成型, 經防腐處理后, 采用防UV靜電粉末噴塗;
- 透光罩: 磨砂玻璃燈罩;
- 緊固件: 不鏽鋼材質, 强度高, 防腐蝕能力強;
- 適用光源: LED 15-24W
- 顏色: 沙銀色

PRODUCTS CHARACTERS:

- Body: Made of high quality cast aluminum alloy with treatment of corrosion protection and UV-proof powder coating
- Diffuser: Frosted glass
- Fastener: Made of stainless steel with high intensity and corrosion protection
- Lamp: LED 15-24W
- Finish: Matt black as standard. Dark grey, Matt grey, Dark bronze, Matt coffee any other RAL color is available upon request.

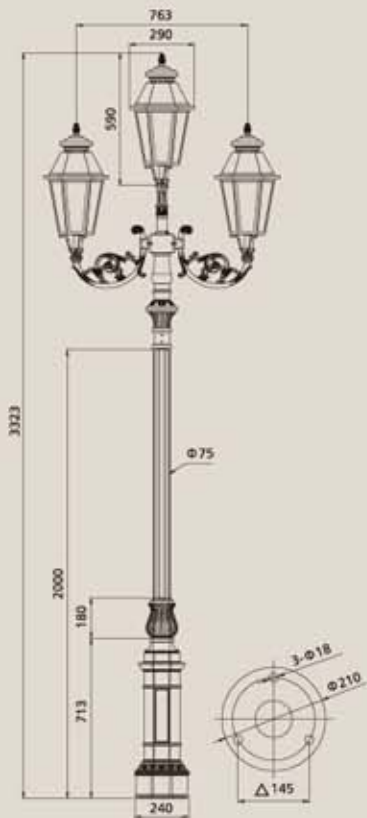

RHS-17374

產品特點:

- 燈體材質: 優質鋁合金鑄造成型, 經防腐處理后, 采用防UV靜電粉末噴塗;
- 透光罩: 磨砂玻璃燈罩/PC奶白燈罩;
- 緊固件: 不鏽鋼材質, 强度高, 防腐蝕能力強;
- 適用光源: LED 36-45W
- 顏色: 深灰色/沙黑色

PRODUCTS CHARACTERS:

- Body: Made of high quality cast aluminum alloy with treatment of corrosion protection and UV-proof powder coating
- Diffuser: Frosted glass/Opal polycarbonate
- Fastener: Made of stainless steel with high intensity and corrosion protection
- Lamp: LED 36-45W
- Finish: Matt black as standard. Dark grey, Matt grey, Dark bronze, Matt coffee any other RAL color is available upon request.



RHS-16350



RHS-16346

產品特點:

- 燈體材質: 優質鋁合金鑄造型, 經防腐處理后, 采用防UV靜電粉末噴塗;
- 透光罩: PC奶白燈罩;
- 緊固件: 不鏽鋼材質, 强度高, 防腐蝕能力強;
- 適用光源: LED 24-36W
- 顏色: 沙黑色

PRODUCTS CHARACTERS:

- Body: Made of high quality cast aluminum alloy with treatment of corrosion protection and UV-proof powder coating
- Diffuser: Opal polycarbonate
- Fastener: Made of stainless steel with high intensity and corrosion protection
- Lamp: LED 24-36W
- Finish: Matt black as standard. Dark grey, Matt grey, Dark bronze, Matt coffee any other RAL color is available upon request.

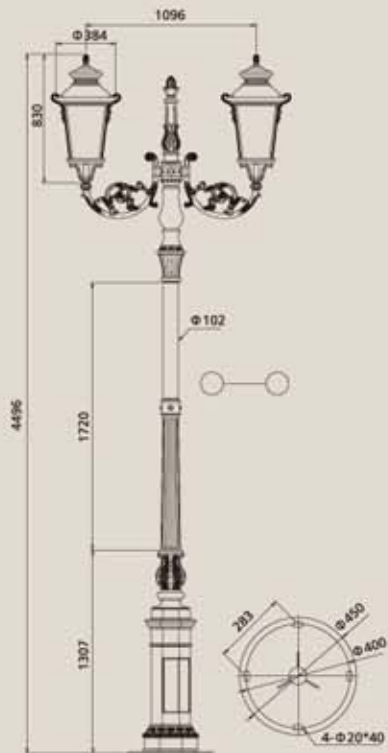

RHS-16341

產品特點:

- 燈體材質: 優質鋁合金鑄造型, 經防腐處理后, 采用防UV靜電粉末噴塗;
- 透光罩: PC奶白燈罩;
- 緊固件: 不鏽鋼材質, 强度高, 防腐蝕能力強;
- 適用光源: LED 24-36W
- 顏色: 深灰色

PRODUCTS CHARACTERS:

- Body: Made of high quality cast aluminum alloy with treatment of corrosion protection and UV-proof powder coating
- Diffuser: Opal polycarbonate
- Fastener: Made of stainless steel with high intensity and corrosion protection
- Lamp: LED 24-36W
- Finish: Dark grey as standard. Matt grey, Dark bronze, Matt coffee, Matt black any other RAL color is available upon request.

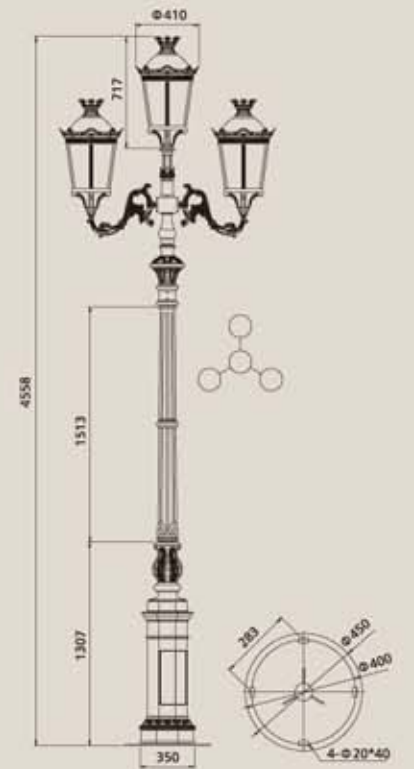

RHS-16352

產品特點:

- 燈體材質: 優質鋁合金鑄造成型, 經防腐處理后, 采用防UV靜電粉末噴塗;
- 透光罩: PC奶白燈罩;
- 緊固件: 不鏽鋼材質, 强度高, 防腐蝕能力強;
- 適用光源: LED 36-45W
- 顏色: 沙黑色

PRODUCTS CHARACTERS:

- Body: Made of high quality cast aluminum alloy with treatment of corrosion protection and UV-proof powder coating
- Diffuser: Opal polycarbonate
- Fastener: Made of stainless steel with high intensity and corrosion protection
- Lamp: LED 36-45W
- Finish: Matt black as standard. Dark grey, Matt grey, Dark bronze, Matt coffee any other RAL color is available upon request.

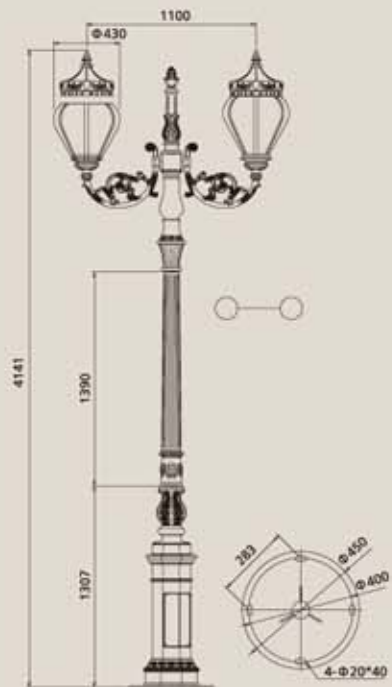

RHS-16356

產品特點:

- 燈體材質: 優質鋁製品, 經防腐處理后, 采用防UV靜電粉末噴塗;
- 透光罩: PC奶白燈罩;
- 反光器: 高純鋁反光器, 經陽極氧化處理;
- 緊固件: 不鏽鋼材質, 强度高, 防腐蝕能力強;
- 適用光源: LED 36-45W
- 顏色: 沙黑色

PRODUCTS CHARACTERS:

- Body: Made of high quality cast aluminum and iron alloy with treatment of corrosion protection and UV-proof powder coating
- Diffuser: Opal polycarbonate
- Reflector: Made of anodized high pure aluminum
- Fastener: Made of stainless steel with high intensity and corrosion protection
- Lamp: LED 36-45W
- Finish: Matt black as standard. Dark grey, Matt grey, Dark bronze, Matt coffee any other RAL color is available upon request.



RHS-16362

產品特點:

- 燈體材質: 優質鋁合金鑄造成型, 經防腐處理后, 采用防UV靜電粉末噴塗;
- 透光罩: PC透明燈罩/PC奶白燈罩;
- 反光器: 高純鋁反光器, 經陽極氧化處理;
- 緊固件: 不鏽鋼材質, 强度高, 防腐蝕能力強;
- 適用光源: LED 24-36W
- 顏色: 沙銀色/深灰色

PRODUCTS CHARACTERS:

- Body: Made of high quality cast aluminum alloy with treatment of corrosion protection and UV-proof powder coating
- Diffuser: Clear polycarbonate/Opal polycarbonate
- Reflector: Made of anodized high pure aluminum
- Fastener: Made of stainless steel with high intensity and corrosion protection
- Lamp: LED 24-36W
- Finish: Matt grey as standard. Dark grey, Dark bronze, Matt coffee, Matt black any other RAL color is available upon request.

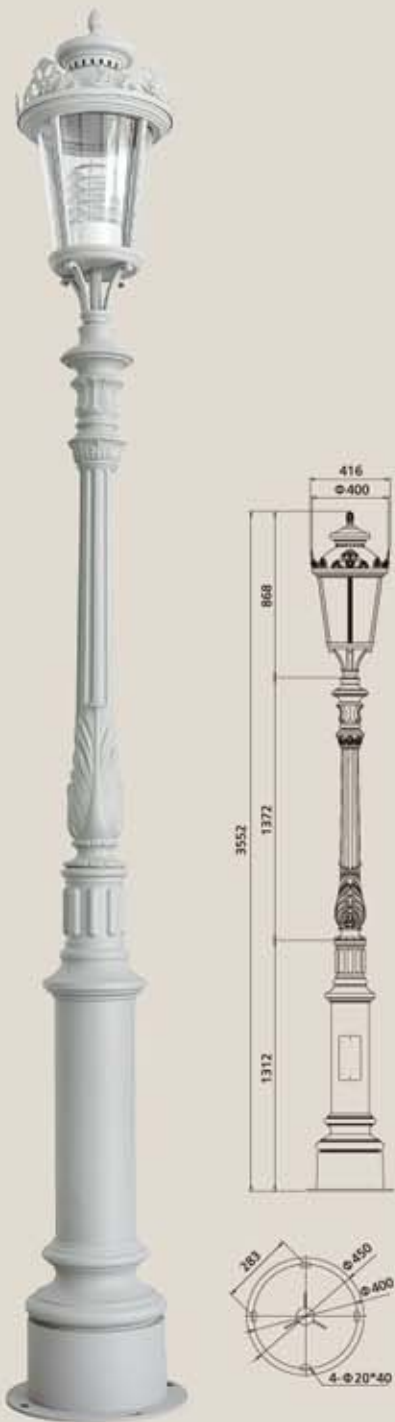

RHS-16274



RHS-16276



RHS-16278

產品特點:

- 燈體材質: 優質鋁合金鑄造成型, 經防腐處理后, 采用防UV靜電粉末噴塗;
- 透光罩: PC透明燈罩;
- 緊固件: 不鏽鋼材質, 强度高, 防腐蝕能力強;
- 適用光源: LED 24-36W
- 顏色: 咖啡色

PRODUCTS CHARACTERS:

- Body: Made of high quality cast aluminum alloy with treatment of corrosion protection and UV-proof powder coating
- Diffuser: Clear polycarbonate
- Fastener: Made of stainless steel with high intensity and corrosion protection
- Lamp: LED 24-36W
- Finish: Matt coffee as standard. Dark grey, Matt grey, Dark bronze, Matt black any other RAL color is available upon request.

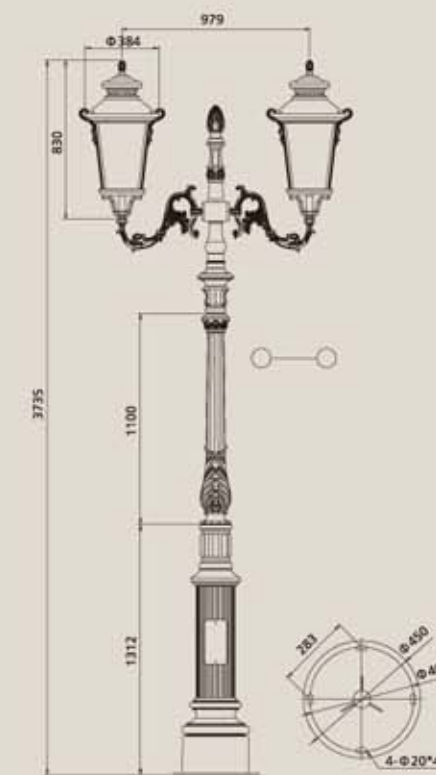

產品特點:

- 燈體材質: 優質鋁合金鑄造成型, 經防腐處理后, 采用防UV靜電粉未噴塗;
- 透光罩: PC磨砂燈罩;
- 緊固件: 不鏽鋼材質, 强度高, 防腐蝕能力強;
- 適用光源: LED 24-36W
- 顏色: 深灰色

PRODUCTS CHARACTERS:

- Body: Made of high quality cast aluminum alloy with treatment of corrosion protection and UV-proof powder coating
- Diffuser: Frosted polycarbonate
- Fastener: Made of stainless steel with high intensity and corrosion protection
- Lamp: LED 24-36W
- Finish: Dark grey as standard. Matt coffee, Matt grey, Dark bronze, Matt black any other RAL color is available upon request.

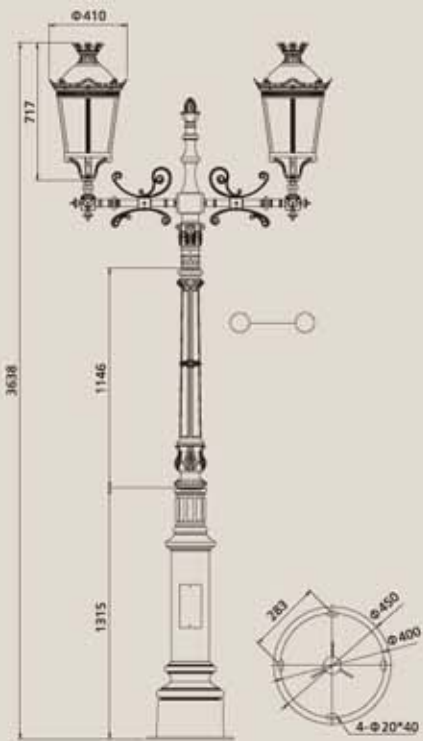

RHS-16288

產品特點:

- 燈體材質: 優質鋁合金鑄造成型, 經防腐處理后, 采用防UV靜電粉未噴塗;
- 透光罩: PC磨砂燈罩/PC奶白燈罩;
- 緊固件: 不鏽鋼材質, 强度高, 防腐蝕能力強;
- 適用光源: LED 15-24W
- 顏色: 沙黑色/沙銀色

PRODUCTS CHARACTERS:

- Body: Made of high quality cast aluminum alloy with treatment of corrosion protection and UV-proof powder coating
- Diffuser: Frosted polycarbonate/Opal polycarbonate
- Fastener: Made of stainless steel with high intensity and corrosion protection
- Lamp: LED 15-24W
- Finish: Matt black as standard. Dark grey, Matt grey, Dark bronze, Matt coffee any other RAL color is available upon request.



RHS-16408

RHS-16410

RHS-16412

產品特點:

- 燈體材質: 優質鋁合金鑄造型, 經防腐處理后, 采用防UV靜電粉末噴塗;
- 透光罩: 磨砂玻璃燈罩;
- 緊固件: 不鏽鋼材質, 强度高, 防腐蝕能力強;
- 適用光源: LED 24-36W
- 顏色: 咖啡色

PRODUCTS CHARACTERS:

- Body: Made of high quality cast aluminum alloy with treatment of corrosion protection and UV-proof powder coating
- Diffuser: Frosted glass
- Fastener: Made of stainless steel with high intensity and corrosion protection
- Lamp: LED 24-36W
- Finish: Matt coffee as standard. Dark grey, Matt grey, Dark bronze, Matt black any other RAL color is available upon request.

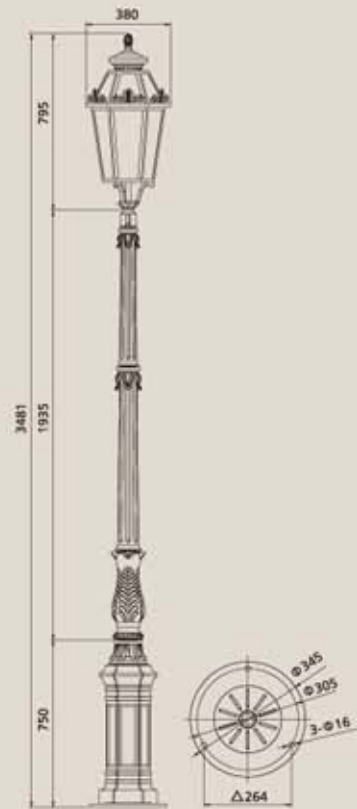

RHS-16405

產品特點:

- 燈體材質: 優質鋁合金鑄造型, 經防腐處理后, 采用防UV靜電粉末噴塗;
- 透光罩: 磨砂玻璃燈罩;
- 緊固件: 不鏽鋼材質, 强度高, 防腐蝕能力強;
- 適用光源: LED 15-24W
- 顏色: 咖啡色

PRODUCTS CHARACTERS:

- Body: Made of high quality cast aluminum alloy with treatment of corrosion protection and UV-proof powder coating
- Diffuser: Frosted glass
- Fastener: Made of stainless steel with high intensity and corrosion protection
- Lamp: LED 15-24W
- Finish: Matt coffee as standard. Dark grey, Matt grey, Dark bronze, Matt black any other RAL color is available upon request.

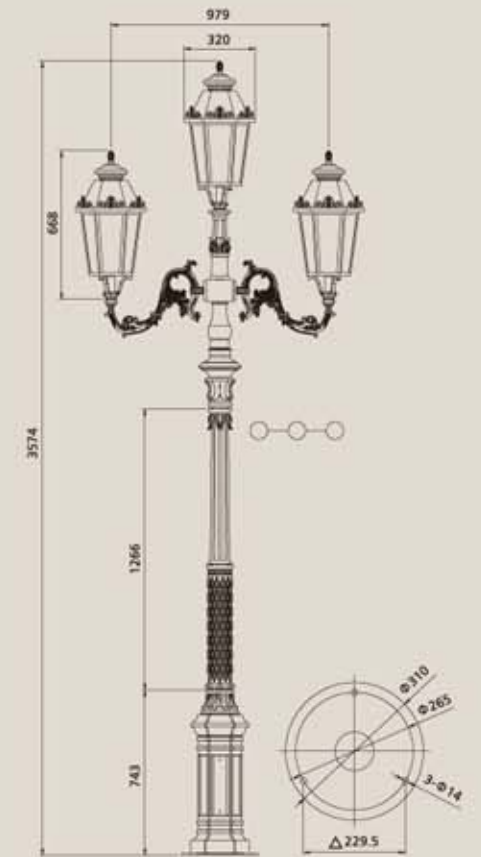

RHS-16416

產品特點:

- 燈體材質: 優質鋁合金鑄造型, 經防腐處理后, 采用防UV靜電粉末噴塗;
- 透光罩: 磨砂玻璃燈罩;
- 緊固件: 不鏽鋼材質, 强度高, 防腐蝕能力強;
- 適用光源: LED 15-24W
- 顏色: 深灰色/沙黑色

PRODUCTS CHARACTERS:

- Body: Made of high quality cast aluminum alloy with treatment of corrosion protection and UV-proof powder coating
- Diffuser: Frosted glass
- Fastener: Made of stainless steel with high intensity and corrosion protection
- Lamp: LED 15-24W
- Finish: Matt black as standard. Dark grey, Matt grey, Dark bronze, Matt coffee any other RAL color is available upon request.



RHS-17375

RHS-17376

產品特點:

- 燈體材質: 優質鋁合金鑄造型, 經防腐處理后, 采用防UV靜電粉末噴塗;
- 透光罩: 磨砂玻璃燈罩;
- 緊固件: 不鏽鋼材質, 强度高, 防腐蝕能力強;
- 適用光源: LED 15-24W
- 顏色: 沙銀色

PRODUCTS CHARACTERS:

- Body: Made of high quality cast aluminum alloy with treatment of corrosion protection and UV-proof powder coating
- Diffuser: Frosted glass
- Fastener: Made of stainless steel with high intensity and corrosion protection
- Lamp: LED 15-24W
- Finish: Matt coffee as standard. Dark grey, Matt grey, Dark bronze, Matt black any other RAL color is available upon request.



RHS-17377

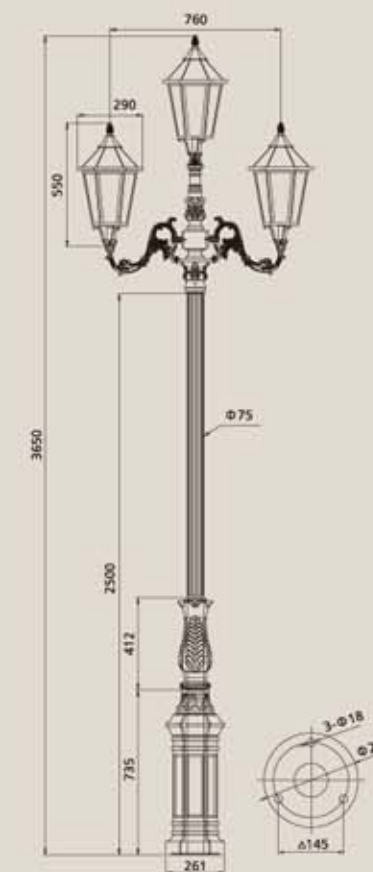

產品特點:

- 燈體材質: 優質鋁合金鑄造成型, 經防腐處理后, 采用防UV靜電粉末噴塗;
- 透光罩: PC透明燈罩/PC磨砂燈罩;
- 反光器: 高純鋁反光器, 經陽極氧化處理;
- 緊固件: 不鏽鋼材質, 强度高, 防腐蝕能力強;
- 適用光源: LED 24-36W
- 顏色: 沙黑色/深灰色

PRODUCTS CHARACTERS:

- Body: Made of high quality cast aluminum alloy with treatment of corrosion protection and UV-proof powder coating
- Diffuser: Clear polycarbonate/Frosted polycarbonate
- Reflector: Made of anodized high pure aluminum
- Fastener: Made of stainless steel with high intensity and corrosion protection
- Lamp: LED 24-36W
- Finish: Matt black as standard. Dark grey, Dark bronze, Matt coffee, Matt grey any other RAL color is available upon request.



RHS-16424

RHS-16418

產品特點:

- 燈體材質: 優質鋁合金鑄造成型, 經防腐處理后, 采用防UV靜電粉末噴塗;
- 透光罩: PC磨砂燈罩;
- 緊固件: 不鏽鋼材質, 强度高, 防腐蝕能力強;
- 適用光源: LED 24-36W
- 顏色: 深灰色

PRODUCTS CHARACTERS:

- Body: Made of high quality cast aluminum alloy with treatment of corrosion protection and UV-proof powder coating
- Diffuser: Frosted polycarbonate
- Fastener: Made of stainless steel with high intensity and corrosion protection
- Lamp: LED 24-36W
- Finish: Dark grey as standard. Matt coffee, Matt grey, Dark bronze, Matt black any other RAL color is available upon request.



RHS-16430

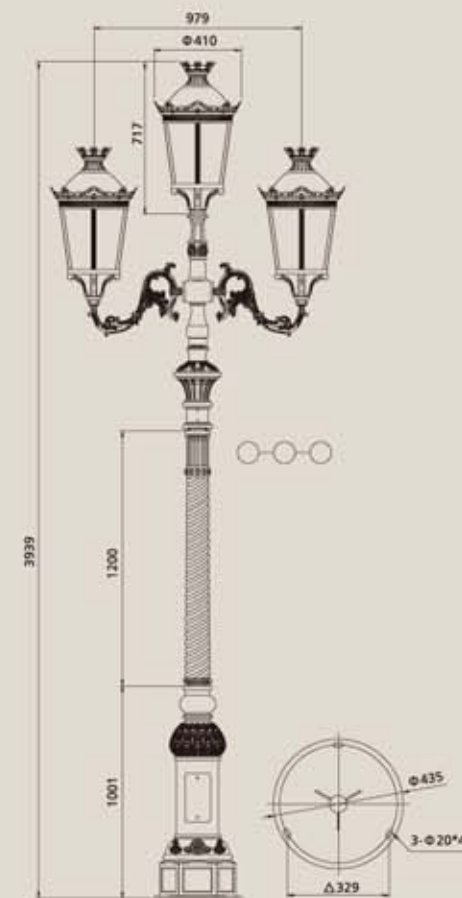

產品特點:

- 燈體材質: 優質鋁合金鑄造型, 經防腐處理后, 采用防UV靜電粉末噴塗;
- 透光罩: 磨砂玻璃燈罩/PC透明燈罩;
- 緊固件: 不鏽鋼材質, 强度高, 防腐蝕能力強;
- 適用光源: LED 24-36W
- 顏色: 深灰色/沙銀色

PRODUCTS CHARACTERS:

- Body: Made of high quality cast aluminum alloy with treatment of corrosion protection and UV-proof powder coating
- Diffuser: Frosted glass/Clear polycarbonate
- Fastener: Made of stainless steel with high intensity and corrosion protection
- Lamp: LED 24-36W
- Finish: Dark grey as standard. Matt coffee, Matt grey, Dark bronze, Matt black any other RAL color is available upon request.

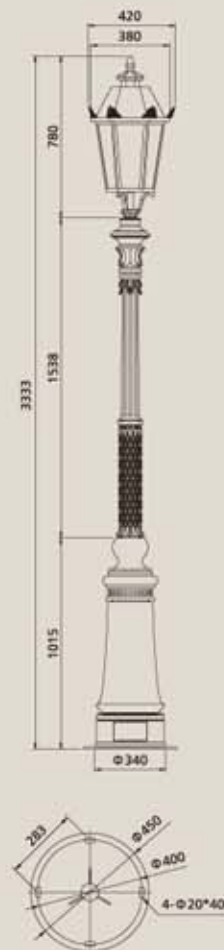

RHS-16511



RHS-16515

產品特點:

- 燈體材質: 優質鋁合金鑄造型, 經防腐處理后, 采用防UV靜電粉末噴塗;
- 透光罩: PC奶白燈罩;
- 緊固件: 不鏽鋼材質, 强度高, 防腐蝕能力強;
- 適用光源: LED 24-36W
- 顏色: 沙銀色/深灰色

PRODUCTS CHARACTERS:

- Body: Made of high quality cast aluminum alloy with treatment of corrosion protection and UV-proof powder coating
- Diffuser: Opal polycarbonate
- Fastener: Made of stainless steel with high intensity and corrosion protection
- Lamp: LED 24-36W
- Finish: Dark grey as standard. Matt black, Matt grey, Dark bronze, Matt coffee any other RAL color is available upon request.



RHS-16519

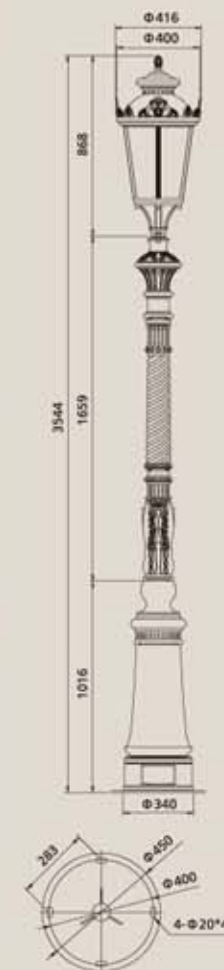

RHS-16517

產品特點:

- 燈體材質: 優質鋁合金鑄造成型, 經防腐處理后, 采用防UV靜電粉未噴塗;
- 透光罩: PC奶白燈罩;
- 緊固件: 不鏽鋼材質, 强度高, 防腐蝕能力強;
- 適用光源: LED 15-24W
- 顏色: 沙黑色

PRODUCTS CHARACTERS:

- Body: Made of high quality cast aluminum alloy with treatment of corrosion protection and UV-proof powder coating
- Diffuser: Opal polycarbonate
- Fastener: Made of stainless steel with high intensity and corrosion protection
- Lamp: LED 15-24W
- Finish: Matt black as standard. Dark grey, Matt grey, Dark bronze, Matt coffee any other RAL color is available upon request.

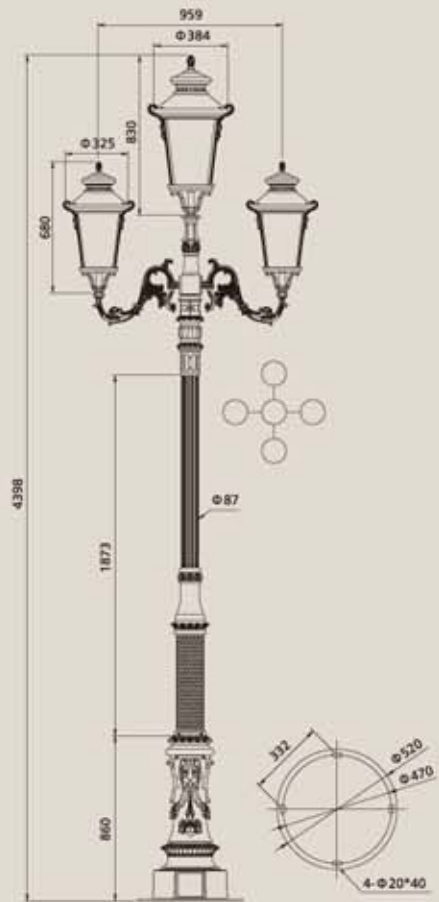

RHS-16364

產品特點:

- 燈體材質: 優質鋁合金鑄造成型, 經防腐處理后, 采用防UV靜電粉未噴塗;
- 透光罩: PC奶白燈罩/奶白塑料燈罩;
- 緊固件: 不鏽鋼材質, 强度高, 防腐蝕能力強;
- 適用光源: LED 24-36W
- 顏色: 沙黑色

PRODUCTS CHARACTERS:

- Body: Made of high quality cast aluminum alloy with treatment of corrosion protection and UV-proof powder coating
- Diffuser: Opal polycarbonate/Opal plastic
- Fastener: Made of stainless steel with high intensity and corrosion protection
- Lamp: LED 24-36W
- Finish: Matt red as standard. Dark grey, Matt grey, Dark bronze, Matt coffee, Matt black any other RAL color is available upon request.

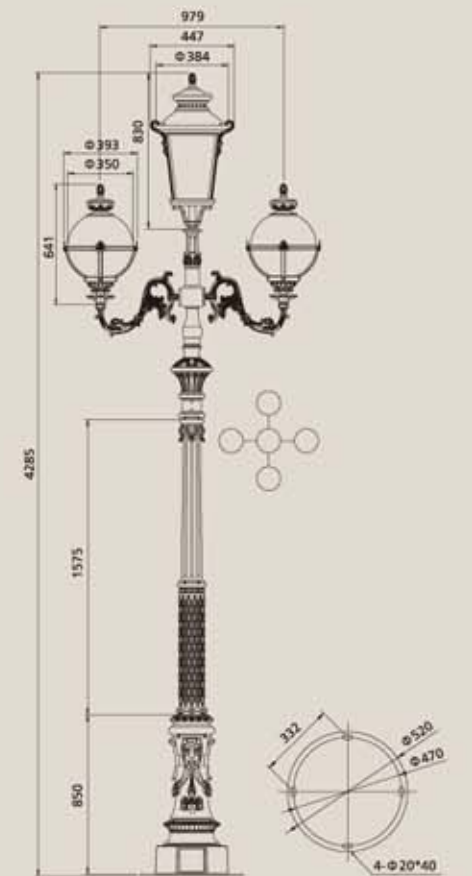

RHS-16373

產品特點:

- 燈體材質: 優質鋁合金鑄造成型, 經防腐處理后, 采用防UV靜電粉末噴塗;
- 透光罩: PC奶白燈罩;
- 緊固件: 不鏽鋼材質, 强度高, 防腐蝕能力強;
- 適用光源: LED 36-45W
- 顏色: 沙紅色/深灰色

PRODUCTS CHARACTERS:

- Body: Made of high quality cast aluminum alloy with treatment of corrosion protection and UV-proof powder coating
- Diffuser: Opal polycarbonate
- Fastener: Made of stainless steel with high intensity and corrosion protection
- Lamp: LED 36-45W
- Finish: Matt red as standard. Dark grey, Matt grey, Dark bronze, Matt coffee, Matt black any other RAL color is available upon request.



RHS-16370



RHS-16371



RHS-16375

產品特點:

- 燈體材質: 優質鋁合金鑄造成型, 經防腐處理后, 采用防UV靜電粉末噴塗;
- 透光罩: PC奶白燈罩;
- 緊固件: 不鏽鋼材質, 强度高, 防腐蝕能力強;
- 適用光源: LED 24-36W
- 顏色: 沙黑色

PRODUCTS CHARACTERS:

- Body: Made of high quality cast aluminum alloy with treatment of corrosion protection and UV-proof powder coating
- Diffuser: Opal polycarbonate
- Fastener: Made of stainless steel with high intensity and corrosion protection
- Lamp: LED 24-36W
- Finish: Matt black as standard. Dark grey, Matt grey, Dark bronze, Matt coffee any other RAL color is available upon request.

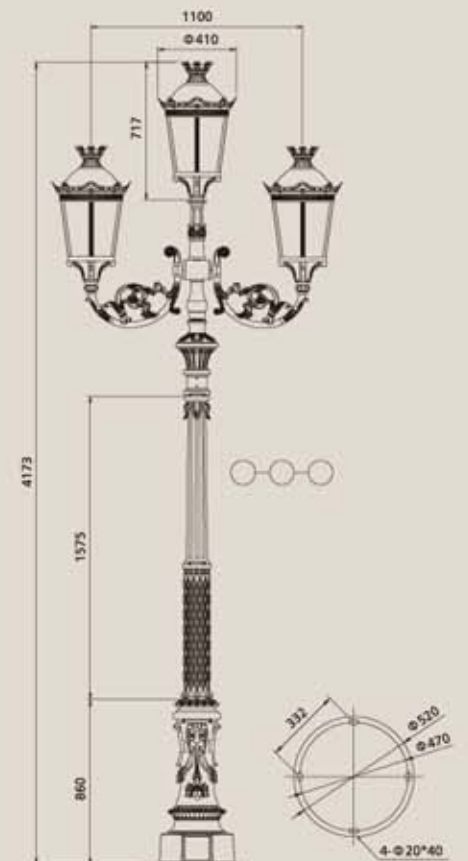

產品特點:

- 燈體材質: 優質鋁合金鑄造成型, 經防腐處理后, 采用防UV靜電粉末噴塗;
- 透光罩: PC透明燈罩;
- 反光器: 高純鋁反光器, 經陽極氧化處理;
- 緊固件: 不鏽鋼材質, 强度高, 防腐蝕能力強;
- 適用光源: LED 24-36W
- 顏色: 沙銀色

PRODUCTS CHARACTERS:

- Body: Made of high quality cast aluminum alloy with treatment of corrosion protection and UV-proof powder coating
- Diffuser: Clear polycarbonate
- Reflector: Made of anodized high pure aluminum
- Fastener: Made of stainless steel with high intensity and corrosion protection
- Lamp: LED 24-36W
- Finish: Matt grey as standard. Dark grey, Dark bronze, Matt coffee, Matt black any other RAL color is available upon request.

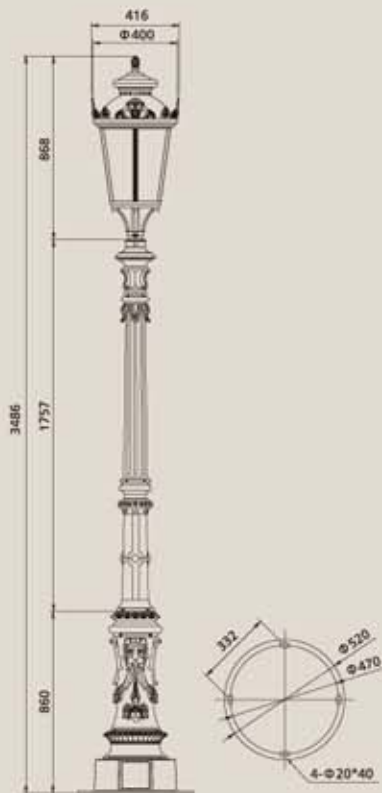

RHS-16377

產品特點:

- 燈體材質: 優質鋁合金鑄造成型, 經防腐處理后, 采用防UV靜電粉末噴塗;
- 透光罩: PC奶白燈罩;
- 緊固件: 不鏽鋼材質, 强度高, 防腐蝕能力強;
- 適用光源: LED 36-45W
- 顏色: 咖啡色

PRODUCTS CHARACTERS:

- Body: Made of high quality cast aluminum alloy with treatment of corrosion protection and UV-proof powder coating
- Diffuser: Opal polycarbonate
- Fastener: Made of stainless steel with high intensity and corrosion protection
- Lamp: LED 36-45W
- Finish: Matt grey as standard. Dark grey, Dark bronze, Matt coffee, Matt black any other RAL color is available upon request.

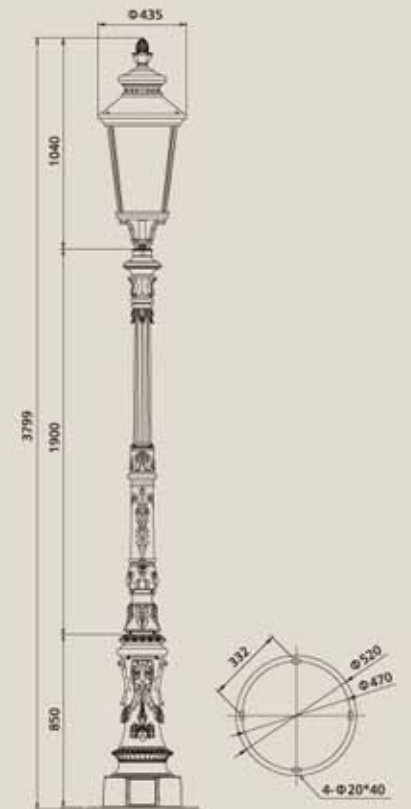

RHS-16381

RHS-17380



RHS-17381



RHS-17384



RHS-17385



RHS-17382



RHS-17383



RHS-17386



RHS-17387



•燈體材質：優質鋁合金鑄造成型；
•透光罩：PC燈罩；

•Body: Made of high quality cast aluminum.
•Diffuser: Polycarbonate.

•燈體材質：優質鋁合金鑄造成型；
•透光罩：玻璃燈罩；

•Body: Made of high quality cast aluminum.
•Diffuser: Glass.

RHS-17388



RHS-17390

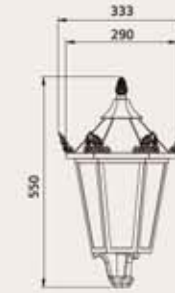

RHS-17391

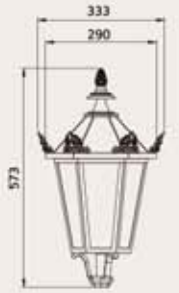

RHS-17389



RHS-17392



RHS-17393



- 燈體材質：優質鋁合金鑄造成型；
- 透光罩：玻璃燈罩；
- Body: Made of high quality cast aluminum.
- Diffuser: Glass.

- 燈體材質：優質鋁合金鑄造成型；
- 透光罩：玻璃燈罩；
- Body: Made of high quality cast aluminum.
- Diffuser: Glass.

RHS-17394

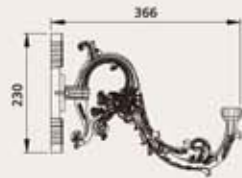

RHS-17397

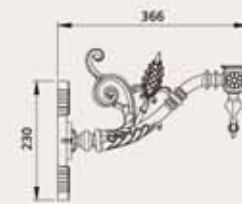

RHS-17398



RHS-17395

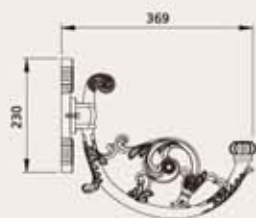

RHS-17396

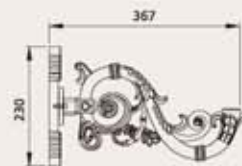

RHS-17399

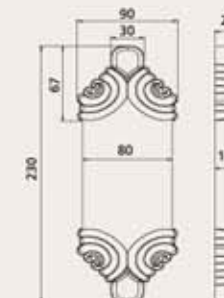

RHS-17400



•燈體材質：優質鋁合金鑄造成型； •Body: Made of high quality cast aluminum.

•燈體材質：優質鋁合金鑄造成型； •Body: Made of high quality cast aluminum.



- 燈體材質：優質鋁合金鑄造型；
- 透光罩：PC燈罩/玻璃燈罩；
- Body: Made of high quality cast aluminum.
- Diffuser: Polycarbonate/Glass.

- 燈體材質：優質鋁合金鑄造型；
- 透光罩：PC燈罩/玻璃燈罩；
- Body: Made of high quality cast aluminum.
- Diffuser: Polycarbonate/Glass.



- 燈體材質：優質鋁合金鑄造成型；
- 透光罩：PC燈罩/玻璃燈罩；
- Body: Made of high quality cast aluminum.
- Diffuser: Polycarbonate/Glass.



- 燈體材質：優質鋁合金鑄造成型；
- 透光罩：PC燈罩/玻璃燈罩；
- Body: Made of high quality cast aluminum.
- Diffuser: Polycarbonate/Glass.

RHS-14334



RHS-14335



RHT-13305



RHT-13310



RHS-14345

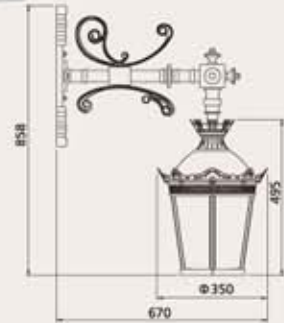

RHS-14344



RHT-13307



RHS-15755

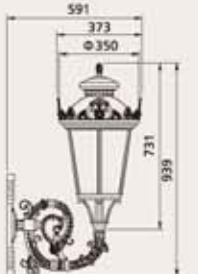

•燈體材質：優質鋁合金鑄造成型；
•透光罩：PC燈罩；
•Body: Made of high quality cast aluminum.
•Diffuser: Polycarbonate.

•燈體材質：優質鋁合金鑄造成型；
•透光罩：PC燈罩/玻璃燈罩；
•Body: Made of high quality cast aluminum.
•Diffuser: Polycarbonate/Glass.

RHT-13317

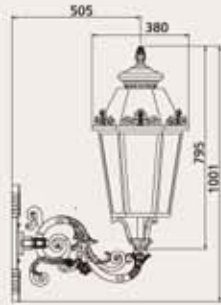

RHT-13320



RHS-15743



RHS-15744



RHT-13314

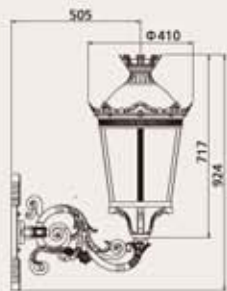

RHT-14342



RHS-15747

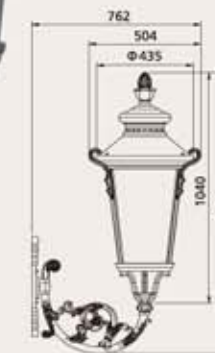

RHS-15751



• 燈體材質：優質鋁合金鑄造型； • Body: Made of high quality cast aluminum.
• 透光罩：塑料燈罩/玻璃燈罩/PC燈罩； • Diffuser: Plastic/Glass/Polycarbonate.

• 燈體材質：優質鋁合金鑄造型； • Body: Made of high quality cast aluminum.
• 透光罩：PC燈罩/玻璃燈罩； • Diffuser: Polycarbonate/Glass.



RHS-15760



RHS-15761



RHS-15756



RHS-15762



RHS-17415



RHS-17416



RHS-17417

• 燈體材質：優質鋁鎂製品；
• 透光罩：PC燈罩/玻璃燈罩；

• Body: Made of high quality cast aluminum and iron.
• Diffuser: Polycarbonate/Glass.

• 燈體材質：優質鋁鎂製品；
• 透光罩：PC燈罩/玻璃燈罩；

• Body: Made of high quality cast aluminum and iron.
• Diffuser: Polycarbonate/Glass.

RHT-13321



RHT-13322



RHT-13325



RHT-13326



RHT-13323



RHT-13324



RHT-13327



RHT-13328



•燈體材質：優質鋁合金鑄造成型；
•透光罩：PC燈罩；

•Body: Made of high quality cast aluminum.
•Diffuser: Polycarbonate.

•燈體材質：優質鋁合金鑄造成型；
•透光罩：玻璃燈罩；

•Body: Made of high quality cast aluminum.
•Diffuser: Glass.



RHS-17418

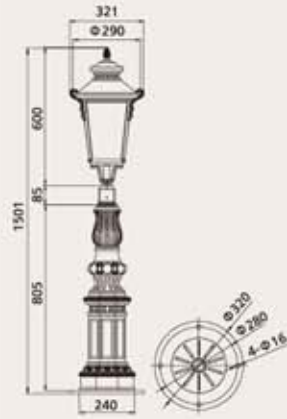

RHS-17419

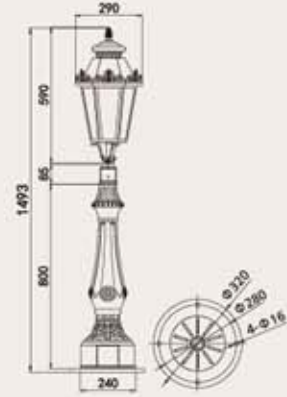

RHS-15774

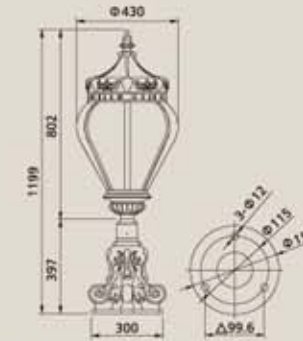

RHS-14349

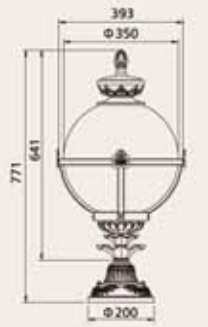

RHS-17420

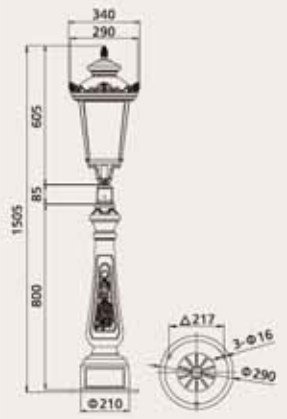

RHS-17421

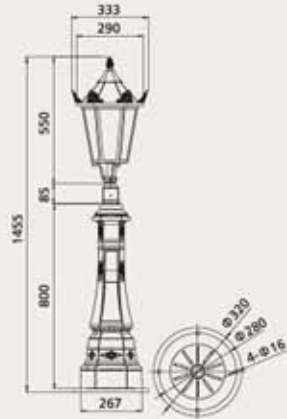

RHS-14347



•燈體材質：優質鋁合金鑄造成型；
•透光罩：PC燈罩/玻璃燈罩；

•Body: Made of high quality cast aluminum.
•Diffuser: Polycarbonate/Glass.

•燈體材質：優質鋁合金鑄造成型；
•透光罩：塑料燈罩/PC燈罩；

•Body: Made of high quality cast aluminum.
•Diffuser: Plastic/Polycarbonate.



RHT-13435 Ø250×H800/1000mm
RHT-13436 Ø400×H1500/1800mm

RHT-13437 Ø240×H800/1000mm
RHT-13438 Ø400×H1500/1800mm

RHT-13497 Ø240×H800/1000mm
RHT-13498 Ø400×H1500/1800mm



RHT-13535 Ø250×H800/1000mm
RHT-13536 Ø400×H1500/1800mm

RHT-13441 Ø240×H900/1100mm
RHT-13442 Ø400×H1600/1900mm

RHT-13445 Ø240×H800/1000mm
RHT-13446 Ø400×H1500/1800mm

