



**ITTHIRIT
NICE**
CORPORATION

**INDOOR CATALOGUE
2020-2021**



4 ช่องทางการติดต่อ EASY WAYS TO CONNECT LightTrio



WWW.LIGHTTRIO.COM

คุณสามารถเข้าไปชมแคตตาล็อก lighttrio ออนไลน์
และยังสามารถสั่งซื้อสินค้าและชำระเงินได้เลย หรือ
ดาวน์โหลดแคตตาล็อก

YOU CAN VIEW THE CATALOG ONLINE AND
LIGHTTRIO CAN ALSO ORDER AND PAY IT.
OR DOWNLOAD THE CATALOG



LINE ID : @LIGHTTRIO

ลูกค้าสามารถสอบถามข้อมูลสินค้าเพิ่มเติม และสั่งซื้อสินค้า
QUESTION & ANSWER PRODUCT ORDER

ร้านค้า ONLINE

NOC NOC



NOC NOC

SHOPEE



Shopee lighttrio

LAZADA



lazada lighttrio



WWW.FACEBOOK.COM/LIGHTTRIO

เฟสบุ๊คหน้าเพจของ LIGHTTRIO คุณสามารถ
ติดตามข่าวสาร เข้าร่วมกิจกรรม และอัปเดต
สินค้าใหม่ๆ เกี่ยวกับไลฟ์สไตล์ตลอดเวลา

PRODUCT UPDATE AND LATEST DESIGN
TREND ON LIGHTTRIO FACEBOOK



Website Lighttrio



Line Lighttrio



facebook Lighttrio



COMPANY PROFILE

ปี 2542 จัดทะเบียนชื่อ หจก.อิทธิฤทธิ์ อิเลคตริก เริ่มผลิตสินค้าประเภท ส่วนประกอบโคมไฟ ให้กับโรงงานและร้านค้า จำหน่ายโคมไฟทั่วประเทศ ด้วยเงินทุนจดทะเบียนเริ่มต้น 500,000 บาท และดำเนินกิจการเรื่อยมา จนได้เป็นตัวแทนการขายสินค้า ให้กับหลายแบรนด์ชั้นนำ เช่น Siemens, Philips ภายใต้แบรนด์ อิทธิฤทธิ์ (ITTHIRIT)

ปี 2545 ได้มีการขยายโรงงานไปต่างประเทศ และนำเข้าสินค้าจากต่างประเทศ เพื่อขยายศักยภาพต้นทุน ราคา และพัฒนาสินค้า ให้ตรงกับความต้องการของตลาด และมีการเปลี่ยนชื่อแบรนด์ จาก อิทธิฤทธิ์ (ITTHIRIT) เป็น **ไลท์ทริโอ (LIGHTTRIO)** ได้มีการขยายเข้าโครงการ อสังหาริมทรัพย์ชั้นนำในประเทศ

ปี 2557 เปลี่ยนชื่อจาก ห้างหุ้นส่วนจำกัด เป็น บริษัท อิทธิฤทธิ์ อิเลคตริก จำกัด และได้มีการนำเทคโนโลยีสมัยใหม่พวก Solar Cell ระบบ Smart Lighting เข้ามาขายให้กับโครงการมากกว่า 1000 โครงการในประเทศ

ปี 2559 ได้ย้ายที่ตั้งมาอยู่ที่ **ต.พินท้ายบรสิงห์ จ.สมุทรสาคร จนถึงปัจจุบัน** ซึ่งใช้เป็น โรงงานคลังสินค้า Showroom และสำนักงาน บนพื้นที่ประมาณ 10,000 ตรม.

ปี 2560 ได้รับ**เครื่องหมายมาตรฐานอุตสาหกรรม <มอก.1955-2551>** เป็นผู้ผลิตและจำหน่ายโคมไฟ

ปี 2561 **ได้รับมาตรฐาน ISO 9001:2015** และได้พัฒนากลุ่มสินค้าใหม่ให้สอดคล้องกับความต้องการของตลาดและอยู่ในฐานลูกค้าปัจจุบัน และจะกลุ่มลูกค้าใหม่ เป็นสินค้ากลุ่ม Smart Home และระบบ Home Automation ภายใต้แบรนด์ Homehuk Smart ได้รับการตอบรับเป็นอย่างดีจากโครงการหมู่บ้านและคอนโด

ปี 2562 **ตลอดระยะเวลา 20 กว่าปี** บริษัทฯ ได้ดำเนินธุรกิจและผลิตสินค้าออกมาทั้งหมด 6 กลุ่ม ได้แก่ **Outdoor, Indoor, Decorate, หลอดไฟ LED, โคมไฟ Solar Cell, และระบบ Smart Home** ได้มีการจำหน่ายมากกว่า 1000 โครงการ และเรายังยึดมั่นจะพัฒนาสินค้าและบริการต่อไป และได้เพิ่มเติมการบริการรับออกแบบ ติดตั้งแสงสว่าง ระบบไฟฟ้า ให้กับบ้านพักอาศัยและโครงการอีกด้วย

ปัจจุบัน บริษัทฯ ได้พัฒนาระบบการทำงานให้สอดคล้องกับเทคโนโลยีการเปลี่ยนแปลงของตลาด เศรษฐกิจ โดยเพิ่มช่องทางการจำหน่ายสินค้าบน Platform Online เพื่อเข้าถึงลูกค้าได้อย่างรวดเร็ว และปัจจุบันได้มีการเปลี่ยนชื่อบริษัท เป็น **บริษัท อิทธิฤทธิ์ โนซ์ คอร์ปอเรชั่น จำกัด** และยึดหลักนโยบายใหม่ เพื่อตอบโจทย์การทำงานให้กับลูกค้ามากยิ่งขึ้น

N NEW GEN
ก้าวทันยุคใหม่

I INNOVATION
ใส่ใจนวัตกรรม

C CUSTOMER FOCUS
ให้ความสำคัญกับลูกค้า

E ENERGY
รักษาประสิทธิภาพเต็มกำลัง

We are the light and lamp which can be suit with any LifeStyle, simple but smart, under the named **LIGHTTRIO**.



We aim to provide everyone to feel safe and convenient in the night. Making everywhere has a beautiful environment and become your best place to live when you want a house with light and also economize your cost.



Lighttrio

The brand products were various and complete. They can serve the needs of every types of our customers such as housing estate, condominium, shopping mall, skyscrapers, office building, showrooms, restaurant, industrial factory, hospital, hotel, school, university, warehouse, airports, government, and private company. Moreover, the company also provide other service for the best of our customer and design appropriate lighting system for each particular place. Our service also include designing and developing lamps for specific purpose, calculating light distribution and power, developing of economic lamp in order to serve economic trend in advance.

Made to Order

Our team of experienced designers, our expertise extends beyond designing product as we offer customization without any limitation in terms of quantity. In order to develop an ever-greater offer of products dedicated to all clients, homeowners and projects, We provide made to order service in compliance with customers' own designs using different types of high quality new materials and techniques.

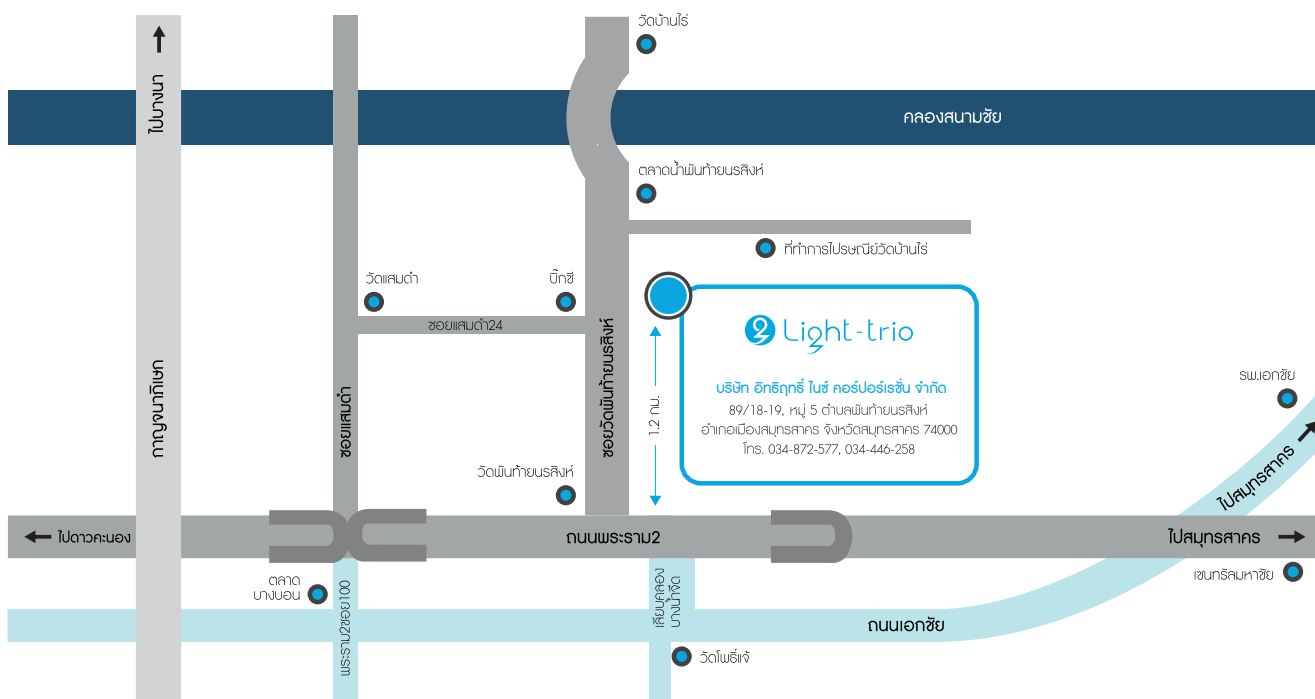

PROJECT REFERENCE

RESIDENTIAL COMPLEX

บริษัท เอพี (ไทยแลนด์) จำกัด (มหาชน)



VITTORIO

สุขุมวิท 39

THE ADDRESS

สยามราชเทวี

RHYTHM

เอกมัย, ศาสน, สุขุมวิท

Life

ศาสน, อนุศก 1-3 , ศาดพธำว 1-2, วัน ไวธศศ, สุขุมวิท 62

aspire

สุขุมวิท, อนุศก, ศาสน, เอธวธัน, งาบวงศำวณ

THE PALAZZO

พธะธาน 3, ธาษพฤกษ, จธัญศนิทวงศ

THE CLASSE

เอกมัยธานอินทรา

SOUL

ธัชดา, ศาดพธำว

บ้านกลางเมือง

พธะธาน 9, อ่อนนุช

CENTRO

มหาเจษฎาบดินทธ, จตุโชติ, อ่อนนุช, ธาษพฤกษ

THE CITY

ธาษพฤกษ, ธัชดา, ศาสน, ปันเกล้า

THE PLENO

พหลโยธิน, สุขศวิศดีพธะธาน 3

บริษัท เอสซี แอสเสท คอร์ปอเรชั่น จำกัด (มหาชน)



SANTORA

ห้วยศัน

THE CREST

สุขุมวิท 49

CENTRIC

ธัชโยธิน, ห้วยชววง, ศาสน

GRANADA

ปันเกล้า

THE GENTRY

สุขุมวิท, เอกมัย

GRAND

ศาสน, พธะธาน 9, เสธธิโย, ธาษพฤกษจธัญ, สุขุมวิทลชชช

BOULEVARD

เสธธิโย, แจงวัณน: 1-2

VENUE

เวศต์เกต, ติวณนท

PAVE

ฉะชงทธ, ธังศิต, ธานอินทรา, ปันเกล้า, พธะชชช

บริษัท แอสสิริ จำกัด (มหาชน)



THE MONUMENT

ทองหลอ

THE LINE

จตุจกธ, วงษศำววง

BASE

สุขุมวิท, พธะธาน 9, สะพณใหม่

Via

สุขุมวิท

dcondo

ก่ำพงเสณ, ธธธธศศธธ, เซียงใหม่, ศธธธธ

WISANVARDI

พธณนการ

NARASIRI

พธะธาน 2, บงน, สย 1

SETTHASIRI

แจงวัณน:, พธณนการ

บริษัท พรีเมียมเพอร์ตี เพอร์เฟก จำกัด (มหาชน)



เช่าใหญ่



หัวหิน



ประจวบ



สุขุมวิท



พระราม 4



สุขุมวิท, ศาลายา



แจ้งวัฒนะ, รัตนาธิเบศร์, พระราม 9



รัตนาธิเบศร์, ราชพฤกษ์, รามคำแหง



ราชพฤกษ์, พระราม 5, แจ้งวัฒนะ



พระราม 9, รัตนาธิเบศร์, เพชรเกษม 48



เพชรเกษม 69, รัชชิต, บางใหญ่

บริษัท พุกกษา เรียวลอสเตท จำกัด (มหาชน)



จตุจักร, กำแพง, พระราม 9



จุฬา, ทองหล่อ



สุขุมวิท, ลาดพร้าว, จรัญ



รัชชิต



รัชชิต, รามคำแหง, ศรีนครินทร์, ราชพฤกษ์



สาย 5, นครปฐม, บางคูวัด



รัชชิต, คูบอน, บางนา, พระราม 9

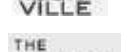

สายไหม, ปทุมธานี

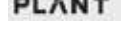

เทพารักษ์, พหลโยธิน

บริษัท แอสเซทไวส์ จำกัด (มหาชน)



สุขุมวิท 50



ห้วยขวาง



รัชดา 32



ลาดพร้าว 71, ลาดพร้าว 15, รัชดา

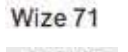

ลาดพร้าว 71



รัชชิต



ลาดพร้าว 81



ลาดพร้าว



รามอินทรา

บริษัท ออริจิ้น พร็อพเพอร์ตี้ จำกัด (มหาชน)



- PARK RIGIN** กองหล่อ, พญาไท
- KNIGHTSBRIDGE** สุขุมวิท, รัชโยธิน, สาทร
- KNIGHTSBRIDGE SPACE** รัชโยธิน, พระราม 9
- Kensington** สุขุมวิท, พหล-เกษตร, ศรีราชา, สะพานใหม่
- M SHOPPING HILL** สุขุมวิท, สะพานใหม่
- BRITANIA** ศรีนครินทร์, เมกะบางนา, หักยราชพฤกษ์

บริษัท เมเจอร์ ดีเวลลอปเม้นท์ จำกัด (มหาชน)



- METRIS** ลาดพร้าว, พระราม 9
- MAESTRO** รัชดา, สาทร, ราชเทวี
- M** กองหล่อ, จตุจักร

บริษัท ควอลิตี้ เฮ้าส์ จำกัด (มหาชน)



- Q TWILITE** ราชมงคล
- ดีศคารมย์** พระราม 2, รามคำแหง, รัตนาธิเบศร์
- ควาซ่า วิลลี่** พระราม 2, บางนา

บริษัท เรียวเอสเสก ดีเวลลอปเม้นท์ จำกัด



- PLEX BANGNA**
- CASCADE BANGNA**
- THE PRETIUM BANGNA**

บริษัท เซ็ลทรัลพัฒนา จำกัด (มหาชน)



- ESCENT** อุดรธานี, ขอนแก่น, เชียงใหม่, นครราชสีมา, เชียงราย
- Phyll** พหลโยธิน
- NIYHAM** บรมราชธานี

บริษัท ยูนิตี้ ดีเวลลอปเม้นท์ จำกัด



- MAZARINE**
- CIELA**
- LAPS**

บริษัท อนันดา ดีเวลลอปเม้นท์ จำกัด (มหาชน)



- ASHTON**
- UNIO**
- ELIO DEL WEST**

บริษัท ชิวากัย จำกัด (มหาชน)



- HALLMARK** งามวงศ์วาน, แจ้งวัฒนะ
- CHEWA HOME** สุขสวัสดิ์, ลำลูกกา
- CHEWAWAN** ปิ่นเกล้า-สาทร, รัชดา

บริษัท ดี เออเบิล พร็อพเพอร์ตี้ จำกัด



- ACQUA**
- S&V**
- AERAS**

บริษัท เสนาดีเวลลอปเม้นท์ จำกัด (มหาชน)



- เนอ**

บริษัท อัลติจูด ดีเวลลอปเม้นท์ จำกัด



ALTITUDE
PROVE

เกษตรนวนิน, พระราม 9

ALTITUDE
UNICORN
Bathorn - The Place

ตลาดพลู

บริษัท อออล์ อินสไพร์ ดีเวลลอปเม้นท์ จำกัด (มหาชน)



RISE

พระราม 9

THE EXCEL

สุขุมวิท, รัชดา, GROOVE

บริษัท ปริญญาสิริ จำกัด (มหาชน)



Zerene

ซีริน พระราม2-ท่าข้าม

iconature

อีคอนเนเจอร์ พระราม2-เทียนทะเล

forêt

เฟอร์เร่ ลำลูกกา-คลอง 5

CORAZON
PRACHINWIT

โคราซอน ประชาชื่น

city sense

ซิตีเซนส์ พระราม2-ท่าข้าม, ซีตี้เซนส์ รัชดา

zelle
RATTANATHIWI

เซล รัตนาธิเบศ, เซล รัตนาธิเบศ 2, เซล ศาลาภา

HOTEL

บริษัท ดี เอราวัณ กรุ๊ป จำกัด (มหาชน)



Holiday Inn

Holiday Inn

บริษัท ออริจิ้น วัน ทงหล่อ จำกัด



STAYBRIDGE SUITES

ทงหล่อ, ศรีราชา

IDENTITY YOUR STYLE

INDOOR CONTENT

PAGE

UVC SERIES	1-14
LED SERIES	1-14
DOWNLIGHT	1-64
FLUORESCENT	1-19
TRACKLIGHT	1-8
CEILING LAMP	1-7
EMERGENCY	1-8
DECORATE	1-18



Change Your Light Keep COVID-19 at Bay



Traditional LED lighting



59S SunClean™ Lighting

59S SunClean™ Lighting is blazing the trail in integrating UV-C disinfection into LED lighting. This series of unprecedented health-protecting lighting products provide the three-fold usage of surface disinfection, air-cleaning, and illumination. Boasting a disinfection rate up to 99.9%*—with no excess radiation, no ozone produced, and no residual chemicals—and a military-grade radar sensor to detect anyone around, SunClean is designed to keep people safe and healthy.

Just change the light!

Easily prevent contamination !

Ensure the safety of family members and employees.



Restaurants



Bars



Toilets



Meeting rooms



Elevators



Gyms

Applications: restaurants, bars, barber shops, restrooms, meeting rooms, banks, gyms, elevators, hotels, clinics, nursing homes, convenience stores, supermarkets, retail stores, entertainment venues, etc.

The measurement standard of SunClean™ Lighting for killing germs



广东省微生物分析检测中心
GUANGDONG DETECTION CENTER OF MICROBIOLOGY
分析检测结果
ANALYSIS AND TEST RESULT

报告编号 (Report No.): 2020SP040402D
1. 作用距离 Action distance: 50cm
2. 测试结果 Results:

Test organisms	Action Time	Test group	Average cfu of testing groups (cfu/10 piece)	Average cfu of positive controls (cfu/10 piece)	Sterilization logarithm (KL)	Sterilization rate (%)
<i>Staphylococcus aureus</i> ATCC 6538	165s	1	<5	3.1×10^7	>5.70	>99.99
		2	<5	3.0×10^7	>5.70	>99.99
		3	<5	3.2×10^7	>5.81	>99.99
	Average				>5.70	>99.99
	80s	1	<5	3.1×10^7	>5.70	>99.99
		2	<5	3.0×10^7	>5.70	>99.99
		3	<5	3.2×10^7	>5.81	>99.99
	Average				>5.70	>99.99
	45s	1	20	3.1×10^7	5.10	99.99
		2	10	3.0×10^7	5.48	99.99
		3	25	3.2×10^7	5.11	99.99
	Average				5.26	99.99
	40s	1	2.6×10^7	3.1×10^7	4.08	99.99
		2	2.3×10^7	3.0×10^7	4.12	99.99
		3	2.9×10^7	3.2×10^7	4.05	99.99
	Average				4.08	99.99
	40s	1	4.2×10^7	3.1×10^7	3.87	99.99
		2	3.7×10^7	3.0×10^7	3.91	99.99
		3	4.4×10^7	3.2×10^7	3.87	99.99
	Average				3.88	99.99
	32s	1	8.3×10^7	3.1×10^7	3.30	99.97
		2	9.0×10^7	3.0×10^7	3.53	99.97
		3	9.5×10^7	3.2×10^7	3.53	99.97
	Average				3.54	99.97
25s	1	2.4×10^7	3.1×10^7	3.11	99.92	
	2	2.8×10^7	3.0×10^7	3.03	99.91	
	3	2.7×10^7	3.2×10^7	3.08	99.92	
Average				3.07	99.91	

(续下页, Continued on the next page)
第 3 页 共 5 页

广东省微生物分析检测中心
GUANGDONG DETECTION CENTER OF MICROBIOLOGY
分析检测结果
ANALYSIS AND TEST RESULT

报告编号 (Report No.): 2020SP040401D
1. 作用距离 Action distance: 150cm
2. 测试结果 Results:

Test organisms	Action Time	Test group	Average cfu of testing groups (cfu/10 piece)	Average cfu of positive controls (cfu/10 piece)	Sterilization logarithm (KL)	Sterilization rate (%)
<i>Staphylococcus aureus</i> ATCC 6538	5000s	1	<5	3.1×10^7	>5.70	>99.99
		2	<5	3.0×10^7	>5.70	>99.99
		3	<5	3.2×10^7	>5.81	>99.99
	Average				>5.70	>99.99
	2500s	1	<5	3.1×10^7	>5.70	>99.99
		2	<5	3.0×10^7	>5.70	>99.99
		3	<5	3.2×10^7	>5.81	>99.99
	Average				>5.70	>99.99
	2000s	1	<5	3.1×10^7	>5.70	>99.99
		2	<5	3.0×10^7	>5.70	>99.99
		3	<5	3.2×10^7	>5.81	>99.99
	Average				>5.70	>99.99
	1500s	1	4.5×10^7	2.4×10^7	3.84	99.99
		2	3.7×10^7	2.7×10^7	3.91	99.99
		3	4.3×10^7	2.8×10^7	3.88	99.99
	Average				3.88	99.99
	1250s	1	6.0×10^7	2.4×10^7	3.71	99.98
		2	5.5×10^7	2.7×10^7	3.74	99.98
		3	6.5×10^7	2.8×10^7	3.70	99.98
	Average				3.72	99.98
	1000s	1	8.0×10^7	2.4×10^7	3.59	99.97
		2	7.5×10^7	2.7×10^7	3.60	99.98
		3	8.0×10^7	2.8×10^7	3.61	99.98
	Average				3.60	99.98
750s	1	1.2×10^8	2.4×10^7	3.41	99.96	
	2	1.1×10^8	2.7×10^7	3.44	99.96	
	3	1.3×10^8	2.8×10^7	3.40	99.96	
Average				3.42	99.96	

(续下页, Continued on the next page)
第 3 页 共 5 页



广东省微生物分析检测中心
GUANGDONG DETECTION CENTER OF MICROBIOLOGY
分析检测结果
ANALYSIS AND TEST RESULT

报告编号 (Report No.): 2020SP040401D
1. 作用距离 Action distance: 150cm
2. 测试结果 Results:

Test organisms	Action Time	Test group	Average cfu of testing groups (cfu/10 piece)	Average cfu of positive controls (cfu/10 piece)	Sterilization logarithm (KL)	Sterilization rate (%)
<i>Escherichia coli</i> 8099	5000s	1	<5	2.4×10^7	>5.68	>99.99
		2	<5	2.7×10^7	>5.73	>99.99
		3	<5	2.8×10^7	>5.75	>99.99
	Average				>5.72	>99.99
	2500s	1	<5	2.4×10^7	>5.68	>99.99
		2	<5	2.7×10^7	>5.73	>99.99
		3	<5	2.8×10^7	>5.75	>99.99
	Average				>5.72	>99.99
	2000s	1	<5	2.4×10^7	>5.68	>99.99
		2	<5	2.7×10^7	>5.73	>99.99
		3	<5	2.8×10^7	>5.75	>99.99
	Average				>5.72	>99.99
	1500s	1	33	2.4×10^7	4.84	99.99
		2	33	2.7×10^7	4.89	99.99
		3	45	2.8×10^7	4.80	99.99
	Average				4.84	99.99
	1250s	1	3.2×10^7	2.4×10^7	3.87	99.99
		2	3.6×10^7	2.7×10^7	3.87	99.99
		3	3.9×10^7	2.8×10^7	3.86	99.99
	Average				3.87	99.99
	1000s	1	5.0×10^7	2.4×10^7	3.68	99.99
		2	5.5×10^7	2.7×10^7	3.69	99.98
		3	5.5×10^7	2.8×10^7	3.71	99.98
	Average				3.69	99.98
750s	1	9.0×10^7	2.4×10^7	3.43	99.96	
	2	9.5×10^7	2.7×10^7	3.45	99.96	
	3	1.0×10^8	2.8×10^7	3.45	99.96	
Average				3.44	99.96	

(续下页, Continued on the next page)
第 3 页 共 5 页

广东省微生物分析检测中心
GUANGDONG DETECTION CENTER OF MICROBIOLOGY
分析检测结果
ANALYSIS AND TEST RESULT

报告编号 (Report No.): 2020SP040401D
1. 作用距离 Action distance: 40cm
2. 测试结果 Results:

Test organisms	Action Time	Test group	Average cfu of testing groups (cfu/10 piece)	Average cfu of positive controls (cfu/10 piece)	Sterilization logarithm (KL)	Sterilization rate (%)
<i>Escherichia coli</i> 8099	165s	1	<5	2.4×10^7	>5.68	>99.99
		2	<5	2.7×10^7	>5.73	>99.99
		3	<5	2.8×10^7	>5.75	>99.99
	Average				>5.72	>99.99
	80s	1	<5	2.4×10^7	>5.68	>99.99
		2	<5	2.7×10^7	>5.73	>99.99
		3	<5	2.8×10^7	>5.75	>99.99
	Average				>5.72	>99.99
	45s	1	<5	2.4×10^7	>5.68	>99.99
		2	<5	2.7×10^7	>5.73	>99.99
		3	<5	2.8×10^7	>5.75	>99.99
	Average				>5.72	>99.99
	40s	1	45	2.4×10^7	4.73	99.99
		2	45	2.7×10^7	4.62	99.99
		3	80	2.8×10^7	4.55	99.99
	Average				4.63	99.99
	40s	1	1.8×10^8	2.4×10^7	4.12	99.99
		2	1.9×10^8	2.7×10^7	4.15	99.99
		3	2.1×10^8	2.8×10^7	4.13	99.99
	Average				4.13	99.99
	32s	1	2.5×10^8	2.4×10^7	3.90	99.99
		2	2.7×10^8	2.7×10^7	4.00	99.99
		3	2.8×10^8	2.8×10^7	4.00	99.99
	Average				3.90	99.99
25s	1	3.6×10^8	2.4×10^7	3.82	99.99	
	2	3.8×10^8	2.7×10^7	3.85	99.99	
	3	3.8×10^8	2.8×10^7	3.87	99.99	
Average				3.83	99.99	

(续下页, Continued on the next page)
第 3 页 共 5 页

*Representative colonies: S. aureus, E.coli they are the standard representative colonies in the UV-C disinfection tests of the WHO, representing 99.9% of bacterial characteristics.

Under normal circumstances, the WHO stipulates that it is necessary to pass the test of these two kinds of bacteria, so that the disinfection ability of the UV equipment can be determined to be qualified.

What is SunClean

Intelligent, Automatic Disinfection, Air-Cleaning, and Lighting. 3-in-1.



3-in-1

Intelligent, Automatic Disinfection, Air-Cleaning, and Lighting.

Simple Replacement

Just Change Your Light.

Intelligent Operation

Illumination while you're there, disinfection when you leave.

Safe and Reliable

Military-grade radar and radar self-diagnosis. No chemical residue.

Keep Spaces Free of COVID-19

No extra manpower. Highly cost-effective.

Minimize Infection Spread

Disinfection occurs immediately after people leave the room.

SunClean™ Downlight

Intelligent, Automatic Disinfection, Air-Cleaning, and Lighting. 3-in-1.



LED Downlight 4"



LED Downlight 5"



LED Downlight 6"

Change by

Change by

Change by



4" Size: ϕ 149mm

UVC-D-PN014/14



5" Size: ϕ 174mm

UVC-D-PN017/18



6" Size: ϕ 184mm

UVC-D-PN018/18



Radar



Power box



Kills up to 99.9% of all Germs



Military-grade radar sensor ensures safe use

	4" Size: $\phi 149\text{mm}$	5" Size: $\phi 174\text{mm}$	6" Size: $\phi 184\text{mm}$
Lighting Specifications	UVC-D-PN014/18	UVC-D-PN017/18	UVC-D-PN018/18
Power	14W	18W	18W
Brightness	>1190 lm	> 1530 lm	> 1530 lm
Color Temperature	3000K/4000K/6000K	3000K/4000K/6000K	3000K/4000K/6000K
Color Chromaticity	SDCM<5	SDCM<5	SDCM<5
CRI	>80	>80	>80
Lamp Lifespan	>20,000 hrs	>20,000 hrs	>20,000 hrs
UV Specifications			
Diode Type	UV-C LED	UV-C LED	UV-C LED
Power	18W	18W	20W
UV Energy	180mW	180mW	200mW
Disinfection Area	$3 \times 3\text{m}(9\text{m})^2$	$3 \times 3\text{m}(9\text{m})^2$	$3 \times 3\text{m}(9\text{m})^2$
Disinfection Modes	20 min Automatic mode, 2 hrs Intensive mode	20 min Automatic mode, 2 hrs Intensive mode	20 min Automatic mode, 2 hrs Intensive mode
Detection Sensor	5.8G	5.8G	5.8G
Beam Radius	100°	100°	100°
Wavelength	260-285nm	260-285nm	260-285nm
Lamp Lifespan	>10,000 hrs	>10,000 hrs	>10,000 hrs
Power Specifications			
Voltage	100-240V AC	100-240V AC	100-240V AC
Power	50 / 60Hz	50 / 60Hz	50 / 60Hz
Adjustable Color Temperature	No	No	No
Operation Modes	Manual switch mode / radar sensor automatic mode	Manual switch mode / radar sensor automatic mode	Manual switch mode / radar sensor automatic mode
Physical Specifications			
Lamp Body Materials	Aluminum alloy and plastic	Aluminum alloy and plastic	Aluminum alloy and plastic
Lamp Body Color	Dark gray and white	Dark gray and white	Dark gray and white
Lamp Size	$\phi 149 \times 35\text{mm}$	$\phi 174 \times 35\text{mm}$	$\phi 184 \times 35\text{mm}$
Required Hole Size	$\phi 130-140\text{mm}$	$\phi 155-165\text{mm}$	$\phi 165-175\text{mm}$
Lamp Weight	Main body: 325g (11.5oz) + LED driver: 85g (3oz)	Main body: 405g (11.5oz) + LED driver: 85g (3oz)	Main body: 480g + LED driver: 85g (3oz)
Operating Temperature	$-10^\circ\text{C} \sim 50^\circ\text{C}$ ($14^\circ\text{F} \sim 122^\circ\text{F}$)	$-10^\circ\text{C} \sim 50^\circ\text{C}$ ($14^\circ\text{F} \sim 122^\circ\text{F}$)	$-10^\circ\text{C} \sim 50^\circ\text{C}$ ($14^\circ\text{F} \sim 122^\circ\text{F}$)
Certifications and Warranty			
Certifications	FCC, CE	FCC, CE	FCC, CE
Warranty	2 Years	2 Years	2 Years

SunClean™ Panel Light

Intelligent, Automatic Disinfection, Air-Cleaning, and Lighting. 3-in-1.



Size: Φ 600x600mm

Change by



Size: Φ 600x600mm

UVC-F-6060/48/60

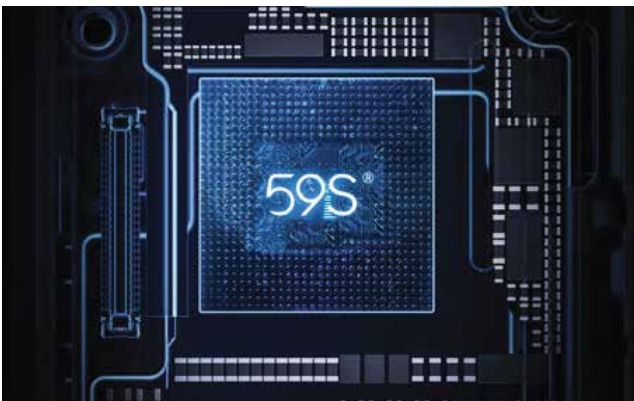

Radar

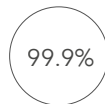

Kills up to 99.9%
of all Germs



Military-gradar radar
sensor ensures safe use

Size: ϕ 600x600mm

Lighting Specifications	UVC-F-6060/48/60
Power	48W
Brightness	>4080 lm
Lighting Color	Daylight white
Color Temperature	6000K
Color Chromaticity	SDCM<5
CRI	>80
Lamp Lifespan	>20,000 hrs
UV Specifications	
Diode Type	UV-C LED
Power	24W
Total UV Energy	240mW
Sterilization Area	3 x 3m(9m) ²
Disinfection Modes	20 min Automatic mode, 2 hrs Intensive mode
Detection Sensor	5.8G
Beam Radius	100°
Wavelength	260-285nm
Lamp Lifespan	>10,000 hrs
Power Specifications	
Voltage	100-240V AC
Power	50 / 60Hz
Adjustable Color Temperature	No
Operation Modes	Manual switch mode / radar sensor automatic mode
Physical Specifications	
Lamp Body Materials	Alluminum alloy ad stainless iron
Lamp Body Color	White
Lamp Size	ϕ 595x595x30.8mm
Lamp Weight	1820g
Operating Temperature	-10°C~50°C (14°F-122°F)
Certifications and Warranty	
Certifications	FCC, CE
Warranty	2 Years

SunClean™ Panel Light

Intelligent, Automatic Disinfection, Air-Cleaning, and Lighting. 3-in-1.

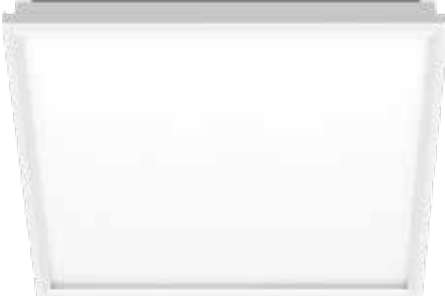

Size: Ø 300x300mm

Change by



Size: Ø 300x300mm

UVC-F-3030/24/60

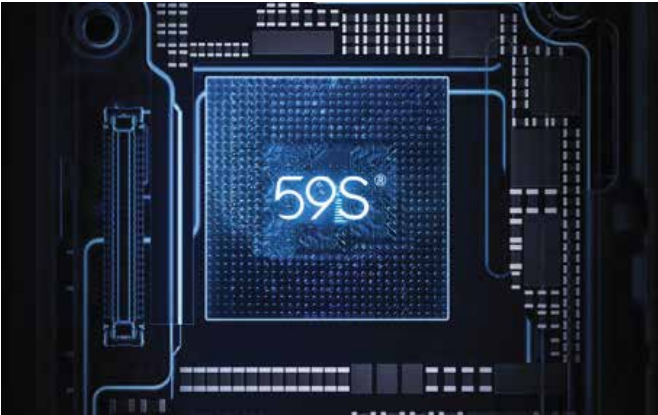

Radar

99.9%

Kills up to 99.9% of all Germs



Military-gradar radar sensor ensures safe use

Size: Φ 300x300mm

Lighting Specifications	UVC-F-3030/24/60
Power	24W
Brightness	>2040 lm
Lighting Color	Daylight white
Color Temperature	6000K
Color Chromaticity	SDCM<5
CRI	>80
Lamp Lifespan	>20,000 hrs
UV Specifications	
Diode Type	UV-C LED
Power	18W
Total UV Energy	180mW
Sterilization Area	3 x 3m(9m) ²
Disinfection Modes	20 min Automatic mode, 2 hrs Intensive mode
Detection Sensor	5.8G
Beam Radius	100°
Wavelength	260-285nm
Lamp Lifespan	>10,000 hrs
Power Specifications	
Voltage	100-240V AC
Power	50 / 60Hz
Adjustable Color Temperature	No
Operation Modes	Manual switch mode / radar sensor automatic mode
Physical Specifications	
Lamp Body Materials	Aluminum alloy ad stainless iron
Lamp Body Color	White
Lamp Size	Φ 295x295x30.8mm
Lamp Weight	670g
Operating Temperature	-10°C~50°C (14°F-122°F)
Certifications and Warranty	
Certifications	FCC, CE
Warranty	2 Years

SunClean™ Panel Light

Intelligent, Automatic Disinfection, Air-Cleaning, and Lighting. 3-in-1.



Change by



Size: Φ 300x600mm

Size: Φ 300x600mm

UVC-F-3060/30/60



Change by



Size: Φ 300x1200mm

Size: Φ 300x1200mm

UVC-F-30120/48/60

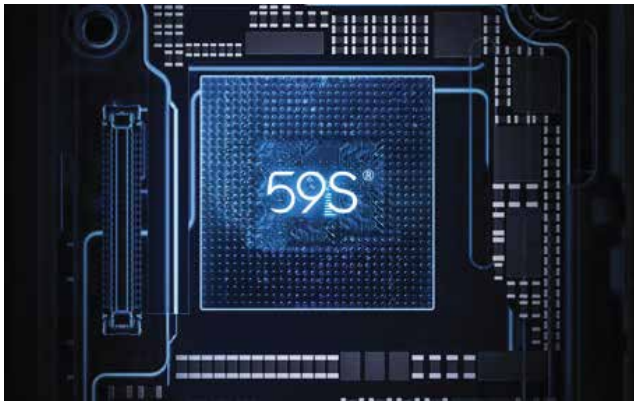

Radar

99.9%

Kills up to 99.9% of all Germs



Military-gradar radar sensor ensures safe use

	Size: Φ 300x600mm	Size: Φ 300x1200mm
Lighting Specifications	UVC-F-3060/30/60	UVC-F-30120/48/60
Power	30W	48W
Brightness	>2550 lm	>4080 lm
Lighting Color	Daylight white	Daylight white
Color Temperature	6000K	6000K
Color Chromaticity	SDCM<5	SDCM<5
CRI	>80	>80
Lamp Lifespan	>20,000 hrs	>20,000 hrs
UV Specifications		
Diode Type	UV-C LED	UV-C LED
Power	18W	24W
Total UV Energy	180mW	240mW
Sterilization Area	3 x 3m(9m) ²	3 x 3m(9m) ²
Disinfection Modes	20 min Automatic mode, 2 hrs Intensive mode	20 min Automatic mode, 2 hrs Intensive mode
Detection Sensor	5.8G	5.8G
Beam Radius	100°	100°
Wavelength	260-285nm	260-285nm
Lamp Lifespan	>10,000 hrs	>10,000 hrs
Power Specifications		
Voltage	100-240V AC	100-240V AC
Power	50 / 60Hz	50 / 60Hz
Adjustable Color Temperature	No	No
Operation Modes	Manual switch mode / radar sensor automatic mode	Manual switch mode / radar sensor automatic mode
Physical Specifications		
Lamp Body Materials	Alluminum alloy and stainless iron	Alluminum alloy and stainless iron
Lamp Body Color	White	White
Lamp Size	Φ 300x600mm	Φ 300x1200mm
Lamp Weight	1145g (40.4oz)	2150g
Operating Temperature	-10°C~50°C (14°F-122°F)	-10°C~50°C (14°F-122°F)
Certifications and Warranty		
Certifications	FCC, CE	FCC, CE
Warranty	2 Years	2 Years

SunClean™ Ceiling Light

Intelligent, Automatic Disinfection, Air-Cleaning, and Lighting. 3-in-1.



LED Ceiling light

Change by



Size: Φ 180x53.3mm

UVC-C-18/16/65

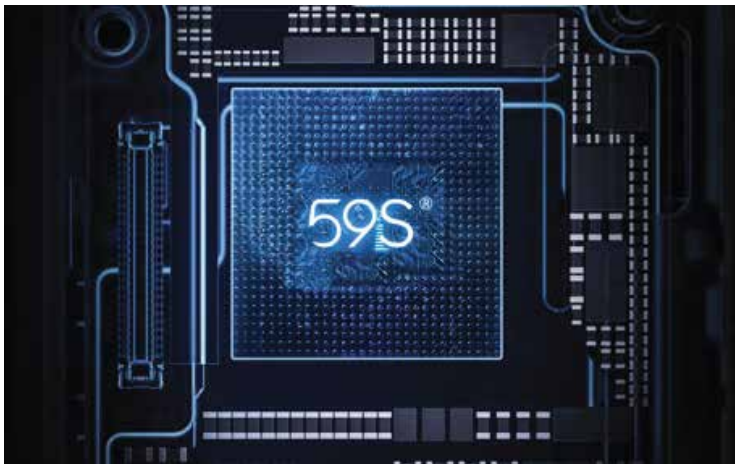

Radar



Kills up to 99.9%
of all Germs



20mins
Auto disinfection



Military-radar radar
sensor ensures safe use



30W disinfection
16W lighting



มาพร้อมสายเสียบ



Size: Φ 180x53.3mm

Lighting Specifications	UVC-C-18/16/65
Power	16W
Brightness	Max. 3000 lm
Color Temperature	6500K
Color Chromaticity	SDCM<5
CRI	>80
Lamp Lifespan	>20,000 hrs
UV Specifications	
Diode Type	UV-C LED
Power	35W
Total UV Energy	300mW
Sterilization Area	4 x 4m(16m) ²
Disinfection Modes	10 min Automatic mode, 2 hrs Intensive mode
Detection Sensor	5.8G
Beam Radius	100°
Wavelength	260-285nm
Lamp Lifespan	>10,000 hrs
Power Specifications	
Voltage	100-240V AC
Power	50 / 60Hz
Adjustable Color Temperature	No
Operation Modes	Manual switch mode / radar sensor automatic mode
Physical Specifications	
Lamp Body Materials	Plastic
Lamp Body Color	White
Lamp Size	Φ 180 x 53.3mm (7.1 x 2.1in)
Lamp Weight	475g (16.75oz)
Operating Temperature	-10~50°C (14-122°F)
Certifications and Warranty	
Certifications	FCC, CE
Warranty	2 Years

STRIPLIGHT Collection



Description LED Strip Light

LED-RB20/4.8/24

Luminous : 500/m
 LES Strip Light : 4.8W
 IP Grade : IP20
 Transformer : 24VDC

1,200.-/10m.



Description LED Strip Light

LED-RB20/9.6/24

Luminous : 1200/m
 LES Strip Light : 9.6W
 IP Grade : IP20
 Transformer : 24VDC

1,600.-/10m.



Description LED Strip Light

LED-RB20/13/24

Luminous : 1625/m
 LES Strip Light : 13W
 IP Grade : IP20
 Transformer : 24VDC

1,900.-/10m.

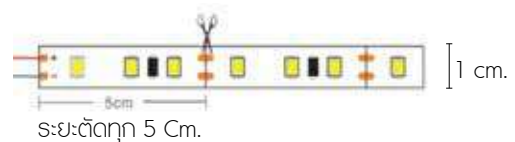
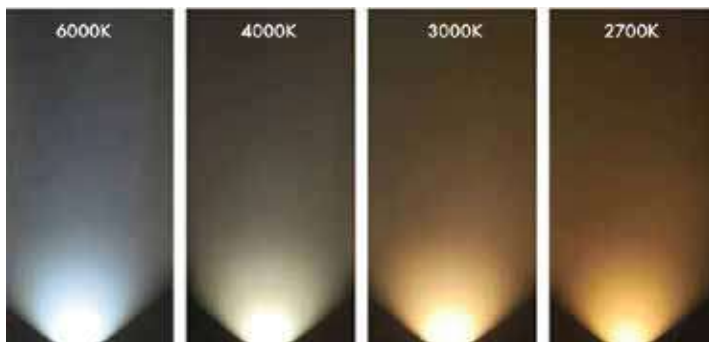

STRIPLIGHT Collection



6W



12W

คุณสมบัติ

- ใช้ไฟ DC 12V
- องศาการกระจายแสงกว้างถึง 120
- ระยะตัดทุกๆ 5 ซม.
- IP 20
- เหมาะสำหรับการตกแต่งภายใน
- ต้องใช้งานคู่กับ LED Driver 12 Vdc

ประโยชน์

- การติดตั้งทำได้ง่าย และปลอดภัย
- เพิ่มสีสันและมีมิติตามสถานที่ต่างๆ
- ประยุกต์ใช้งานได้หลากหลายตามความต้องการ

รายละเอียดสินค้า	ระยะ/ม้วน	Power Factor	Lumen (lm)	อายุการใช้งาน (ชั่วโมง)
OPL-RB/2835/24 12V 6W/m 2400K	5m.	0.9	580	15000
OPL-RB/2835/27 12V 6W/m 2700K	5m.	0.9	620	15000
OPL-RB/2835/30 12V 6W/m 3000K	5m.	0.9	650	15000
OPL-RB/2835/40 12V 6W/m 4000K	5m.	0.9	680	15000
OPL/RB/2835/65 12V 6W/m 6500K	5m.	0.9	690	15000
OPL/RB12/2835/30 12V 12W/m 3000K	5m.	0.9	1200	15000
OPL/RB12/2835/65 12V 12W/m 6500K	5m.	0.9	1200	15000

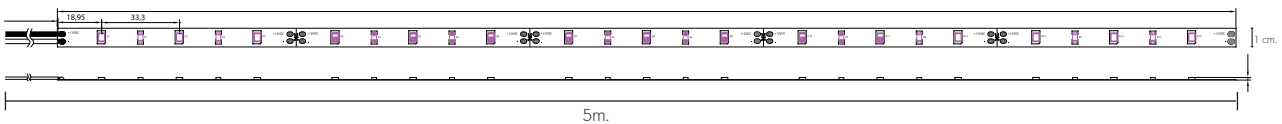

การใช้งานเหมาะสำหรับ

- ที่พักอาศัย
- โรงแรม
- ร้านค้าทั่วไป
- ห้างสรรพสินค้า
- สำนักงาน



STRIPLIGHT Collection

Description LED Strip Light

LED-RB68/8/12

Luminous : 800/m

LES Strip Light : 8W

IP Grade : IP68 (ใช้ภายนอก)

Transformer : 12VDC

2,000.-/5m.

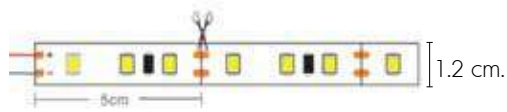

ระยะตัดทุก 5 Cm.

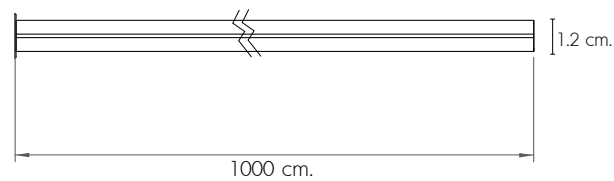

Description LED Strip Light

LED-RBU68/12/24/30

Color Temperature : 3000 K

Luminous : 1200/m

LES Strip Light : 12W

IP Grade : IP68 (ใช้ภายนอก)

Transformer : 24VDC

14,000.-/10m.



LED-RBU68-BAR1

400.-/1m.

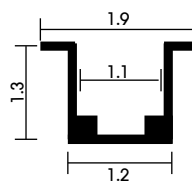

ALUMINIUM PROFILE



LED-RB-BAR-15
200.-/1m.
มีพลาสติกปิดราง

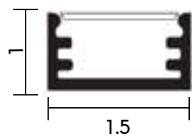

LED-RB-BAR-R15
300.-/1m.
มีพลาสติกปิดราง

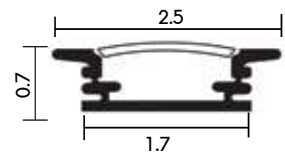

LED-RB-BAR-H35
1,500.-/2m.
มีพลาสติกปิดราง + สลิ่ง

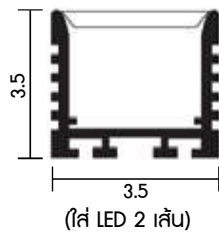

LED-RB-BAR-R35
1,200.-/2m.

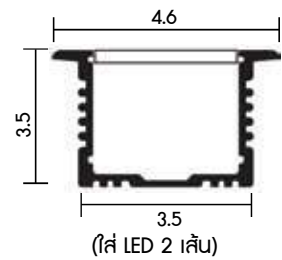

LED-RB-BAR45
200.-/1m.
มีพลาสติกปิดราง
จำนวน 45 องศา

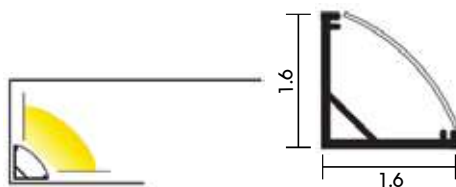



POWER SUPPLY & SWITCHING

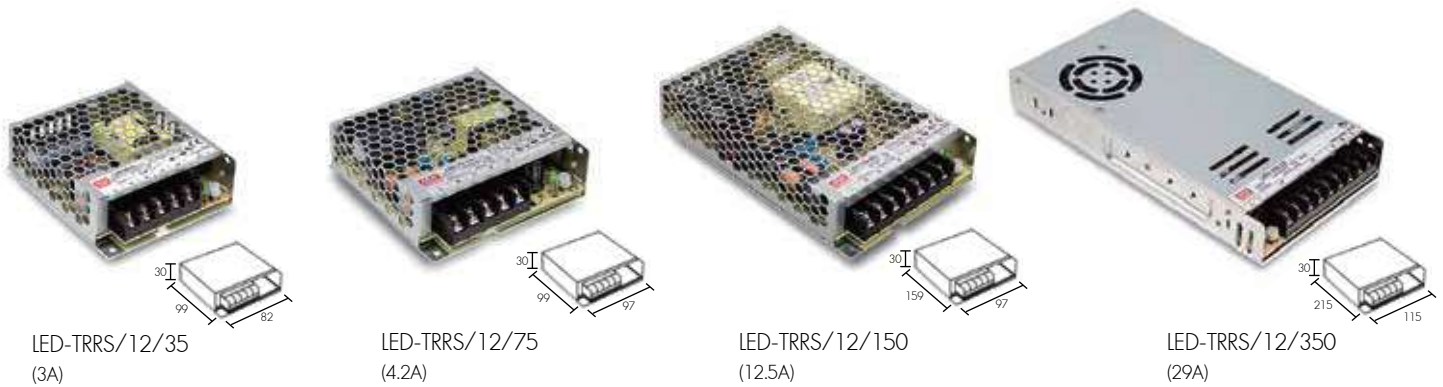

IP20 12v

ID CODE	Input Voltage	Out Voltage	Output Current	Power Frequency	Output Power	Dimension (mm) L x W x H
LED-TRRS/12/35/MW	AC 85 - 264V	DC 12V	3A	47-63Hz	36w	99 x 82 x 30
LED-TRRS/12/50/MW	AC 85 - 264V	DC 12V	4.2A	47-63Hz	50.4w	99 x 82 x 30
LED-TRRS/12/75/MW	AC 85 - 264V	DC 12V	6A	47-63Hz	72w	99 x 97 x 30
LED-TRRS/12/100/MW	AC 85 - 264V	DC 12V	8.5A	47-63Hz	102w	129 x 97 x 30
LED-TRRS/12/150/MW	AC 85 - 132V	DC 12V	12.5A	47-63Hz	150w	159 x 97 x 30
LED-TRRS/12/200/MW	AC 90 - 132V	DC 12V	17A	47-63Hz	204w	215 x 115 x 30
LED-TRRS/12/350/MW	AC 90 - 132V	DC 12V	29A	47-63Hz	348w	215 x 115 x 30

IP20 24v

ID CODE	Input Voltage	Out Voltage	Output Current	Power Frequency	Output Power	Dimension (mm) L x W x H
LED-TRRS/24/35/MW	AC 85 - 264V	DC 24V	1.5A	47-63Hz	36w	99 x 82 x 30
LED-TRRS/24/50/MW	AC 85 - 264V	DC 24V	2.2A	47-63Hz	52.8w	99 x 82 x 30
LED-TRRS/24/75/MW	AC 85 - 264V	DC 24V	3.2A	47-63Hz	76.8w	99 x 97 x 30
LED-TRRS/24/100/MW	AC 85 - 264V	DC 24V	4.5A	47-63Hz	108w	129 x 97 x 30
LED-TRRS/24/150/MW	AC 85 - 132V	DC 24V	6.5A	47-63Hz	156w	159 x 97 x 30
LED-TRRS/24/200/MW	AC 90 - 132V	DC 24V	8.8A	47-63Hz	211.2w	215 x 115 x 30
LED-TRRS/24/350/MW	AC 90 - 132V	DC 24V	14.6A	47-63Hz	350.4w	215 x 115 x 30

STRIPLIGHT Collection



- Warm White 3000K
- Cool White 4000K
- Day light 6000K

คุณสมบัติ

- ใช้ Chip 5050 คุณภาพสูง
- ภายในใช้ไส้ทองแดงอย่างดี
- ห่อหุ้มด้วย เรซิน และ PVC อย่างดี
- ระดับการกันน้ำกันฝุ่น IP65

ประโยชน์

- แสงที่ออกมาเป็นระเบียบและสว่างกว่ายี่ห้อทั่วไป
- สีไม่เพี้ยน
- ให้แสงสว่างคงที่ตลอดอายุการใช้งาน
- ให้ความยืดหยุ่นสูง เหมาะกับการใช้งานในหลายสถานที่

รายละเอียดสินค้า	จำนวน	Power Factor	Lumen (lm)	อายุการใช้งาน (ชั่วโมง)
OPL-RB220/30 220V 8W/m 3000K	1m.	0.9	350	12000
OPL-RB220/40 220V 8W/m 4000K	1m.	0.9	350	12000
OPL-RB220/60 220V 8W/m 6000K	1m.	0.9	350	12000
OPL-RB220/RD 220V 8W/m สีแดง	1m.	0.9	350	12000
OPL-RB220/BL 220V 8W/m สีฟ้า	1m.	0.9	350	12000
OPL-RB220/GN 220V 8W/m สีเขียว	1m.	0.9	350	12000
OPL-RB220/YM 220V 8W/m สีเหลือง	1m.	0.9	350	12000

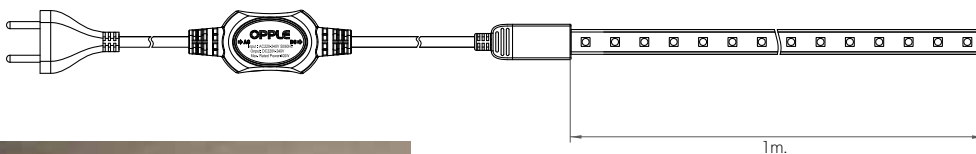

Accessory Information

LED Strip 5050 Accessory Package (ปลั๊กไฟ + อุปกรณ์)

- OPL-RB220-A1
- OPL-RB220-CAM

หัวจ่าย+จุดปิด+แคมปรับ

การใช้งานเหมาะสำหรับ

- ที่พักอาศัย
- โรงแรม
- ร้านค้าทั่วไป
- ห้างสรรพสินค้า
- สำนักงาน



LED TUBE BETTERN LED T5



DIMMER

OPL-FAT5-MF4/30
OPL-FAT5-MF4/40
OPL-FAT5-MF4/57

OPL-FAT5-MF7/30
OPL-FAT5-MF7/40
OPL-FAT5-MF7/57

OPL-FAT5-MF14/30
OPL-FAT5-MF14/40
OPL-FAT5-MF14/57

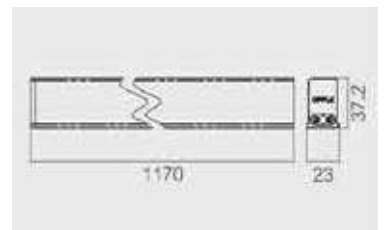
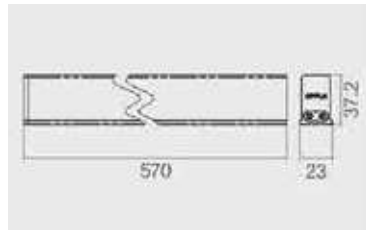
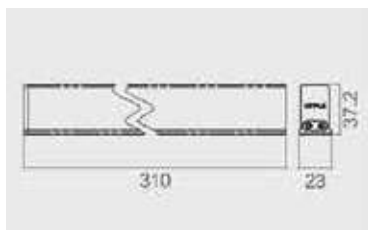

- Warm White 3000K
- Cool White 4000K
- Day Light 5700K

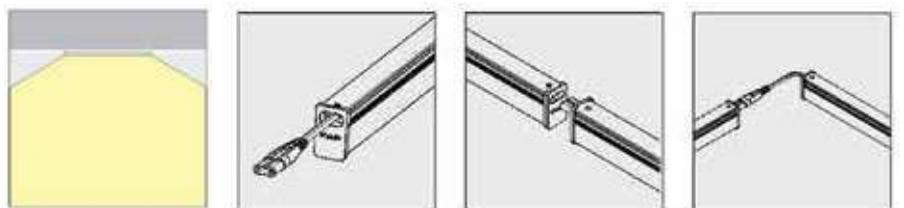

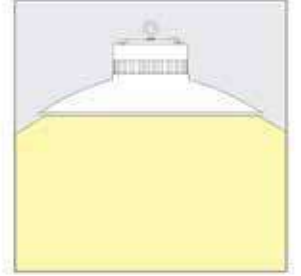
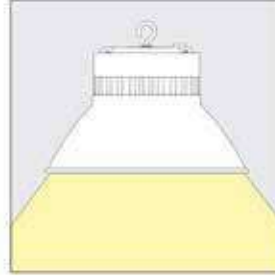
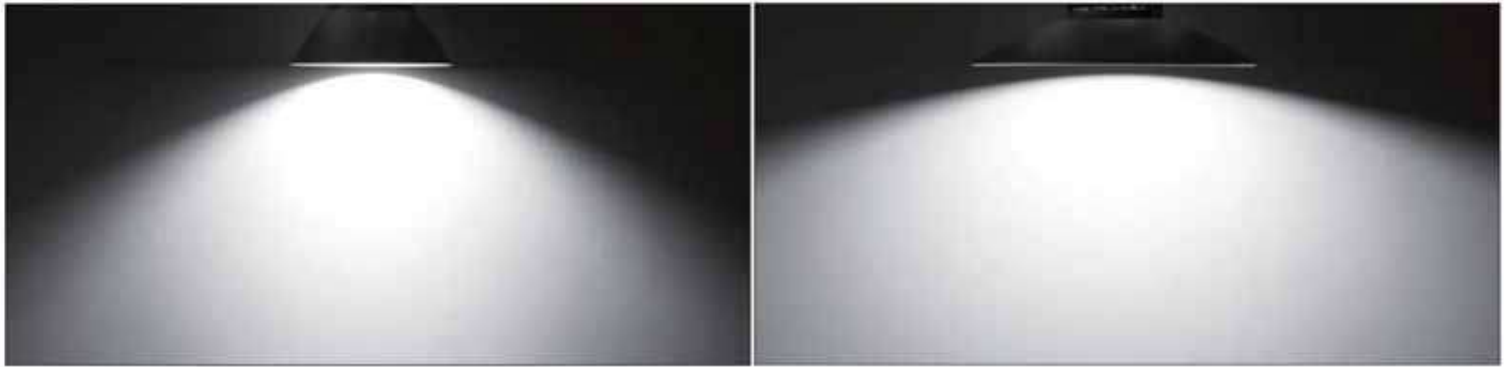

LED

OPL-HB-E48/30-60

OPL-HB-E48/57-60

48W-60°

3000K, 5700K

4320 Lumen



LED

OPL-HB-E48/30-120

OPL-HB-E48/57-120

48W-120°

3000K, 5700K

4320 Lumen

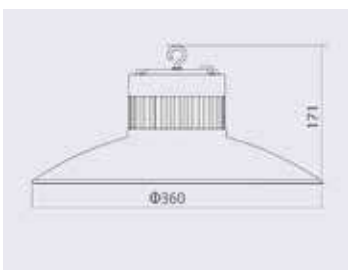

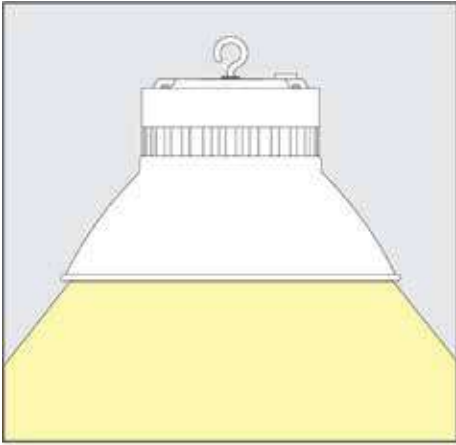

LED

OPL-HB-E100/57-60

100W-60

5700K

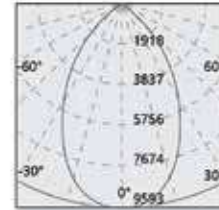
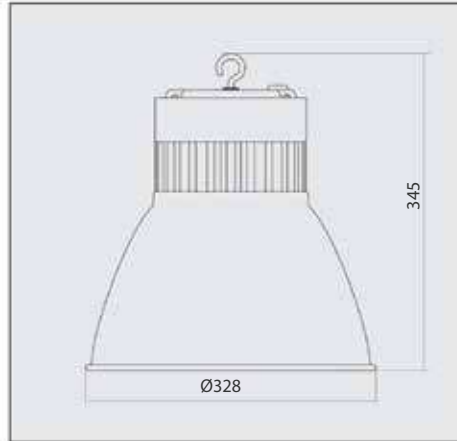

OPL-HB-E100/57-60

100W-5700K-60°

9000LM

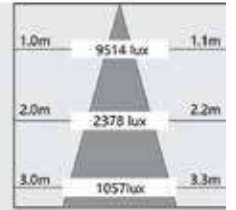

OPL-HB-E150/57-60

150W-60°

5700K

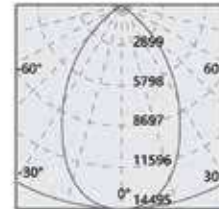
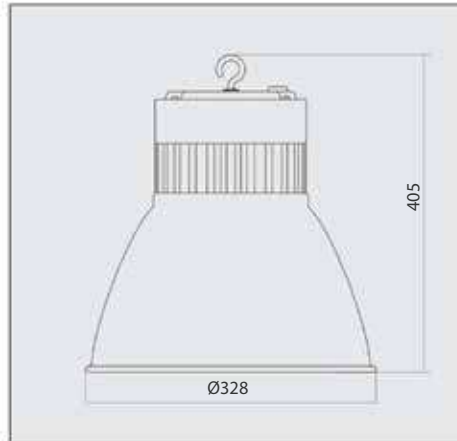

OPL-HB-E150/57-60

150W-5700K-60°

13500LM

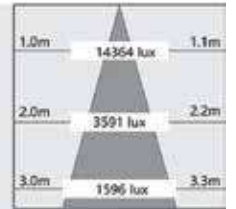

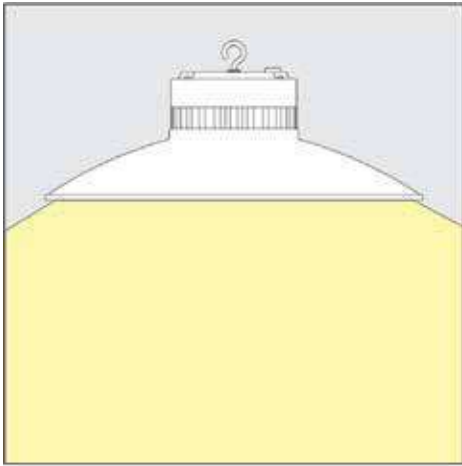

LED
OPL-HB-E100/57-90
100W-90
5700K

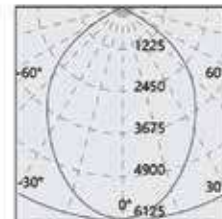

OPL-HB-E100/57-90
100W-5700K-90°
10500LM



OPL-HB-E150/57-90
150W-90
5700K

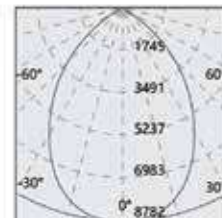
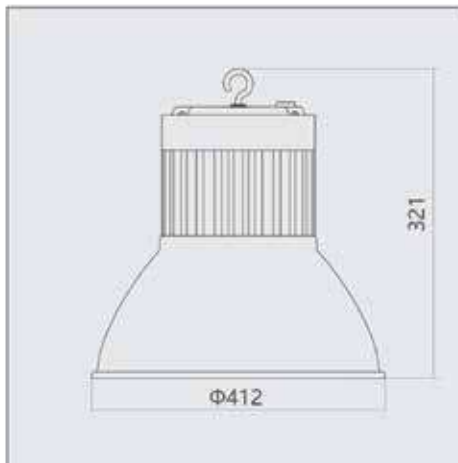

OPL-HB-E150/57-90
150W-5700K-90°
15750LM



LED NIGHTLIGHT

OPL-NIGHT

OPL-NIGHT/MO

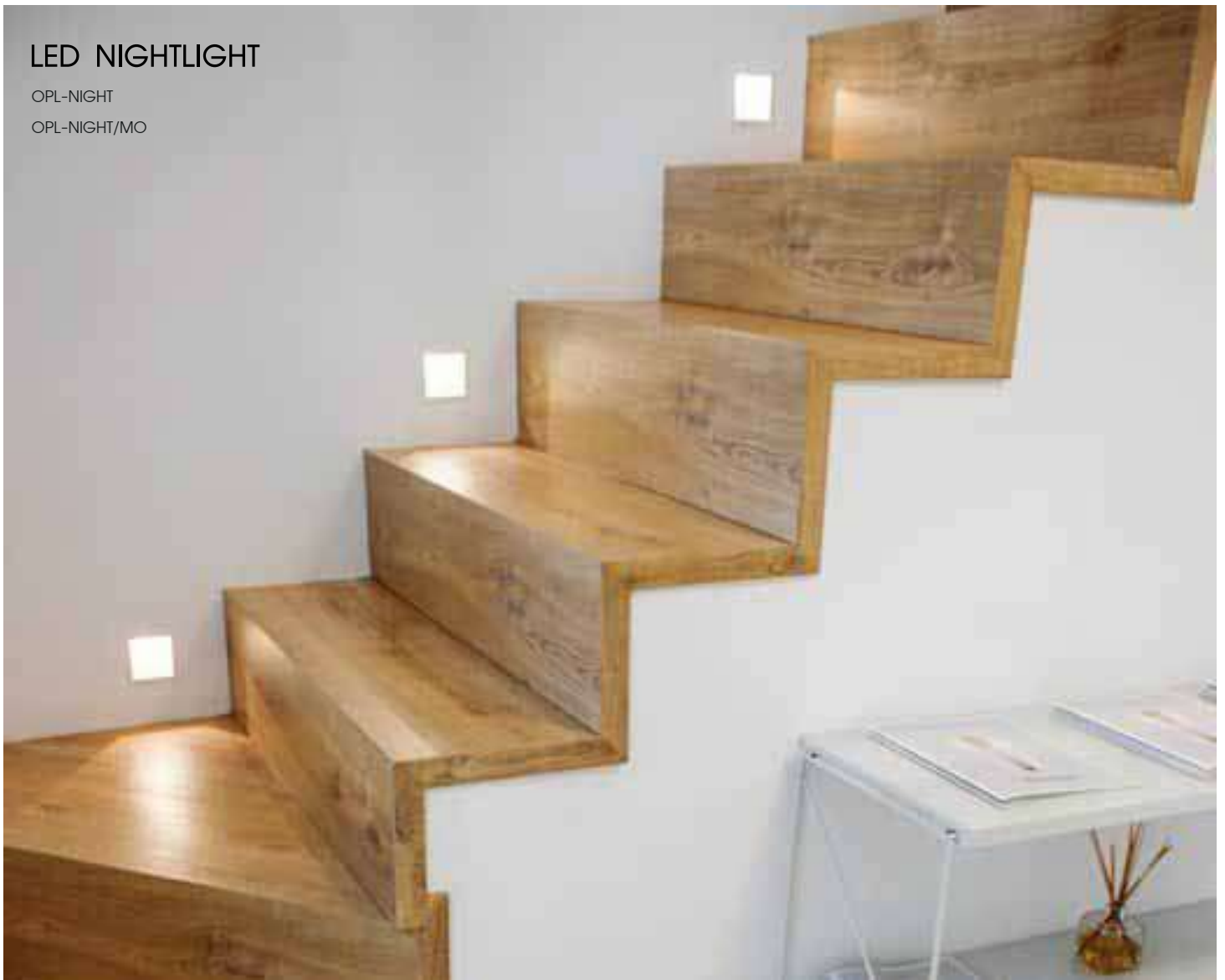

Motion Sensor
ทำงานตอนกลางคืนเมื่อมีการเดินผ่าน



LED
OPL-NIGHT/MO
1W
3000K



LED
OPL-NIGHT
1W
3000K

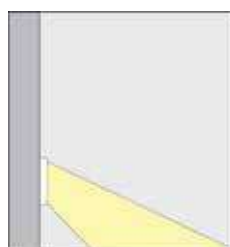
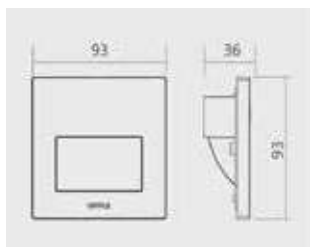
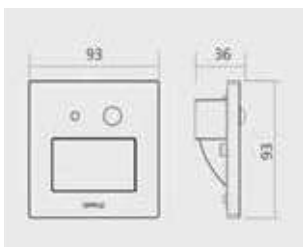

ใช้ BOX ฝังแบบ MK BOX



LED READING LAMP

Material: Aluminum

LED: 3W LED 3000K, U.S Cree chip+CE Driver

Switch: Yes , (metal switch)

Function: Auminum head can be move up,down, right & left

Features: plastic slip inside to protect scratch Insert installation



WI-BOOKIE/WH

Aluminum
LED 3W 3000K
2,200.-



WI-BOOKIE/BK

Aluminum
LED 3W 3000K
2,200.-

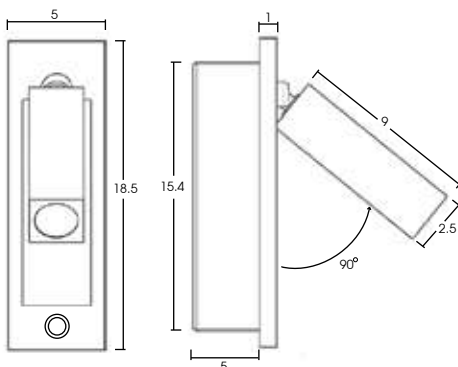

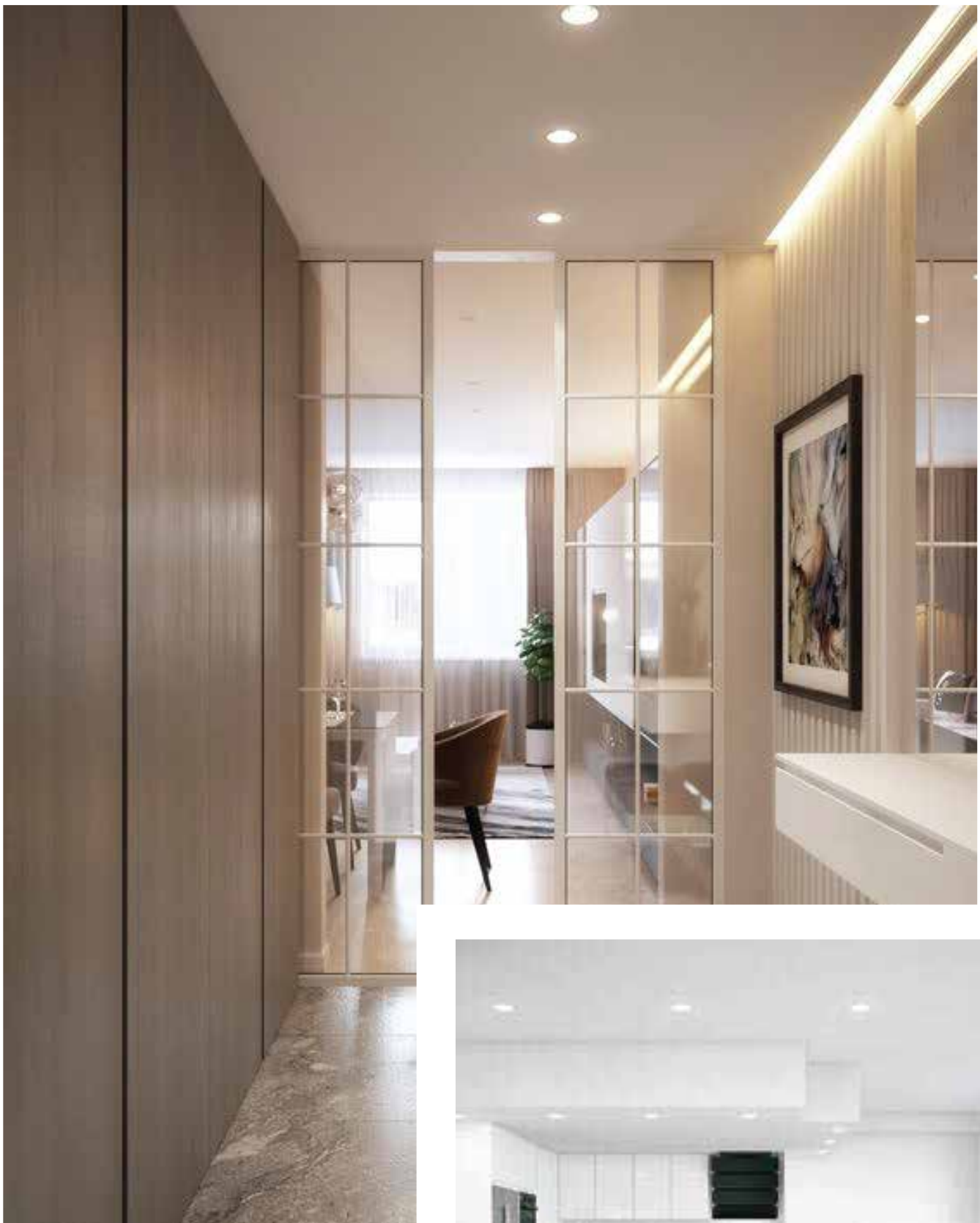

DESIGN LIGHTING
DOWNLIGHT

LED PANEL SLIM ROUND

Recess Downlight

ALUMINIUM BODY, WORKING VOLTAGE AC 85-265V, CHIP TYPE EPISTAR

LUMEN PER WATT 85-90 LM/WATT, BEAM ANGLE 120 DEG

LIFE TIME 25,000 Hrs,



พ.นท. 1955-2551



ใช้ตัวต่อแบบพิเศษไม่ต้องใช้อุปกรณ์ในการเปลี่ยน Driver ในกรณีฉุกเฉิน

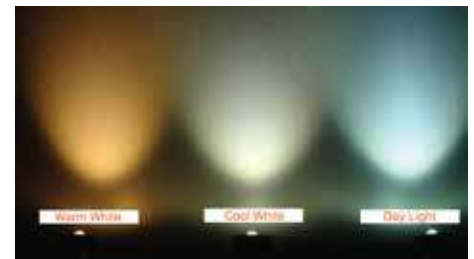

3000K

4000K

6000K

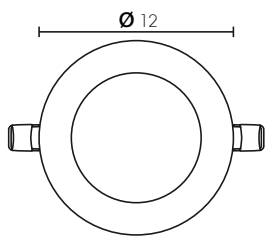

DL-PN006E/30/LTO
DL-PN006E/60/LTO
EPISTAR 2835 SMD LED CHIP
540 LM
220V, AC, 50/60HZ
110.-

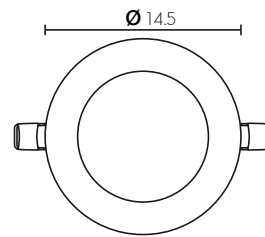

DL-PN009E/30/LTO
DL-PN009E/40/LTO
DL-PN009E/60/LTO
EPISTAR 2835 SMD LED CHIP
810 LM
220V, AC, 50/60HZ
150.-

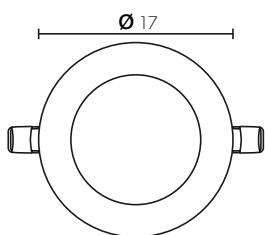

DL-PN012E/30/LTO
DL-PN012E/40/LTO
DL-PN012E/60/LTO
EPISTAR 2835 SMD LED CHIP
1080 LM
220V, AC, 50/60HZ
200.-

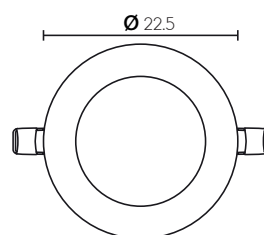

DL-PN018E/30/LTO
DL-PN018E/40/LTO
DL-PN018E/60/LTO
EPISTAR 2835 SMD LED CHIP
1620 LM
220V, AC, 50/60HZ
300.-



LED PANEL SLIM SQUARE

Recess Downlight

ALUMINIUM BODY, WORKING VOLTAGE AC 85-265V, CHIP TYPE EPISTAR

LUMEN PER WATT 85-90 LM/WATT, BEAM ANGLE 120 DEG

LIFE TIME 25,000 Hrs.



มอก. 1955-2551



ใช้ตัวต่อแบบพิเศษไม่ต้องใช้อุปกรณ์ในการเปลี่ยน Driver ในารซ่อมแซม

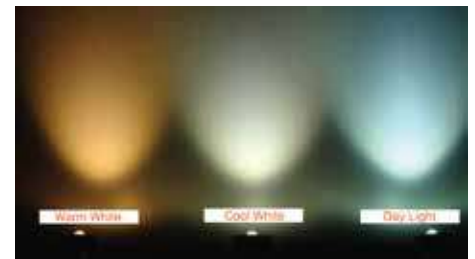

3000K

4000K

6000K

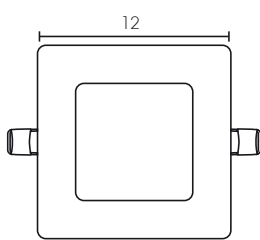

DL-PN406E/30/LTO
DL-PN406E/60/LTO
EPISTAR 2835 SMD LED CHIP
540 LM
220V.AC, 50/60HZ
110.-

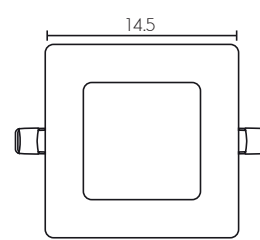

DL-PN409E/30/LTO
DL-PN409E/60/LTO
EPISTAR 2835 SMD LED CHIP
810 LM
220V.AC, 50/60HZ
150.-

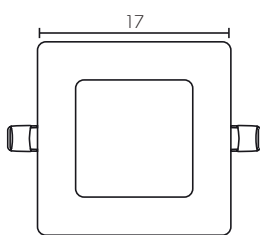

DL-PN412E/30/LTO
DL-PN412E/40/LTO
DL-PN412E/60/LTO
EPISTAR 2835 SMD LED CHIP
1080 LM
220V.AC, 50/60HZ
200.-

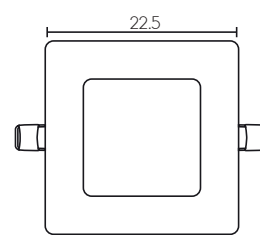

DL-PN418E/30/LTO
DL-PN418E/60/LTO
EPISTAR 2835 SMD LED CHIP
1620 LM
220V.AC, 50/60HZ
300.-



LED PANEL SLIM ROUND

Surface Downlight

ALUMINIUM BODY, WORKING VOLTAGE AC 85-265V, CHIP TYPE EPISTAR

LUMEN PER WATT 85-90 LM/WATT, BEAM ANGLE 120 DEG

LIFE TIME 25,000 Hrs.



มอก. 1955-2551



ใช้ตัวต่อแบบพิเศษไม่ต้องใช้ปรอทในการเปลี่ยน Driver ในการซ่อมแซม

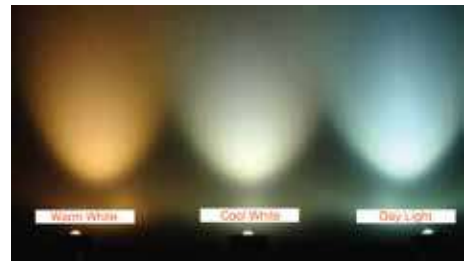

3000K

4000K

6000K

DB-PNS06E/30/LTO
DB-PNS06E/60/LTO
EPISTAR 2835 SMD LED CHIP
540 LM
220V,AC, 50/60HZ
200,-

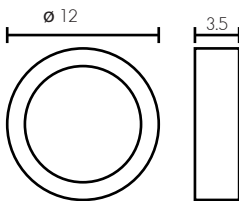

DB-PNS012E/30/LTO
DB-PNS012E/60/LTO
EPISTAR 2835 SMD LED CHIP
1080 LM
220V,AC, 50/60HZ
300,-

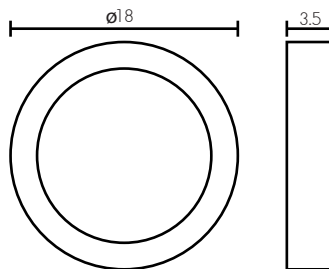

DB-PNS018E/30/LTO
DB-PNS018E/40/LTO
DB-PNS018E/60/LTO
EPISTAR 2835 SMD LED CHIP
1620 LM
220V,AC, 50/60HZ
400,-

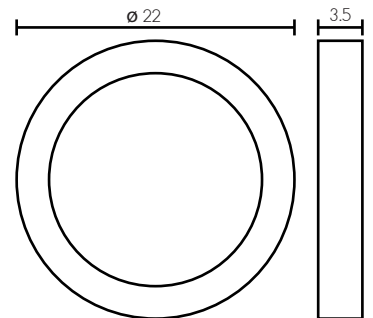

LED PANEL SLIM SQUARE

Surface Downlight

ALUMINIUM BODY, WORKING VOLTAGE AC 85-265V, CHIP TYPE EPISTAR

LUMEN PER WATT 85-90 LM/WATT, BEAM ANGLE 120 DEG

LIFE TIME 25,000 Hrs.



มอก. 1955-2551



ใช้ตัวต่อแบบพิเศษไม่ต้องใช้อุปกรณ์ในการเปลี่ยน Driver ในารซ่อมแซม

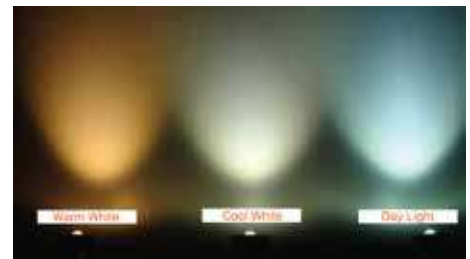

3000K

4000K

6000K

DB-PNS406E/30/LTO
DB-PNS406E/40/LTO
DB-PNS406E/60/LTO
EPISTAR 2835 SMD LED CHIP
540 LM
220V,AC, 50/60HZ
220,-

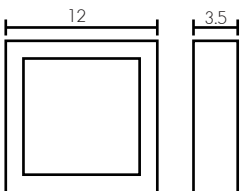

DB-PNS412E/30/LTO
DB-PNS412E/60/LTO
EPISTAR 2835 SMD LED CHIP
1080 LM
220V,AC, 50/60HZ
300,-

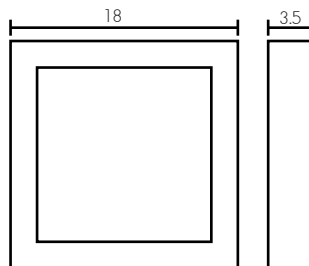

DB-PNS418E/30/LTO
DB-PNS418E/40/LTO
DB-PNS418E/60/LTO
EPISTAR 2835 SMD LED CHIP
1620 LM
220V,AC, 50/60HZ
440,-

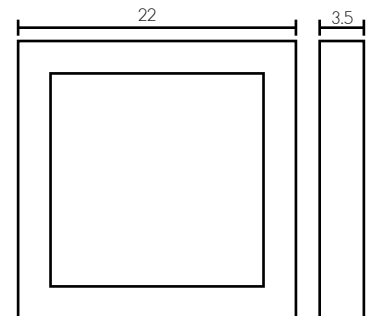



LED PANEL SLIM DIMMABLE

Recess Downlight

ALUMINIUM BODY, WORKING VOLTAGE AC 85-265V, CHIP TYPE EPISTAR

LUMEN PER WATT 85-90 LM/WATT, BEAM ANGLE 120 DEG

LIFE TIME 25,000 Hrs,

****ปรับไฟหรือไฟได้**



มอก.1955-2551

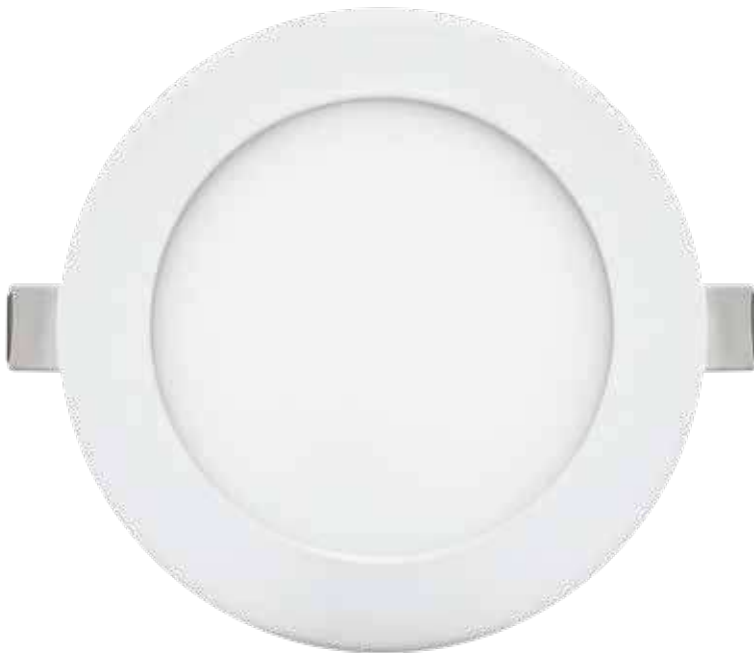

DL-PN009W/DIM/LTO

EPISTAR 2835 SMD LED CHIP

720 LM DIMMABLE

220V.AC, 50/60HZ

400.-

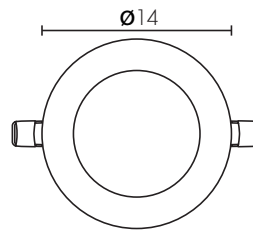

DL-PN409W/DIM/LTO

EPISTAR 2835 SMD LED CHIP

720 LM DIMMABLE

220V.AC, 50/60HZ

400.-

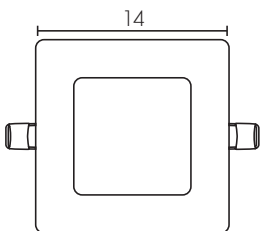

LED PANEL SLIM ROUND

Recess Downlight

ALUMINIUM BODY, WORKING VOLTAGE AC 85-265V, CHIP TYPE EPISTAR

LUMEN PER WATT 75 LM/WATT, BEAM ANGLE 120 DEG

LIFE TIME 25,000 Hrs.



พ.น. 1955-2551

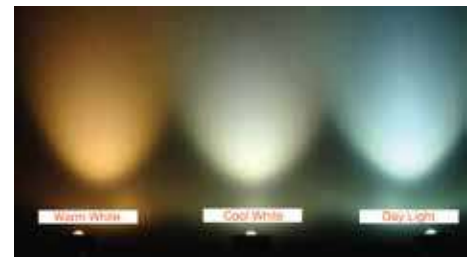

3000K

4000K

6000K

DL-PN809/30/LTO

EPISTAR 2835 SMD LED CHIP

540 LM

85-265V, AC, 50/60HZ

400.-

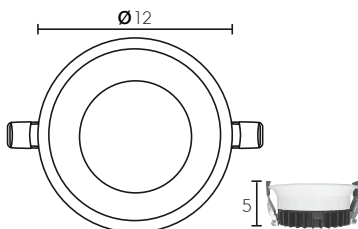

DL-PN812/30/LTO

EPISTAR 2835 SMD LED CHIP

810 LM

85-265V, AC, 50/60HZ

400.-

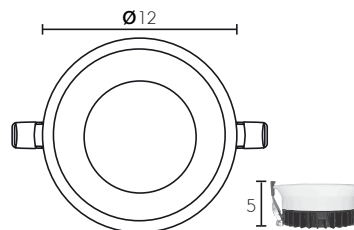

LED PANEL SLIM ROUND

Recess Downlight

ALUMINIUM BODY, WORKING VOLTAGE AC 85-265V, CHIP TYPE EPISTAR

LUMEN PER WATT 90-100 LM/WATT, BEAM ANGLE 120 DEG

LIFE TIME 25,000 Hrs,

รุ่นขอบเล็ก
เพียง 5 มม.



มอก. 1955-2551

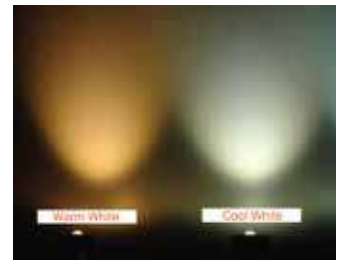

3000K

4000K

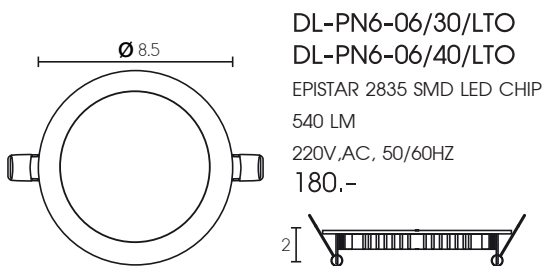

DL-PN6-06/30/LTO
DL-PN6-06/40/LTO
EPISTAR 2835 SMD LED CHIP
540 LM
220V.AC, 50/60HZ
180.-

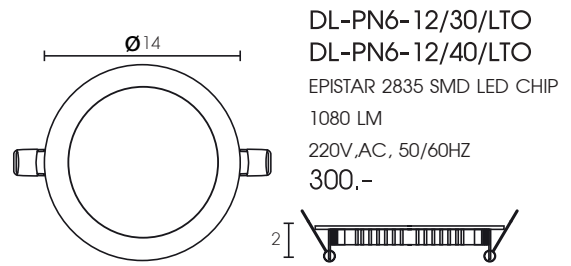

DL-PN6-12/30/LTO
DL-PN6-12/40/LTO
EPISTAR 2835 SMD LED CHIP
1080 LM
220V.AC, 50/60HZ
300.-

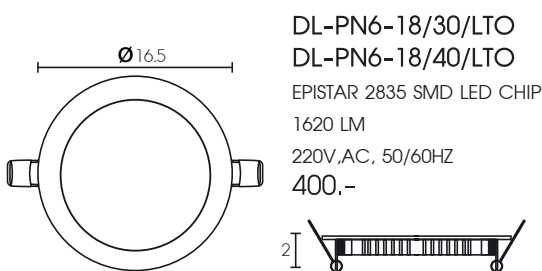

DL-PN6-18/30/LTO
DL-PN6-18/40/LTO
EPISTAR 2835 SMD LED CHIP
1620 LM
220V.AC, 50/60HZ
400.-

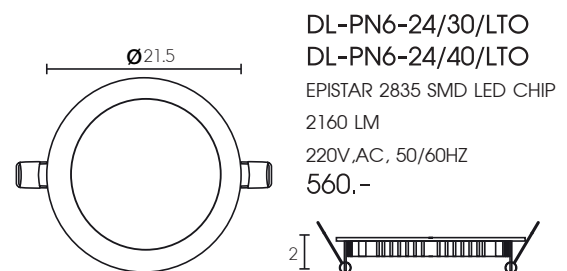

DL-PN6-24/30/LTO
DL-PN6-24/40/LTO
EPISTAR 2835 SMD LED CHIP
2160 LM
220V.AC, 50/60HZ
560.-

LED PANEL SLIM ROUND

Recess Downlight

ALUMINIUM BODY, WORKING VOLTAGE AC 85-265V, CHIP TYPE EPISTAR

LUMEN PER WATT 90-100 LM/WATT, BEAM ANGLE 120 DEG

LIFE TIME 25,000 Hrs,

รุ่นขอบเล็ก
เพียง 5 มม.



พ.ณ. 1955-2551

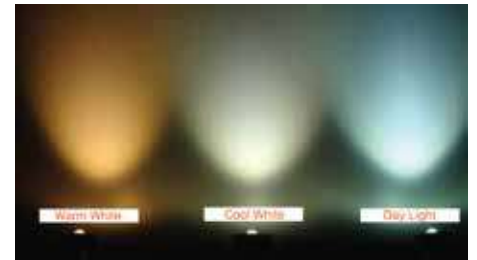

3000K

4000K

6000K

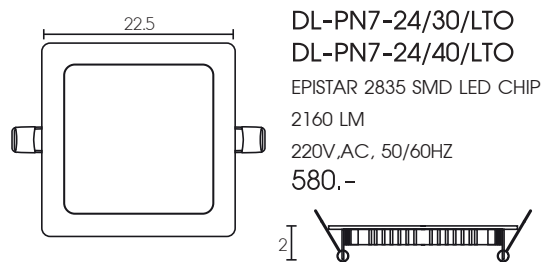
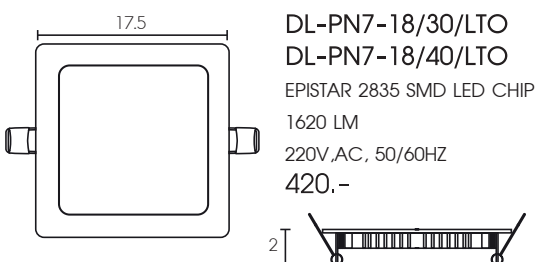
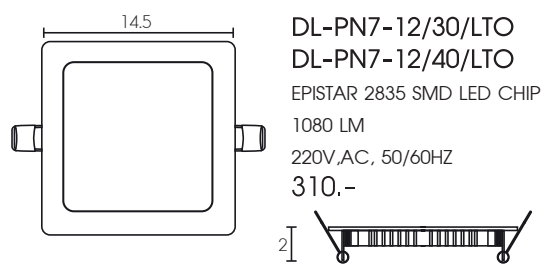
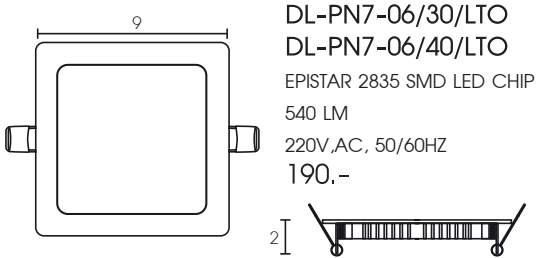

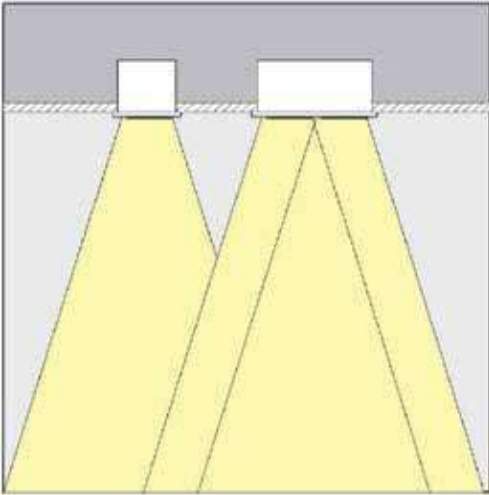

DOWNLIGHT

Recess Downlight

ALUMINIUM BODY, WORKING VOLTAGE AC 85-265V, CHIP TYPE EPISTAR



OPL-MATRIX-S1/30
OPL-MATRIX-S1/40
LED 10W 800lm (3000K 4000K)
W11.5 x L11.5 x H8.3



9.5x9.5



OPL-MATRIX-S2/30
OPL-MATRIX-S2/40
LED 10Wx2 1600lm (3000K 4000K)
W11.5 x L20.5 x H8.3



9.5x17.5



OPL-MATRIX-M1/30
OPL-MATRIX-M1/40
LED 20W 1800lm (3000K 4000K)
W14.7 x L14.7 x H11.7



13x13



OPL-MATRIX-M2/30
OPL-MATRIX-M2/40
LED 10Wx2 3600lm (3000K 4000K)
W14.7 x L26.4 x H11.7



13x25.5

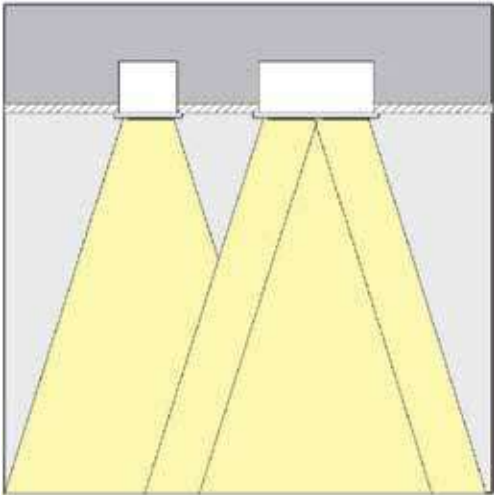

DOWNLIGHT

Recess Downlight

ALUMINIUM BODY, WORKING VOLTAGE AC 85-265V, CHIP TYPE EPISTAR



OPL-MATRIX-L1/30
OPL-MATRIX-L1/40
LED 30W 2700lm (3000K 4000K)
W14.7 x L14.7 x H11.7



13x13



OPL-MATRIX-L2/30
OPL-MATRIX-L2/40
LED 30Wx2 5400lm (3000K 4000K)
W14.7 x L26.4 x H11.7



13x25.5



OPL-MATRIX-XL1/30
OPL-MATRIX-XL1/40
LED 40W 3850lm (3000K 4000K)
W18.5 x L18.5 x H14.5



16.5x16.5



OPL-MATRIX-XL2/30
OPL-MATRIX-XL2/40
LED 40Wx2 7700lm (3000K 4000K)
W18.5 x L34 x H14.5



16.5x32



(Project Ref.) USE OPL-MATRIX-M1/40
OPL-MATRIX-M2/40

DOWNLIGHT

OPL-ROUND-SA
OPL-ROUND-SB
OPL-ROUND-SC



LED DOWNLIGHT

- ใช้เลนส์ UGRK 13 ป้องกันแสงสะท้อนและป้องกันดวงตา
- อายุการใช้งานยาวนาน
- แสงใกล้เคียงฮาโลเจนปกติ

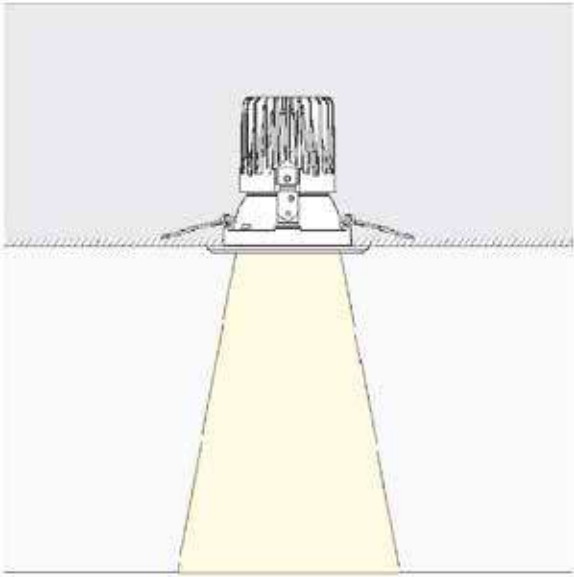

DOWNLIGHT

Recess Downlight

ALUMINIUM BODY, WORKING VOLTAGE AC 85-265V, CHIP TYPE EPISTAR



SA

OPL-ROUND-SA/30
LED 10W 500lm (3000K)
Ø10 x H9.6



8.5



SB

OPL-ROUND-SB/30
LED 10W 500lm (3000K)
Ø10 x H9.6



8.5



SC

OPL-ROUND-SC/30
LED 10W 160lm (3000K)
Ø10 x H9.6



8.5

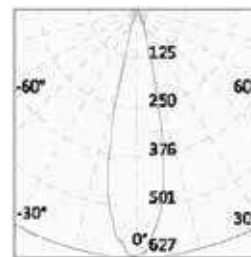
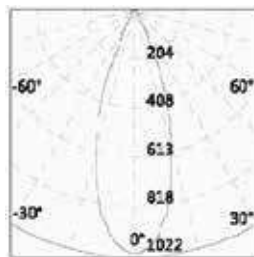

DOWNLIGHT

OPL-ROUND-MA
OPL-ROUND-LA



LED DOWNLIGHT

- หมุนได้ 355 องศา
- ปรับองศาได้ 35 องศา
- แสงสบายตามีลำแสงแคบและกว้างให้เลือก
- ฟลักซ์ส่องสว่างช่อง UGR<16



COB LED

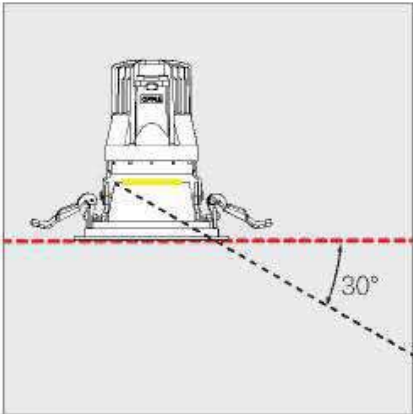

UGR<16



หมุนได้ 355° ปรับได้ 30°

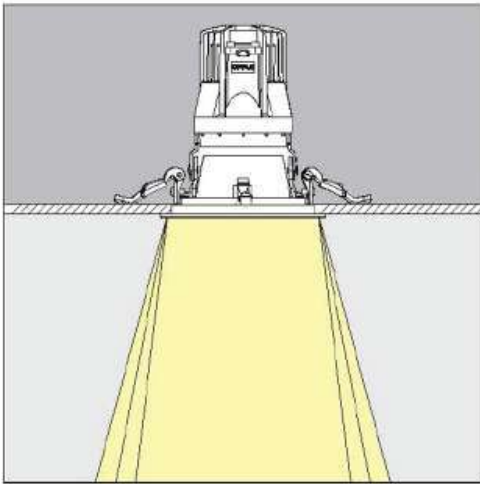

OPL-ROUND-MA/30-24
OPL-ROUND-MA/30-40
LED 16W (3000K)
Ø12 x H13.8



11.2



OPL-ROUND-LA/30-24
OPL-ROUND-LA/30-40
LED 30W (3000K)
Ø17.7 x H19.5



16.2

OPL-ROUND-MA-16-WM-24°-3000K

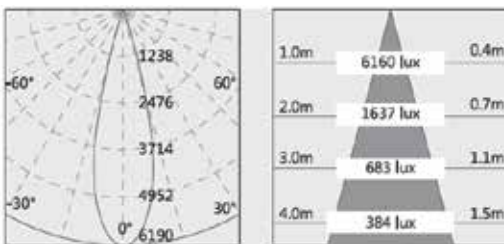

OPL-ROUND-MA-16-WM-40°-3000K

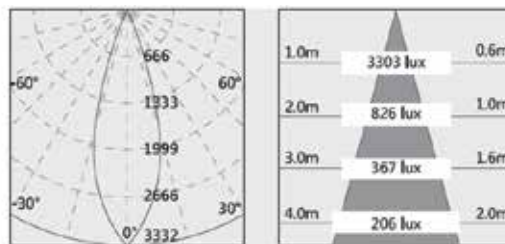

OPL-ROUND-LA-30W-WM-24°-3000K

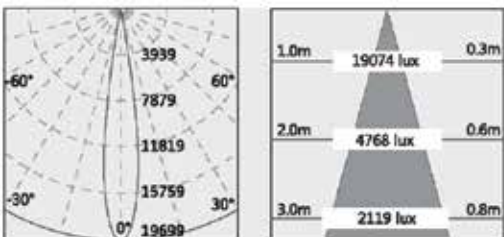

OPL-ROUND-LA-30W-WM-40°-3000K

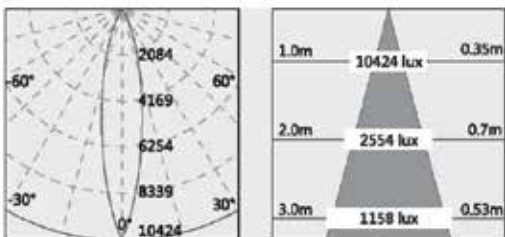

DOWNLIGHT

OPL-DHM14
OPL-DHM29
OPL-DHM42



14W

29/42W

LED DOWNLIGHT

LIFE : 30000Hrs.

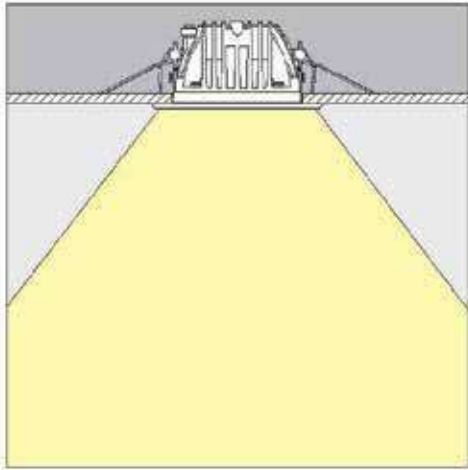

DOWNLIGHT

Recess Downlight

ALUMINIUM BODY, WORKING VOLTAGE AC 85-265V, CHIP TYPE EPISTAR



OPL-DHM14/30
OPL-DHM14/40
OPL-DHM14/57

LED 14W 1200lm (3000K 4000K 5700K)
Ø18.5 x H9.4



17.5

OPL-DHM29/30
OPL-DHM42/30
OPL-DHM29/40
OPL-DHM42/40
OPL-DHM29/57
OPL-DHM42/57

LED 29W, 42W (3000K 4000K 5700K)
Ø22 x H11.6



21

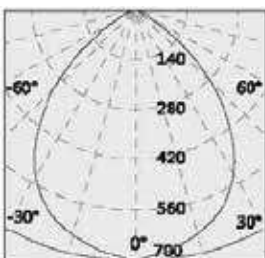

OPL-DHM14/40°-14W-4000K-1200LM

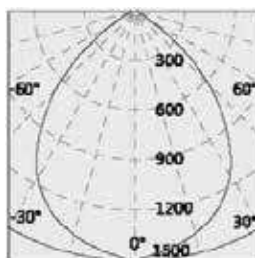

OPL-DHM29/40°-29W-4000K-2500LM



DL-N116-1
W15.5 x L15.5 x H17.5
E27 A60 x 1
640.-



14.3x14.3



DL-N116-2
W15.5 x L29 x H17.5
E27 A60 x 2
1,240.-



14.3x17.5

DOWNLIGHT

Recess Downlight

COLD-ROLL STEEL SHEET, COATED WITH POLYESTER POWDER

ALUMINIUM ANODIZED REFLECTOR

RECESSED T-BAR OR GYPSUM MOUNTING



DL-11611
W14 x L14 x H18
E27 A60 x 1
700,-



12x12



DL-11612
W14 x L25 x H18
E27 A60 x 2
1,400,-



12x23

DOWNLIGHT

Recess Downlight

COLD-ROLL STEEL SHEET, COATED WITH POLYESTER POWDER

ALUMINIUM ANODIZED REFLECTOR

RECESSED T-BAR OR GYPSUM MOUNTING



DL-11711
W20 x L20 x H17
E27 A70 x 1
800.-



16.5x16.5



DL-11712
W20 x L36.5 x H17
E27 A70 x 2
1,500.-



16x34

DOWNLIGHT

Recess Downlight

COLD-ROLL STEEL SHEET, COATED WITH POLYESTER POWDER

ALUMINIUM ANODIZED REFLECTOR

RECESSED T-BAR OR GYPSUM MOUNTING



DOWNLIGHT

Recess Downlight

COLD-ROLL STEEL SHEET, COATED WITH POLYESTER POWDER

ALUMINIUM ANODIZED REFLECTOR



DL-10311
W13 x L13 x H16
E27 x 1
200.-



11x11



DL-10312
W13 x L24 x H16
E27 x 2
400.-



11x22



DL-10313
W13 x L35.5 x H16
E27 x 3
680.-



11x33,5



DOWNLIGHT

Recess Downlight

COLD-ROLL STEEL SHEET, COATED WITH POLYESTER POWDER

ALUMINIUM ANODIZED REFLECTOR

RECESSED T-BAR OR GYPSUM MOUNTING



DL-10661
W13 x L13 x H13.5
E27 x 1
360,-



11.5x11.5



DL-10662
W13 x L24.5 x H13.5
E27 x 2
560,-



11.5x23

DOWNLIGHT

Recess Downlight

COLD-ROLL STEEL SHEET, COATED WITH POLYESTER POWDER

ALUMINIUM ANODIZED REFLECTOR

RECESSED MOUNTING



DL-10411
W13 x L13 x H16
E27 x 1
200.-



11x11



DL-10412
W13 x L24.5 x H16
E27 x 2
420.-



11x22.5



DL-10413
W13 x L35.5 x H16
E27 x 3
800.-



11x33

DOWNLIGHT

Recess Downlight

COLD-ROLL STEEL SHEET, COATED WITH POLYESTER POWDER

ALUMINIUM ANODIZED REFLECTOR



DL-P400-1
W18.5 x L18.5 x H14.5
E27 PAR 30 x1
800.-



17x17



DL-P400-2
W18.5 x L33.5 x H14.5
E27 PAR 30 x 2
1,600.-



17x32



หมุนได้ 360°

▶ ขาปรับองศา
หน้าโคม

DOWNLIGHT

Recess Downlight

COLD-ROLL STEEL SHEET, COATED WITH POLYESTER POWDER

ALUMINIUM ANODIZED REFLECTOR

RECESSED T-BAR OR GYPSUM MOUNTING



DL-441
W12.8 x L12.8 x H14.5
E27 x 1
180.-



11x11

DL-441-H16
W12.8 x L12.8 x H16
E27 x 1
200.-



DL-412
W13 x L13 x H16.5
E27 x 1
200.-



11x11



DL-10416
W12.5 x L12.5 x H14.2
E27 x 1
200.-
หน้าขอบอลูมิเนียม



11x11

DL-11417
W14.5 x L14.5 x H17.5
E27 x 1
450.-



12x12





DOWNLIGHT

Recess Downlight

COLD-ROLL STEEL SHEET, COATED WITH POLYESTER POWDER

ALUMINIUM ANODIZED REFLECTOR

RECESSED T-BAR OR GYPSUM MOUNTING



DL-L1441/S
W13.5 x L13.5 x H13.5
E27 x 1
120.-



11.5x11.5



DL-11416/G
W12.5 x L12.5 x H18
E27 x 1
480.-



11.5x11.5



DL-11811
W12.5 x L12.5 x H18
E27 x 1
720.-



10x10

DOWNLIGHT

Recess Downlight

COLD-ROLL STEEL SHEET, COATED WITH POLYESTER POWDER

ALUMINIUM ANODIZED REFLECTOR

GLASS COVER TO PROVIDE SMOOTH AND DIFFUSE AMBIENT LIGHT

RECESSED MOUNTING



DLN-11416N
W13 x L13 x H7.5
E27 x 1
300.-



11x11



DLN-11418N
W17.5 x L17.5 x H9
E27 x 1
500.-



15.5x15.5



DLN-11418N/2E27
W17.5 x L17.5 x H8.5
E27 x 2
500.-



15.5x15.5





DOWNLIGHT

Recess Downlight

COLD-ROLL STEEL SHEET, COATED WITH POLYESTER POWDER

ALUMINIUM ANODIZED REFLECTOR

GLASS COVER TO PROVIDE SMOOTH AND DIFFUSE AMBIENT LIGHT

RECESSED T-BAR OR GYPSUM MOUNTING



DLN-J165
W16.5 x L16.5 x H13
E27 x 2
550.-



15.5x15.5



DLN-J165/G
W16.5 x L16.5 x H13
E27 x 2
750.-



15.5x15.5

DOWNLIGHT

Recess Downlight

COLD-ROLL STEEL SHEET, COATED WITH POLYESTER POWDER

ALUMINIUM ANODIZED REFLECTOR

GLASS COVER TO PROVIDE SMOOTH AND DIFFUSE AMBIENT LIGHT

RECESSED T-BAR OR GYPSUM MOUNTING

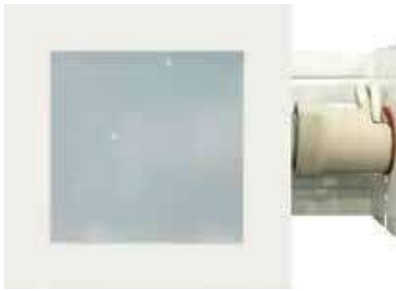

DLN-12610/SYL
W10.5 x L10.5 x H7
E27 x 1
360.-



8.5x8.5



DLN-12612
W13 x L13 x H8.5
E27 x 1
360.-



11.5x11.5



DLN-12614
W16.3 x L16.3 x H8.5
E27 x 2
550.-



14.3x14.3



DLN-12616
W18 x L18 x H9
E27 x 2
750.-



16.5x16.5



DOWNLIGHT

Recess Downlight

COLD-ROLL STEEL SHEET, COATED WITH POLYESTER POWDER

ALUMINIUM ANODIZED REFLECTOR

GLASS COVER TO PROVIDE SMOOTH AND DIFFUSE AMBIENT LIGHT

RECESSED T-BAR OR GYPSUM MOUNTING



DLN-12611
W12.5 x L12.5 x H8.5
E27 x 1
360.-



11x11



DLN-12613
W16.3 x L16.3 x H8.5
E27 x 2
550.-



14.3x14.3



DLN-12615
W18 x L18 x H9
E27 x 2
750.-



16.5x16.5

DOWNLIGHT

Recess Downlight

COLD-ROLL STEEL SHEET, COATED WITH POLYESTER POWDER

ALUMINIUM ANODIZED REFLECTOR

RECESSED T-BAR OR MOUNTING



DL-10222/WH
Ø13.7 x H16.5
E27 x 1
280.-



11.5



DL-10222/BK
Ø13.7 x H16.5
E27 x 1
300.-



11.5

DOWNLIGHT

Recess Downlight

COLD-ROLL STEEL SHEET, COATED WITH POLYESTER POWDER

ALUMINIUM ANODIZED REFLECTOR

GLASS COVER TO PROVIDE SMOOTH AND DIFFUSE AMBIENT LIGHT



Reflex รุ่นพีพีพี
ช่วยกระจายความร้อน



DL-L141/S
Ø14.5 x H13.5
E27 x 1
70.-



12.5



DL-L141/SN
Ø14.5 x H13.5
E27 x 1
70.-



12.5



DL-L171/S
Ø18 x H15.5
E27 A70 x 1
110.-



15.5



DL-L171/SN
Ø18 x H15.5
E27 A70 x 1
110.-



15.5

DOWNLIGHT

Recess Downlight

COLD-ROLL STEEL SHEET, COATED WITH POLYESTER POWDER

ALUMINIUM ANODIZED REFLECTOR

GLASS COVER TO PROVIDE SMOOTH AND DIFFUSE AMBIENT LIGHT



DL-121/3/A
Ø12 x H13.5
E27x1
60.-



DL-171/3/A
Ø18 x H18
E27x1
100.-



DL-171/3/A-1
Ø18 x H18
E27x1
100.-



DL-171/3/SN
Ø18 x H18
E27x1
120.-



DL-171/3/SA
Ø18 x H18
E27x1
120.-



DOWNLIGHT

Recess Downlight

COLD-ROLL STEEL SHEET, COATED WITH POLYESTER POWDER

ALUMINIUM ANODIZED REFLECTOR

GLASS COVER TO PROVIDE SMOOTH AND DIFFUSE AMBIENT LIGHT



DL-P30
Ø14 x H14.5
E27 PAR30 x1
200.-



12



DL-L141/G-1
Ø14.5 x H13.5
E27 x 1
200.-



12.5



DL-L171/G-1
Ø18 x H15.5
E27 A70 x 1
240.-



16

DOWNLIGHT

Recess Downlight

COLD-ROLL STEEL SHEET, COATED WITH POLYESTER POWDER

ALUMINIUM ANODIZED REFLECTOR



DLN-141/S
Ø14.2 x H8.7
E27 x 1
160.-



12.2



รุ่นพิเศษสูงเพียง 7 cm.

DLN-2600
Ø17.8 x H7
E27x1
320.-



15.8



DLN-171/S
Ø17.8 x H9.5
E27 x 1
220.-



15.8



DLN-171/SN
Ø17.8 x H9.5
E27 x 2
220.-



15.8



DLN-191/A
Ø19 x H8.5
E27 x 1
300.-



17



DLN-191/S
Ø19 x H8.5
E27 x 1
300.-



17



DLN-191/SN
Ø19 x H8.5
E27 x 1
300.-



17

DOWNLIGHT

Recess Downlight

COLD-ROLL STEEL SHEET, COATED WITH POLYESTER POWDER

ALUMINIUM ANODIZED REFLECTOR



DLN-141/G
Ø14.5 x H9
E27 x 1
240.-



12.5



DLN-141/G-1
Ø14.5 x H9
E27 x 1
240.-



12.5



DLN-171/G-1
Ø17.8 x H9.5
E27 x 1
300.-



15.8



DLN-171/G/SYL
Ø17.8 x H11
E27x2
240.-



15.8

DOWNLIGHT

Recess Downlight

COLD-ROLL STEEL SHEET, COATED WITH POLYESTER POWDER

ALUMINIUM ANODIZED REFLECTOR



DLN-2805-A
Ø21.7 x H12.5
E27 x 2/G24x2
600.-



DLN-2701-B
Ø21 x H15
E27x2/G24x2
700.-



DLN-221/S
Ø21.7 x H12.5
E27x2/G24x2
580.-



DLN-221/SN
Ø21.7 x H12.5
E27x2/G24x2
580.-



DLN-221/G
Ø23 x H9
E27x2/G24x2
700.-



DLN-231/G-1
Ø23 x H13
E27x2/G24x2
700.-





DOWNLIGHT

Recess Downlight

COLD-ROLL STEEL SHEET, COATED WITH POLYESTER POWDER

ALUMINIUM ANODIZED REFLECTOR

RECESSED T-BAR OR MOUNTING



DH-3022
Ø17 x H9.3
QR111x1
720.-



16.5

DOWNLIGHT

Multiple Recess Downlight

ALUMINIUM, COATED WITH POLYESTER POWDER

RECESSED T-BAR OR GYPSUM MOUNTING



DL-23301/G12
W19 x L19 x H16.5
G12x1
950.-



16.5x16.5



DL-23302/G12
W19 x L35 x H16
G12x2
1,800.-



16.5x33



DL-23111/P30
W20 x L20 x H16
E27x1/PAR30
950.-



17x17



DL-23112/P30
W20 x L35 x H16
E27x2/PAR30
1,800.-



17x32



DL-22111
W19 x L19 x H12.7
QR111x1
500.-



16.5x16.5



DL-22112
W19 x L35.5 x H14
QR111x2
1,000.-



16.5x33.5

DOWNLIGHT

Multiple Recess Downlight

COLD-ROLL STEEL SHEET, COATED WITH POLYESTER POWDER

ALUMINIUM ANODIZED REFLECTOR

DOWNLIGHT

Multiple Recess Downlight

ALUMINIUM, COATED WITH POLYESTER POWDER

RECESSED T-BAR OR GYPSUM MOUNTING



DH-551
W19 x L19 x H13
QR111x1
500.-



16x16



DH-552/SYL
W21 x L35 x H11
QR111x2
800.-



19x33



DH-553/SYL
W21 x L50 x H11
QR111x3
1,200.-



19x48



DH-20111
W13 x L13 x H11.5
MR16x1
550.-



11x11



DH-20112
W13 x L23.5 x H11.5
MR16x2
1,100.-



11x21.5

DOWNLIGHT

Multiple Recess Downlight

COLD-ROLL STEEL SHEET, COATED WITH POLYESTER POWDER



DH-20121
W13 x L13 x H14.3
MR16x1
600.-



11x11



DH-20122
W13 x L23 x H14.3
MR16x2
1,200.-



11x21.5

DOWNLIGHT

Multiple Recess Downlight

COLD-ROLL STEEL SHEET, COATED WITH POLYESTER POWDER



สามารถดึงหน้าโคมและปรับองศาได้



DH-21816
W12.5 x L12.5 x H12
MR16x1
560.-



10.5x10.5



DH-22816
W12.5 x L23.5 x H12
MR16x2
900.-



11x21.5

DOWNLIGHT

Multiple Recess Downlight

COLD-ROLL STEEL SHEET, COATED WITH POLYESTER POWDER

DOWNLIGHT

Recess Downlight

COLD-ROLL STEEL SHEET, COATED WITH POLYESTER POWDER

RECESSED T-BAR OR GYPSUM MOUNTING



DH-20010
W9 x L9 x H9
MR16x1
250.-



7.5x7.5



DH-20010-G
W9 x L9 x H5.5
MR16x1
350.-



7.5x7.5



DH-20009
W9 x L12 x H7
MR16x1
300.-



7.5x10.5



DH-20010/3
W8.5 x L23 x H5.5
MR16x3
750.-



8x21

DOWNLIGHT

Multiple Recess Downlight

COLD-ROLL STEEL SHEET, COATED WITH POLYESTER POWDER



DH-531
W10 x L10 x H5.5
MR16x1
200.-



DH-532
W10 x L17.5 x H5.5
MR16x2
420.-



DH-533
W10.5 x L24.5 x H5.5
MR16x3
680.-



DH-534
W17.5 x L17.5 x H5.5
MR16x4
960.-





DH-GR17-1
W11 x L11 x H4.5
GU10 x 1
420.-



10x10



DH-GR17-2
W11 x L20.5 x H4.5
GU10 x 2
800.-



10x19.5

DOWNLIGHT

Recess Downlight

COLD-ROLL STEEL SHEET, COATED WITH POLYESTER POWDER

ALUMINIUM ANODIZED REFLECTOR



Hood ກັບແສງເບິ່ງຕາ



DH-851
W10 x L10 x H9.2
GU10x1
400.-



9x9



DH-852
W10 x L19 x H9.2
GU10x2
800.-



9x18

DOWNLIGHT

Recess Downlight

COLD-ROLL STEEL SHEET, COATED WITH POLYESTER POWDER
ALUMINIUM TRIM



DOWNLIGHT

Recess Downlight

ALUMINIUM, COATED WITH POLYESTER POWDER

RECESSED T-BAR OR GYPSUM MOUNTING



DH-521
W12.5 x L12.5 x H12
MR16x1
280.-



10.5x10.5



DH-522
W12.5 x L23 x H12
MR16x2
480.-



10.5x21



DOWNLIGHT

Recess Downlight

ALUMINIUM, COATED WITH POLYESTER POWDER

RECESSED T-BAR OR GYPSUM MOUNTING



DH-101
W10 x L10 x L5.6
MR16x1
180.-



8.5x8.5



DH-102N
Ø10 x H6
MR16x1
160.-



8.5



DH-2002
W9.2 x L9.2 x H5.5
MR16x1
300.-



7.5x7.5



DH-2002-R
Ø8.7 x H2.2
MR16x1
300.-



7.5

DOWNLIGHT

Multiple Recess Downlight

PURE-ALUMINIUM

RECESSED T-BAR OR GYPSUM MOUNTING



DH-20001
W9 x L9 x H2.5
MR16x1
250.-



8x8



DH-20002
W9 x L17.5 x H2.5
MR16x2
600.-



7.5x15.5



DH-20003
W9 x L25.5 x H2.5
MR16x3
900.-



8x24

DOWNLIGHT

Recess Downlight

COLD-ROLL STEEL SHEET, COATED WITH POLYESTER POWDER

RECESSED MOUNTING



DH-20783
Ø8.7 x H10
MR16x1
350.-



DH-20783/G
Ø8.7 x H10
MR16x1
450.-



DH-20784
Ø8.7 x H10
MR16x1
350.-



DOWNLIGHT

Recessed Downlight

ALUMINIUM COATED WITH POLYESTER POWDER

RECESS MOUNTING



DH-21515
Ø10.5 x H10
MR16x1
480.-



DH-21516
Ø10.5 x H10
MR16x1
480.-



DH-514W
Ø8 x H3
MR16x1
120.-



DH-504W
Ø9.5 x H3.7
MR16x1
140.-



DOWNLIGHT

Recessed Downlight

ALUMINIUM COATED WITH POLYESTER POWDER



DH-568
Ø10.3 x H2.7
MR16x1
300.-



DH-569
W10.3 x L10.3 x H2.5
MR16x1
340.-



DH-2022
Ø9.7 x H5
MR16x1
280.-



DH-12575
W9 x L9 x H4
MR16x1
300.-





DOWNLIGHT

Recess Downlight

DIE-CAST ALUMINIUM

RECESSED T-BAR OR GYPSUM MOUNTING



D-WW-Q603
Ø15.7 x H11.5
G8.5x1
800.-



14



D-MH-609
Ø16 x H18.5
G12x1
1,200.-



14



D-MH103
Ø19 x H17
G12
1,500.-



17



DB-L141/WH
Ø13 x H14
E27x1
300.-



DB-L141/BK
Ø13 x H14
E27x1
300.-

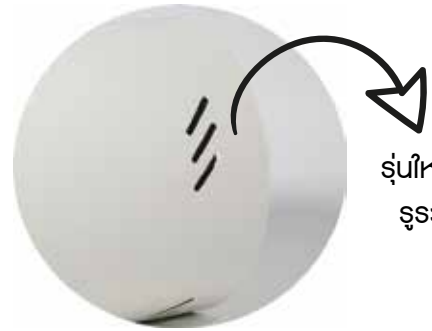

รุ่นใหม่ สิ้นลงและมี
รูระบายอากาศ

DOWNLIGHT

Surface Mounted Downlight

COLD-ROLL STEEL SHEET, COATED WITH POLYESTER POWDER

ALUMINIUM ANODIZED REFLECTOR

SURFACE MOUNTING OR PENDANT



DB-L171/WH
Ø16 x H16
E27x1
400.-



DB-L171/BK
Ø16 x H16
E27x1
400.-



DB-171G/WH
Ø16.5 x H18.5
E27x1
700.-

DB-171G/BK
Ø16.5 x H18.5
E27x1
700.-



DB-421/WH
W11.5 x L11.5 x H16
E27x1
400.-

DB-421/BK
W11.5 x L11.5 x H16
E27x1
400.-



DB-441/WH
W13.8 x L13.8 x H19
E27x1
450.-

DB-441/BK
W13.8 x L13.8 x H19
E27x1
450.-



DB-441/G/WH
W13.8 x L13.8 x H19
E27x1
600.-

DB-441/G/BK
W13.8 x L13.8 x H19
E27x1
600.-



DB-471/WH
W17 x L17 x H22
E27x1
650.-

DB-471/BK
W17 x L17 x H22
E27x1
650.-

DOWNLIGHT

Surface Mounted Downlight

COLD-ROLL STEEL SHEET, COATED WITH POLYESTER POWDER

ALUMINIUM ANODIZED REFLECTOR

SURFACE MOUNTING OR PENDANT



DB-5600-1
Ø9.5 x H12.5
GU10 x 1
1,100.-



DB-5600-2
W17.8 x L9.5 x H12.8
GU10 x 1
2,000.-



DB-5602
W9.5 x L19 x H12.5
GU10 x 2
2,200.-

DOWNLIGHT

Surface Mounted Downlight

COLD-ROLL STEEL SHEET, COATED WITH POLYESTER POWDER

ALUMINIUM ANODIZED REFLECTOR

SURFACE MOUNTING OR PENDANT



DB-31511
W10 x L10 x H16
E27x1
1,200.-



DB-31611
W11 x L11 x H17
E27x1
1,200.-

DOWNLIGHT

Surface Mounted Downlight

COLD ROLL STEEL SHEET, COATED WITH POLYESTER POWDER
SURFACE MOUNTING OR PENDANT



DB-31711
W15 x L15 x H19
E27x1
1,800.-

DOWNLIGHT

Multiple Surface Downlight

COLD ROLL STEEL SHEET, COATED WITH POLYESTER POWDER

SURFACE MOUNTING OR PENDANT



DB-33111
W14 x L14 x H17
QR111x1
1,500.-



12x12



DB-33112
W14 x L28 x H17
QR111x2
2,500.-



12x26



DB-N116-1
W13.6 x L13.6 x H19
E27x1
1,000.-



DB-N116-2
W13.5 x L27 x H19
E27x2
1,840.-

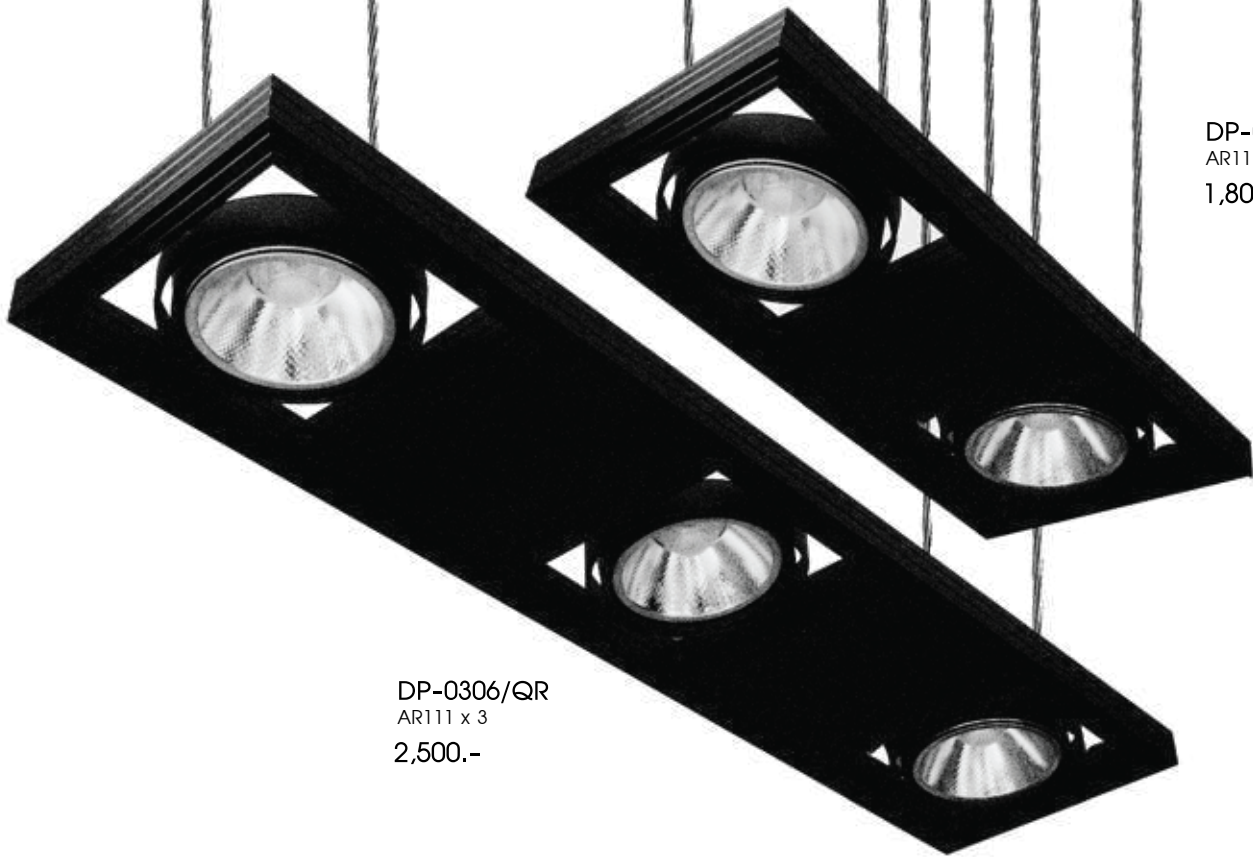

DP-0206/QR
AR111 x 2
1,800.-

DP-0306/QR
AR111 x 3
2,500.-

DOWNLIGHT

Multiple Hanging Downlight

ALUMINIUM, COATED WITH POLYESTER POWDER

SUITABLE FOR SHOP, HOTEL, SHOWROOM, STORE DECORATION

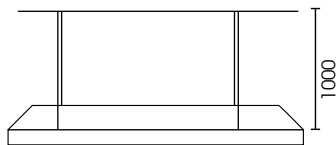
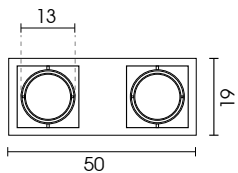

**ສລິງຍາວ 1 ແມັດ

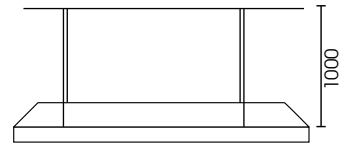
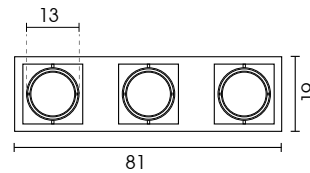

**ສລິງຍາວ 1 ແມັດ



DOWNLIGHT

Surface Mounted Downlight

COLD-ROLL STEEL SHEET, COATED WITH POLYESTER POWDER

ALUMINIUM ANODIZED REFLECTOR

SURFACE MOUNTING OR PENDANT



DB-3902/B/BK
Ø22.5 x H21.7
E27x1
1,800,-



DL-4101

Multiple Recessed Downlight

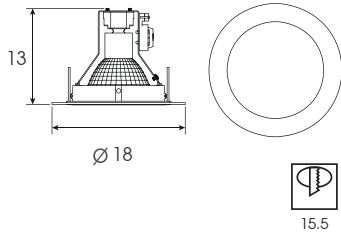

DL-4100

Multiple Recessed Downlight

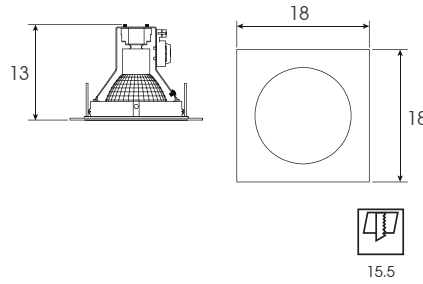

DL-4200

2-Multiple Recessed Downlight

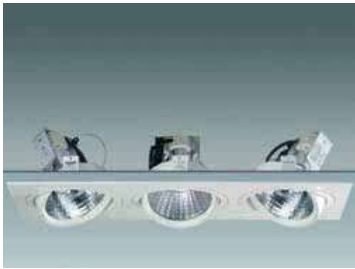
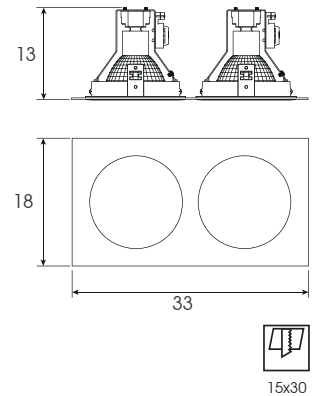

DL-4300



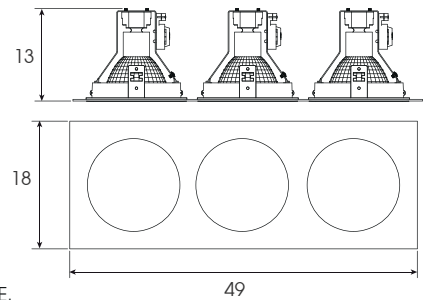















3-Multiple Recessed Downlight



COLD-ROLL STEEL SHEET, COATED WITH POLYESTER POWDER
 RECESSED T-BAR OR GYPSUM MOUNTING
 SUITABLE FOR SHOP, HOTEL, SHOWROOM, STORE DECORATION

MAGIC BOX SERIES

1. THE BOARDS ARE MADE OF QUALITY ALUMINIUM MATERIAL. AND DIFFERENT COLORS ARE AVAILABLE.
2. THE ANGLE OG LIGHT SOURCES IS ADJUSTABLE.
3. THIS SERIES COULD BE WITH DIFFERENT LIGHT SOURCES, SUCH AS QR111, G12, PAR30 AND E27.
4. BALLAST BOX NEEDS TO BE CONNECTED.
5. FRONT RING CAN BE TURNED OUT FOR CHANGING SOURCE.

MODEL NO.	LAMP HOLDER	COMPATIBLE BULB	PRICE								
 DL-4100-G12	G12	<table border="1"> <tr> <th colspan="2">Compatible Bulb</th> </tr> <tr> <td></td> <td>CDM-T / G12 35W / 70W / 150W</td> </tr> </table>	Compatible Bulb			CDM-T / G12 35W / 70W / 150W	1,000.-				
Compatible Bulb											
	CDM-T / G12 35W / 70W / 150W										
 DL-4100-P30	E27	<table border="1"> <tr> <th colspan="2">Compatible Bulb</th> <th colspan="2">LED Replacement</th> </tr> <tr> <td></td> <td>PAR30 / E27 75W</td> <td></td> <td>LED-PAR30 / E27 12W / 15W</td> </tr> </table>	Compatible Bulb		LED Replacement			PAR30 / E27 75W		LED-PAR30 / E27 12W / 15W	600.-
Compatible Bulb		LED Replacement									
	PAR30 / E27 75W		LED-PAR30 / E27 12W / 15W								
 DL-4100-QR111	G53	<table border="1"> <tr> <th colspan="2">Compatible Bulb</th> <th colspan="2">LED Replacement</th> </tr> <tr> <td></td> <td>QR111 / G53 12V 50 / 75 / 100W</td> <td></td> <td>LED-QR111 / G53 12W / 15W</td> </tr> </table>	Compatible Bulb		LED Replacement			QR111 / G53 12V 50 / 75 / 100W		LED-QR111 / G53 12W / 15W	350.-
Compatible Bulb		LED Replacement									
	QR111 / G53 12V 50 / 75 / 100W		LED-QR111 / G53 12W / 15W								

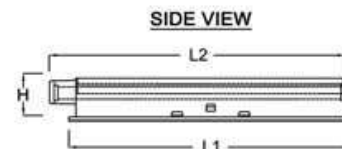
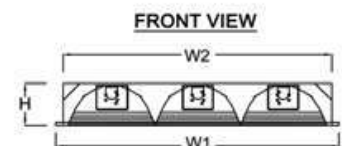

F-LOR

T8 Recessed Louver Luminaire

HOUSING

- MADE OF HIGH QUALITY COLD-ROLLED STEEL SHEET OF THICKNESS 0.6 OR 0.4MM.
- FIVE-STAGE ZINC PHOSPHATE PRETREATMENT FOR RUST RESISTANCE.
- FINISHED WITH WHITE POLYESTER POWDER BY TWO-STAGE ELECTROSTATIC METHOD.
- HEAVY DUTY ROTARY-LOCKED TYPE (G13) LAMP HOLDER (TIS.344-1987 STANDARD)
- ROTARY-LOCKED TYPE STARTER HOLDER (TIS STANDARD)
- CABLE THW (TIS.11-1988 STANDARD)

INSTALLATION & APPLICATION

- FOR RECESSED T-BAR AND GYPSUM CEILING INSTALLATION.
- RECOMMENDED FOR COMMERCIAL BUILDINGS, SHOPS, HOSPITALS, DEPARTMENT STORES, SCHOOLS, ETC



MODEL NO	WATT	DIMENSION (MM.)					CUT OUT (MM.)	REMARK
		L1	L2	W1	W2	H		
F-LOR118	1 X T8 18W	595	620	200	170	80	575 X 185	
F-LOR118/30	1 X T8 18W	595	620	295	265	80	575 X 275	
F-LOR218	2 X T8 18W	595	620	295	265	80	575 X 275	
F-LOR218/60	2 X T8 18W	595	620	595	565	80	575 X 575	
F-LOR318	3 X T8 18W	595	620	595	565	80	575 X 575	
F-LOR418	4 X T8 18W	595	620	595	565	80	575 X 575	
F-LOR136	1 X T8 36W	1195	1222	200	170	80	1175 X 185	
F-LOR136/30	1 X T8 36W	1195	1222	295	265	80	1175 X 275	
F-LOR236	2 X T8 36W	1195	1222	295	265	80	1175 X 275	
F-LOR236/60	2 X T8 36W	1195	1222	595	565	80	1175 X 575	
F-LOR336	3 X T8 36W	1195	1222	595	565	80	1175 X 575	
F-LOR436	4 X T8 36W	1195	1222	595	565	80	1175 X 575	

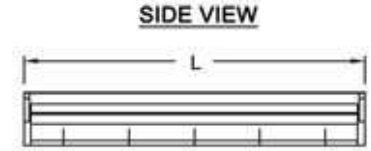
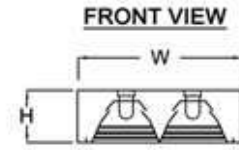

F-LOS

T8 Recessed Louver Luminaire

HOUSING

- MADE OF HIGH QUALITY COLD-ROLLED STEEL SHEET OF THICKNESS 0.6 OR 0.4 MM.
- FIVE-STAGE ZINC PHOSPHATE PRETREATMENT FOR RUST RESISTANCE.
- FINISHED WITH WHITE POLYESTER POWDER BY TWO-STAGE ELECTROSTATIC METHOD.
- HEAVY DUTY ROTARY-LOCKED TYPE (G13) LAMP HOLDER (TIS.344-1987 STANDARD)
- ROTARY-LOCKED TYPE STARTER HOLDER (TIS STANDARD)
- CABLE THW (TIS.11-1988 STANDARD)

INSTALLATION & APPLICATION

- FOR SURFACE CEILING INSTALLATION.
- RECOMMENDED FOR COMMERCIAL BUILDINGS, SHOPS, HOSPITALS, DEPARTMENT STORES, SCHOOLS, ETC



MODEL NO	WATT	DIMENSION (MM.)			REMARK
		L	W	H	
F-LOS118	1 X T8 18W	615	200	80	
F-LOS118/30	1 X T8 18W	615	295	80	
F-LOS218	2 X T8 18W	615	295	80	
F-LOS218/60	2 X T8 18W	615	595	80	
F-LOS318	3 X T8 18W	615	595	80	
F-LOS418	4 X T8 18W	615	595	80	
F-LOS136	1 X T8 36W	1222	200	80	
F-LOS136/30	1 X T8 36W	1222	295	80	
F-LOS236	2 X T8 36W	1222	295	80	
F-LOS236/60/T8	2 X T8 36W	1222	595	80	
F-LOS236/60	2 X T8 36W	1222	595	80	
F-LOS336	3 X T8 36W	1222	595	80	
F-LOS436	4 X T8 36W	1222	595	80	

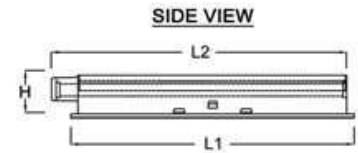
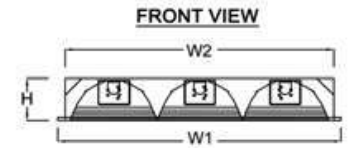

F-LOR/TP

T8 Recessed Louver Luminaire

HOUSING

- MADE OF HIGH QUALITY COLD-ROLLED STEEL SHEET OF THICKNESS 0.6 OR 0.4MM.
- FIVE-STAGE ZINC PHOSPHATE PRETREATMENT FOR RUST RESISTANCE.
- FINISHED WITH WHITE POLYESTER POWDER BY TWO-STAGE ELECTROSTATIC METHOD.
- HEAVY DUTY ROTARY-LOCKED TYPE (G13) LAMP HOLDER (TIS.344-1987 STANDARD)
- ROTARY-LOCKED TYPE STARTER HOLDER (TIS STANDARD)
- CABLE THW (TIS.11-1988 STANDARD)

INSTALLATION & APPLICATION

- FOR RECESSED T-BAR AND GYPSUM CEILING INSTALLATION.
- RECOMMENDED FOR COMMERCIAL BUILDINGS, SHOPS, HOSPITALS, DEPARTMENT STORES, SCHOOLS, ETC



MODEL NO	WATT	DIMENSION (MM.)					CUT OUT (MM.)	REMARK
		L1	L2	W1	W2	H		
F-LOR118/TP	1 X T8 18W	595	620	200	170	80	575 X 185	
F-LOR118/30/TP	1 X T8 18W	595	620	295	265	80	575 X 275	
F-LOR218/TP	2 X T8 18W	595	620	295	265	80	575 X 275	
F-LOR218/60/TP	2 X T8 18W	595	620	595	565	80	575 X 575	
F-LOR318/TP	3 X T8 18W	595	620	595	565	80	575 X 575	
F-LOR418/TP	4 X T8 18W	595	620	595	565	80	575 X 575	
F-LOR136/TP	1 X T8 36W	1195	1222	200	170	80	1175 X 185	
F-LOR136/30/TP	1 X T8 36W	1195	1222	295	265	80	1175 X 275	
F-LOR236/TP	2 X T8 36W	1195	1222	295	265	80	1175 X 275	
F-LOR236/60/TP	2 X T8 36W	1195	1222	595	565	80	1175 X 575	
F-LOR336/TP	3 X T8 36W	1195	1222	595	565	80	1175 X 575	
F-LOR436/TP	4 X T8 36W	1195	1222	595	565	80	1175 X 575	

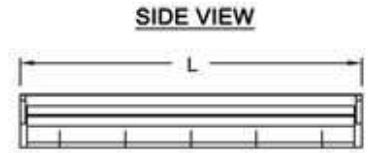
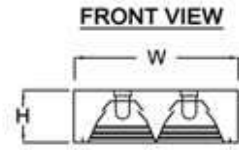

F-LOS/TP

T8 Recessed Louver Luminaire

HOUSING

- MADE OF HIGH QUALITY COLD-ROLLED STEEL SHEET OF THICKNESS 0.6 OR 0.4 MM.
- FIVE-STAGE ZINC PHOSPHATE PRETREATMENT FOR RUST RESISTANCE.
- FINISHED WITH WHITE POLYESTER POWDER BY TWO-STAGE ELECTROSTATIC METHOD.
- HEAVY DUTY ROTARY-LOCKED TYPE (G13) LAMP HOLDER (TIS.344-1987 STANDARD)
- ROTARY-LOCKED TYPE STARTER HOLDER (TIS STANDARD)
- CABLE THW (TIS.11-1988 STANDARD)

INSTALLATION & APPLICATION

- FOR SURFACE CEILING INSTALLATION.
- RECOMMENDED FOR COMMERCIAL BUILDINGS, SHOPS, HOSPITALS, DEPARTMENT STORES, SCHOOLS, ETC



MODEL NO	WATT	DIMENSION (MM.)			REMARK
		L	W	H	
F-LOS118/TP	1 X T8 18W	615	200	80	
F-LOS118/30/TP	1 X T8 18W	615	295	80	
F-LOS218/TP	2 X T8 18W	615	295	80	
F-LOS218/60/TP	2 X T8 18W	615	595	80	
F-LOS318/TP	3 X T8 18W	615	595	80	
F-LOS418/TP	4 X T8 18W	615	595	80	
F-LOS136/TP	1 X T8 36W	1222	200	80	
F-LOS136/30/TP	1 X T8 36W	1222	295	80	
F-LOS236/TP	2 X T8 36W	1222	295	80	
F-LOS236/60/TP	2 X T8 36W	1222	595	80	
F-LOS336/TP	3 X T8 36W	1222	595	80	
F-LOS436/TP	4 X T8 36W	1222	595	80	

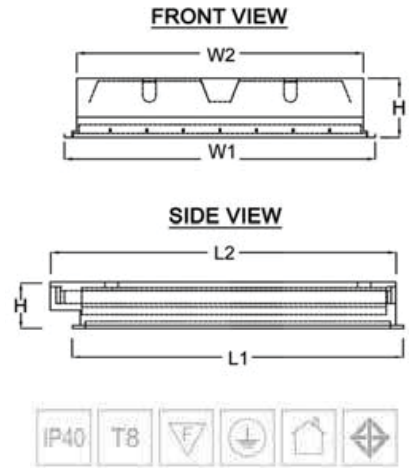

F-LORP

T8 Recessed Louver Luminaire

HOUSING

- MADE OF HIGH QUALITY COLD-ROLLED STEEL SHEET OF THICKNESS 0.6 OR 0.4 MM.
- FIVE-STAGE ZINC PHOSPHATE PRETREATMENT FOR RUST RESISTANCE.
- FINISHED WITH WHITE POLYESTER POWDER BY TWO-STAGE ELECTROSTATIC METHOD.
- HEAVY DUTY ROTARY-LOCKED TYPE (G13) LAMP HOLDER (TIS.344-1987 STANDARD)
- ROTARY-LOCKED TYPE STARTER HOLDER (TIS STANDARD)
- CABLE THW (TIS.11-1988 STANDARD)

INSTALLATION & APPLICATION

- FOR RECESSED T-BAR AND GYPSUM CEILING INSTALLATION.
- RECOMMENDED FOR COMMERCIAL BUILDINGS, SHOPS, HOSPITALS, DEPARTMENT STORES, SCHOOLS, ETC



PRISMATIC (PR)

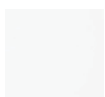

OPAL (OP)



CLEAR (CL)

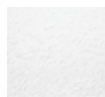

STIPPLE (ST)

MODEL NO	WATT	DIMENSION (MM.)					CUT OUT (MM.)	REMARK
		L1	L2	W1	W2	H		
F-LORP118	1 X T8 18W	595	620	200	170	100	575 X 185	
F-LORP118/30	1 X T8 18W	595	620	295	265	100	575 X 275	
F-LORP218	2 X T8 18W	595	620	295	265	100	575 X 275	
F-LORP218/60	2 X T8 18W	595	620	595	565	100	575 X 575	
F-LORP318	3 X T8 18W	595	620	595	565	100	575 X 575	
F-LORP418	4 X T8 18W	595	620	595	565	100	575 X 575	
F-LORP136	1 X T8 36W	1195	1222	200	170	100	1175 X 185	
F-LORP136/30	1 X T8 36W	1195	1222	295	265	100	1175 X 275	
F-LORP236	2 X T8 36W	1195	1222	295	265	100	1175 X 275	
F-LORP236/60	2 X T8 36W	1195	1222	595	565	100	1175 X 575	
F-LORP336	3 X T8 36W	1195	1222	595	565	100	1175 X 575	
F-LORP436	4 X T8 36W	1195	1222	595	565	100	1175 X 575	

F-LORP___/B/A

B = ACRYLIC TYPE (PR, OP, ST, CL)

A = REFLECTANCE OF ALUMINIUM REFLECTOR (87=87% , 95=95%)

ถ้าไม่มี คือ ไม่มี REFLECTOR

FLUORESCENT

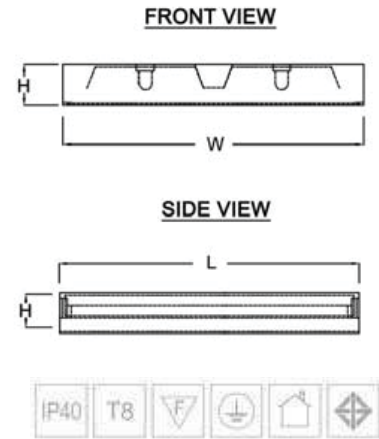

F-LOSP

T8 Surface Mounted Acrylic Diffuser Luminaire

HOUSING

- MADE OF HIGH QUALITY COLD-ROLLED STEEL SHEET OF THICKNESS 0.6 OR 0.4 MM.
- FIVE-STAGE ZINC PHOSPHATE PRETREATMENT FOR RUST RESISTANCE.
- FINISHED WITH WHITE POLYESTER POWDER BY TWO-STAGE ELECTROSTATIC METHOD.
- HEAVY DUTY ROTARY-LOCKED TYPE (G13) LAMP HOLDER (TIS.344-1987 STANDARD)
- ROTARY-LOCKED TYPE STARTER HOLDER (TIS STANDARD)
- CABLE THW (TIS.11-1988 STANDARD)

INSTALLATION & APPLICATION

- FOR SURFACE CEILING INSTALLATION.
- RECOMMENDED FOR COMMERCIAL BUILDINGS, SHOPS, HOSPITALS, DEPARTMENT STORES, SCHOOLS, ETC



MODEL NO	WATT	DIMENSION (MM.)			REMARK
		L	W	H	
F-LOSP118	1 X T8 18W	615	200	82	
F-LOSP118/30	1 X T8 18W	615	295	82	
F-LOSP218	2 X T8 18W	615	295	82	
F-LOSP218/60	2 X T8 18W	615	595	82	
F-LOSP318	3 X T8 18W	615	595	82	
F-LOSP418	4 X T8 18W	615	595	82	
F-LOSP136	1 X T8 36W	1222	200	82	
F-LOSP136/30	1 X T8 36W	1222	295	82	
F-LOSP236	2 X T8 36W	1222	295	82	
F-LOSP236/60	2 X T8 36W	1222	595	82	
F-LOSP336	3 X T8 36W	1222	595	82	
F-LOSP436	4 X T8 36W	1222	595	82	

F-LORP____/B/A

B = ACRYLIC TYPE (PR, OP, ST, CL)

A = REFLECTANCE OF ALUMINIUM REFLECTOR (87=87% , 95=95%)

ถ้าไม่มี คือ ไม่มี REFLECTOR



F-CURVE1

Recessed Mounted Luminaire

HOUSING

- MADE OF HIGHT QUALITY COLD-ROLLED STEEL SHEET OF THICKNESS 0.6 (T6)
- FIVE-STAGE ZINC PHOSPHATE PRETRATMENT FOR RUST RESISTANCE.
- FINISHED WITH WHITE POLYESTER POWDER BY TWO-STAGE ELECTROSTATIC METHOD.
- HEAVY DUTY ROTARY-LOCKED TYPE (G13) LAMP HOLDER (TIS.344-1987 STANDARD).
- ROTARY-LOCKED TYPE STARTER HOLDER (TIS STANDARD).
- SPRING-LOCK TYPE FRAME FOR EASE OF MAINTENANCE.

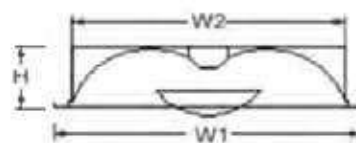

MODEL NO	WATT	DIMENSION (MM.)					CUT OUT (MM.)
		L1	L2	W1	W2	H	
F-CURVE1-218F	2 X T8 18W	620	595	595	565	115	575 X 575
F-CURVE1-236F	2 X T8 36W	1220	1195	595	565	115	1172 X 575



F-CURVE-V

Recessed Mounted Luminaire

HOUSING

- MADE OF HIGHT QUALITY COLD-ROLLED STEEL SHEET OF THICKNESS 0.6 (T6)
- FIVE-STAGE ZINC PHOSPHATE PRETRATMENT FOR RUST RESISTANCE.
- FINISHED WITH WHITE POLYESTER POWDER BY TWO-STAGE ELECTROSTATIC METHOD.
- HEAVY DUTY ROTARY-LOCKED TYPE (G13) LAMP HOLDER (TIS.344-1987 STANDARD).
- ROTARY-LOCKED TYPE STARTER HOLDER (TIS STANDARD).
- SPRING-LOCK TYPE FRAME FOR EASE OF MAINTENANCE.

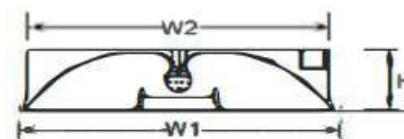

MODEL NO	WATT	DIMENSION (MM.)					CUT OUT (MM.)
		L1	L2	W1	W2	H	
F-CURVE-V-218F	2 X T8 18W	620	595	595	565	100	605 X 580
F-CURVE-V-236F	2 X T8 36W	1220	1195	595	565	100	1205 X 575

F-FRAME

Recessed Mounted with Downlight Luminaire

HOUSING

- MADE OF HIGH QUALITY COLD-ROLLED STEEL SHEET OF THICKNESS 0.6 (T6)
- FIVE-STAGE ZINC PHOSPHATE PRETREATMENT FOR RUST RESISTANCE.
- FINISHED WITH WHITE POLYESTER POWDER BY TWO-STAGE ELECTROSTATIC METHOD.
- HEAVY DUTY ROTARY-LOCKED TYPE (G13) LAMP HOLDER (TIS,344-1987 STANDARD)
- DUAL QR111 DOWNLIGHT ON BOTH END (OPTIONAL : OTHER DOWNLIGHTS ARE AVAILABLE UPON REQUEST)
- 99.85% HIGH PURITY ANODIZED ALUMINIUM REFLECTOR WITH TOTAL REFLECTANCE OF 87% (87)
- OPAL ACRYLIC DIFFUSER FOR SMOOTH LIGHT DISTRIBUTION

MODEL NO	WATT	DIMENSION (MM.)				
		L1	L2	W1	W2	H
F-FRAME136/QR	1 X T8 36W	1646	1622	206	180	140
F-FRAME236/QR	2 X T8 36W	1646	1622	206	180	140

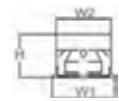

F-HB

T8, Acrylic Diffuser Type Fluorescent High Bay

HOUSING

- Made of high quality cold-rolled steel sheet of thickness 0.6 (T6) or 0.8mm.(T8).
- Five-stage zinc phosphate pretreatment for rust resistance.
- Finished with white polyester powder by two-stage electrostatic method.
- Heavy duty rotary-locked type (GS) lamp holder (TIS.34-1987 Standard)
- Cable THW 1.0 sq.mm. 70°C (TIS.11-1988 Standard). Optional: 10S°C 18AWG UL Standard.

INSTALLATION & APPLICATION

- For surface mounted or suspension rods installation.
- Recommended for warehouses, factories, gymnasium, etc.

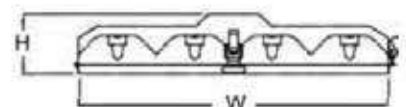

MODEL NO	WATT	DIMENSION (MM.)			REMARK
		L	W	H	
F-HB336/NA/87	3 X T8 36W	1222	525	94	
F-HB436/NA/87	4 X T8 36W	1222	525	94	
F-HB636/NA/87	6 X T8 36W	1222	525	94	
F-HB336/CL/87	3 X T8 36W	1222	525	94	
F-HB436/CL/87	4 X T8 36W	1222	525	94	





F-A

T8 Batten Type Luminaire

HOUSING

- HIGH QUALITY COLD- ROLLED STEEL HOUSING OF THICKNESS 0.4
- FIVE-STAGE ZINC PHOSPHATE PRETREATMENT FOR RUST RESISTANCE.
- FINISHED WITH WHITE POLYESTER POWDER BY TWO-STAGE ELECTROSTATIC METHOD.
- ROTARY-LOCKED TYPE STARTER HOLDER (TIS.344-1987 STANDARD)
- CABLE THW (TIS.11-1988 STANDARD)

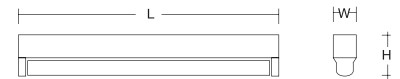

MODEL NO	WATT	DIMENSION (MM.)		
		L	W	H
F-L60	1 X T8 LED	600	33	17
F-L120	1 X T8 LED	1200	33	17
F-A118	1 X T8 18W	636	60	97
F-A218	2 X T8 18W	636	120	97
F-A136	1 X T8 36W	1245	60	97
F-A236	2 X T8 36W	1245	120	97



F-R

T8 Asymmetric Batten Type Luminaire

HOUSING

- HIGH QUALITY COLD-ROLLED STEEL HOUSING OF 0.4MM.
- FIVE-STAGE ZINC PHOSPHATE PRETREATMENT FOR RUST RESISTANCE.
- FINISHED WITH WHITE POLYESTER POWDER BY TWO-STAGE ELECTROSTATIC METHOD.
- ROTARY-LOCKED TYPE STARTER HOLDER (TIS.344-1987 STANDARD)
- HEAVY DUTY LAMP HOLDER (TIS.344-1987 STANDARD)
- CABLE THW (TIS.11-1988 STANDARD)



MODEL NO	WATT	DIMENSION (MM.)		
		L	W	H
F-R118	1 X T8 18W	636	60	133
F-R136	1 X T8 36W	1245	60	133

F-WING

Surface Mounted Luminaire

HOUSING

- MADE OF HIGH QUALITY COLD-ROLLED STEEL SHEET OF THICKNESS 0.6 (T8)
- FIVE-STAGE ZINC PHOSPHATE PRETREATMENT FOR RUST RESISTANCE.
- FINISHED WITH WHITE POLYESTER POWDER BY TWO-STAGE ELECTROSTATIC METHOD.
- HEAVY DUTY ROTARY-LOCKED TYPE (G13) LAMP HOLDER (TIS.344-1987 STANDARD)
- ROTARY-LOCKED TYPE STARTER HOLDER (TIS STANDARD) FOR T8 LAMP

MODEL NO	WATT	DIMENSION (MM.)		
		L	W	H
F-WING218F	2 X T8 18W	630	295	115
F-WING236F	2 X T8 36W	1240	295	115

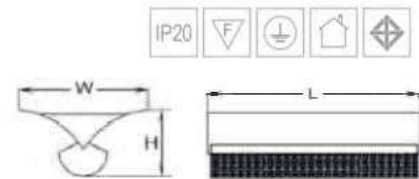

F-U

T8 U-Type Acrylic Diffuser Luminaire

HOUSING

- INJECTED POLYCARBONATE(PC) IN GREY COLOR WITH INJECTION MOLDED CLEAR PRISMATIC UV STABILIZED POLYCARBONATE (PC) WITH CURVED TO ANTI-GLARE.
- COLD-ROLLED STEEL PLATE, FINISHED WITH HIGH GLOSSY BAKED WHITE POLYESTER POWDER COATING
- STAINLESS CLIP LOCK (SL). OPTINAL: POLYCARBONATE (PC) CLIP LOCK
- ROTARY-LOCKED TYPE LAMP HOLDER G13 (TIS.344-1987 STANDARD)
- ROTARY-LOCKED TYPE STARTER HOLDER (TIS.344-1987 STANDARD)
- CABLE THW (TIS.11-1988 STANDARD).
- SUITABLE FOR SEMI-OUTDOOR OR OUTDOOR APPLICATION

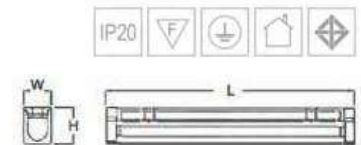

MODEL NO	WATT	DIMENSION (MM.)		
		L	W	H
F-U118	1 X T8 18W.	636	70	80
F-U218	2 X T8 18W.	636	200	80
F-U136	1 X T8 36W.	1245	70	80
F-U236	2 X T8 36W.	1245	200	80



F-FW/F-FAL

T8 Industrial Type Luminaire

HOUSING

- HIGH QUALITY COLD-ROLLED STEEL HOUSING OF THICKNESS 0.4MM.
- FIVE-STAGE ZINC PHOSPHATE PRETREATMENT FOR RUST RESISTANCE.
- FINISHED WITH WHITE POLYESTER POWDER BY TWO-STAGE ELECTROSTATIC METHOD.
- POWDER PAINTED SHEEL SHEET REFLECTOR. OPTIONAL: 99.85% HIGH PURTTY ANODIZED ALUMINIUM REFLECTOR WITH TOTAL REFLECTANCE OF 87%(87) OR 95%(95)
- ROTARY-LOCKED TYPE STARTER HOLDER (TIS.344-1987 STANDARD)
- HEAVY DUTY LAMP HOLDER (TIS.344-1987 STANDARD)
- CABLE THW TIS.11-1988 STANDARD).
- SUITABLE FOR GENERAL PURPOSE WITH HIGH EFFICIENCY REQUIREMENT

MODEL NO	WATT	DIMENSION (MM.)			
		L1	W1	W2	H
F-FW118	1 X T8 18W	636	135	60	101
F-FAL118	1 X T8 18W	636	135	60	101
F-FW218	2 X T8 18W	636	230	120	101
F-FAL218	2 X T8 36W	636	230	120	101
F-FW136	1 X T8 36W	1245	135	60	101
F-FAL136	1 X T8 36W	1245	135	60	101
F-FW236	2 X T8 36W	1245	230	120	101
F-FAL236	2 X T8 36W	1245	230	120	101

F-FAL

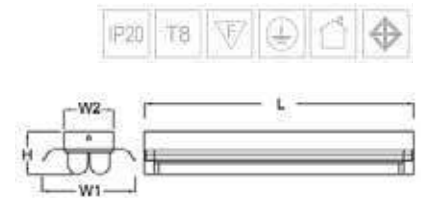

F-V

T8 Taper Batten Type Luminaire

HOUSING

- HIGH QUALITY COLD-ROLLED STEEL HOUSING OF THICKNESS 0.4MM.
- FIVE-STAGE ZINC PHOSPHATE PRETREATMENT FOR RUST RESISTANCE.
- FINISHED WITH WHITE POLYESTER POWDER BY TWO-STAGE ELECTROSTATIC METHOD.
- ROTARY-LOCKED TYPE STARTER HOLDER (TIS.344-1987 STANDARD)
- HEAVY DUTY LAMP HOLDER (TIS.344-1987 STANDARD)
- CABLE THW (TIS.11-1988 STANDARD).
- SUITABLE FOR GENERAL PURPOSE WITH HIGH EFFICIENCY REQUIREMENT

MODEL NO	WATT	DIMENSION (MM.)		
		L	W	H
F-V118	1 X T8 18W	636	155	115
F-V218	2 X T8 18W	636	155	90
F-V136	1 X T8 36W	1245	155	115
F-V236	2 X T8 36W	1245	155	90

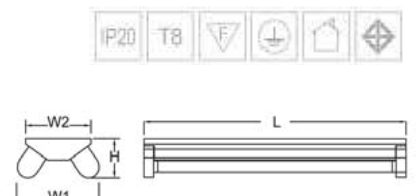



F-WP-E218

T8 Weather Proof Luminaire

HOUSING

- INJECTED POLYCARBONATE(PC) IN GREY COLOR WITH INJECTION MOLDED CLEAR PRISMATIC UV STABILIZED POLYCARBONATE (PC) WITH CURVED TO ANTI-GLARE.
- COLD-ROLLED STEEL PLATE, FINISHED WITH HIGH GLOSSY BAKED WHITE POLYESTER POWDER COATING
- STAINLESS CLIP LOCK (SL). OPTINAL: POLYCARBONATE (PC) CLIP LOCK
- ROTARY-LOCKED TYPE LAMP HOLDER G13 (TIS.344-1987 STANDARD)
- CABLE THW (TIS.11-1988 STANDARD).
- SUITABLE FOR SEMI-OUTDOOR OR OUTDOOR APPLICATION

MODEL NO	WATT	DIMENSION (MM.)		
		L	W	H
F-WP-E218	2 X T8 LED	1267	110	60

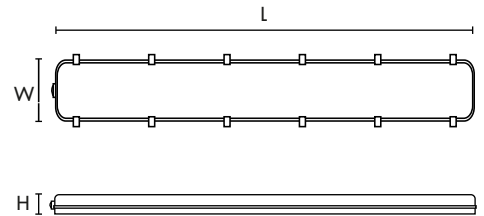

คุณสมบัติ

- ระบายความร้อนได้ดี
- ระดับการกระแทก IK08
- ระดับกันน้ำ กันฝุ่น IP65
- ฝาครอบพลาสติกอย่างดี ป้องกัน UV

ประโยชน์ที่ได้รับ

- เนื่องจากมีระดับการกันน้ำ กันฝุ่น ถึง IP65
- จึงเหมาะกับการใช้งานภายนอก
- ทนแรงกระแทกได้
- ฝาครอบป้องกันการเปลี่ยนสี

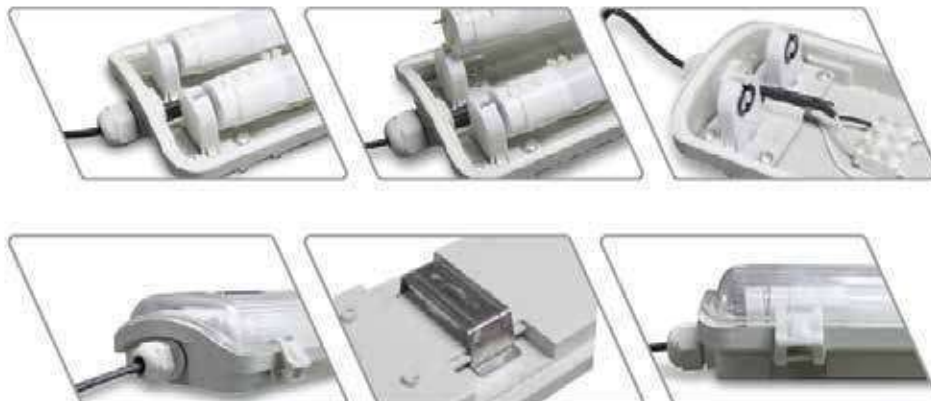

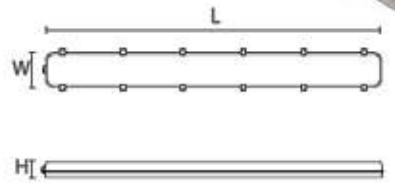

F-WP-E

T8 Weather Proof Luminaire

HOUSING

- INJECTED POLYCARBONATE(PC) IN GREY COLOR WITH INJECTION MOLDED CLEAR PRISMATIC UV STABILIZED POLYCARBONATE (PC) WITH CURVED TO ANTI-GLARE.
- COLD-ROLLED STEEL PLATE, FINISHED WITH HIGH GLOSSY BAKED WHITE POLYESTER POWDER COATING
- STAINLESS CLIP LOCK (SL). OPTINAL: POLYCARBONATE (PC) CLIP LOCK
- ROTARY-LOCKED TYPE LAMP HOLDER G13 (TIS.344-1987 STANDARD)
- CABLE THW (TIS.11-1988 STANDARD).
- SUITABLE FOR SEMI-OUTDOOR OR OUTDOOR APPLICATION

OPTIONAL: ANODIZED ALUMINIUM REFLECTOR TR 87% MIRROR FINISHED

MODEL NO	WATT	DIMENSION (MM.)		
		L	W	H
F-WP-E109	1 X T8 LED	670	85	60
F-WP-E118	1 X T8 LED	1280	85	60



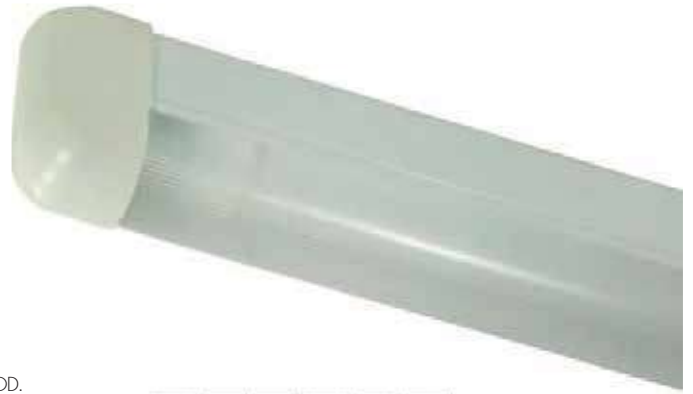

F-COMPACT1

T8 U-Shape Acrylic Guard Batten Type Luminaire

HOUSING

- FIVE-STAGE ZINC PHOSPHATE PRETREATMENT FOR RUST RESISTANCE.
- FINISHED WITH WHITE POLYESTER POWDER BY TWO-STAGE ELECTROSTATIC METHOD.
- HIGH QUALITY ACRYLIC DIFFUSER WITH STEEL PAINTED FRAME.
- HEAVY DUTY ROTARY LOCKED TYPE LAMP HOLDER (TIS.344-1987 STANDARD)
- CABLE THW (TIS.11-1988 STANDARD).
- SUITABLE FOR GENERAL PURPOSE WITH HIGH EFFICIENCY REQUIREMENT

IP40 T8



MODEL NO	WATT	DIMENSION (MM.)		
		L	W	H
F-COMPACT1-118-P	1 X T8 18W	645	47	70
F-COMPACT2-118-P	1 X T8 18W	645	47	70
F-COMPACT1-136-P	1 X T8 36W	1250	47	70

โคมเปล้าสำหรับใส่หลอด LED



F-COMPACT

T8 U-Shape Acrylic Guard Batten Type Luminaire

HOUSING

- FIVE-STAGE ZINC PHOSPHATE PRETREATMENT FOR RUST RESISTANCE.
- FINISHED WITH WHITE POLYESTER POWDER BY TWO-STAGE ELECTROSTATIC METHOD.
- HIGH QUALITY ACRYLIC DIFFUSER WITH STEEL PAINTED FRAME.
- HEAVY DUTY ROTARY LOCKED TYPE LAMP HOLDER (TIS.344-1987 STANDARD)
- CABLE THW (TIS.11-1988 STANDARD).
- SUITABLE FOR GENERAL PURPOSE WITH HIGH EFFICIENCY REQUIREMENT

IP40 T8



MODEL NO	WATT	DIMENSION (MM.)		
		L	W	H
F-COMPACT118	1 X T8 18W	636	45	90
F-COMPACT118-P	1 X T8 18W	636	45	90
F-COMPACT136	1 X T8 36W	1240	45	90
F-COMPACT136-P	1 X T8 36W	1240	45	90

โคมเปล้าสำหรับใส่หลอด LED



F-WG/S

T8 Wire-Guard Luminaire

HOUSING

- HIGH QUALITY COLD- ROLLED STEEL HOUSING OF THICKNESS 0.6
- FIVE-STAGE ZINC PHOSPHATE PRETREATMENT FOR RUST RESISTANCE.
- FINISHED WITH WHITE POLYESTER POWDER BY TWO-STAGE ELECTROSTATIC METHOD.
- ROTARY-LOCKED TYPE STARTER HOLDER (TIS.344-1987 STANDARD)
- CABLE THW (TIS.11-1988 STANDARD)

MODEL NO	WATT	DIMENSION (MM.)		
		L	W	H
F-WG118/S	1 X T8 18W	625	60	100
F-WG136/S	1 X T8 36W	1250	60	100
F-WG236/S	2 X T8 36W	1250	120	100

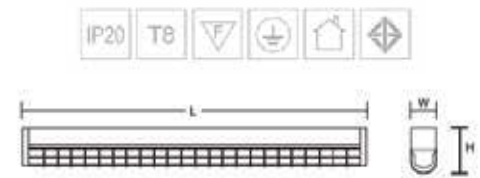

F-WGS

T8 Wire-Guard Luminaire

HOUSING

- HIGH QUALITY COLD- ROLLED STEEL HOUSING OF THICKNESS 0.6
- FIVE-STAGE ZINC PHOSPHATE PRETREATMENT FOR RUST RESISTANCE.
- FINISHED WITH WHITE POLYESTER POWDER BY TWO-STAGE ELECTROSTATIC METHOD.
- ROTARY-LOCKED TYPE STARTER HOLDER (TIS.344-1987 STANDARD)
- CABLE THW (TIS.11-1988 STANDARD)



ລວມ 3 MM.

MODEL NO	WATT	DIMENSION (MM.)		
		L	W	H
F-WGS136	1 X T8 36W	1230	58	98
F-WGS118	1 X T8 18W	630	58	98



F-HL-N220/P/BK

Pendant Aluminium Luminaire

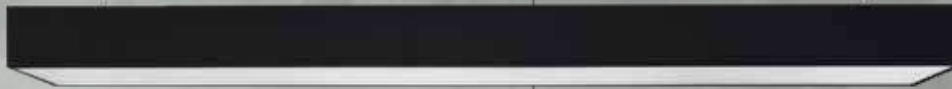

F-HL-N120/P/BK

Pendant Aluminium Luminaire

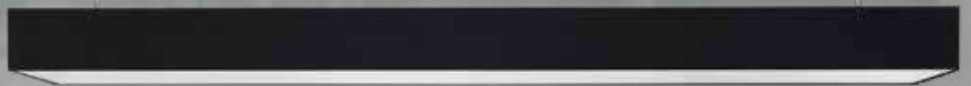

FLUORESCENT LAMP

HOUSING

- MADE OF HIGH QUALITY COLD-ROLLED STEEL SHEET OF THICKNESS 0,6 (T6)
- FINISHED WITH WHITE POLYESTER POWDER BY TWO-STAGE ELECTROSTATIC METHOD.
- HEAVY DUTY ROTARY-LOCKED TYPE (TIS.344-1987 STANDARD)
- OPAL ACRYLIC DIFFUSER FOR SMOOTH LIGHT DISTRIBUTION

MODEL NO	WATT	DIMENSION (MM.)		
		L	W	H
F-HL-N120/P/BK	1 X T8 LED.	1250	70	80
F-HL-N220/P/BK	2 X T8 LED	1250	140	80

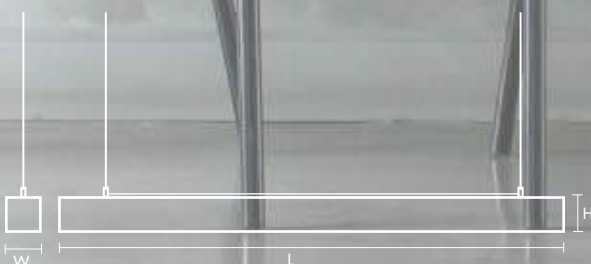

FLUORESCENT



F-HL-SLIM/P

Pendant Acrylic Luminaire

HOUSING

- MADE OF HIGH QUALITY COLD-ROLLED STEEL SHEET OF THICKNESS 0.6 (T6)
- FIVE-STAGE ZINC PHOSPHATE PRETREATMENT FOR RUST RESISTANCE.
- FINISHED WITH WHITE POLYESTER POWDER BY TWO-STAGE ELECTROSTATIC METHOD.
- HEAVY DUTY ROTARY-LOCKED TYPE (TIS.344-1987 STANDARD)
- OPAL ACRYLIC DIFFUSER FOR SMOOTH LIGHT DISTRIBUTION



MODEL NO	WATT	DIMENSION (MM.)		
		L	W	H
F-HL-SLIM120/P	1 X T8 18W	1245	100	100
F-HL-SLIM220/P	2 X T8 36W	1245	150	100



F-RS-SLIM/P

T8 Recessed Acrylic Diffuser Luminaire

HOUSING

- MADE OF HIGH QUALITY COLD-ROLLED STEEL SHEET OF THICKNESS 0.6 (T6)
- FIVE-STAGE ZINC PHOSPHATE PRETREATMENT FOR RUST RESISTANCE.
- FINISHED WITH WHITE POLYESTER POWDER BY TWO-STAGE ELECTROSTATIC METHOD.
- HEAVY DUTY ROTARY-LOCKED TYPE (TIS.344-1987 STANDARD)
- OPAL ACRYLIC DIFFUSER FOR SMOOTH LIGHT DISTRIBUTION



MODEL NO	WATT	DIMENSION (MM.)				
		L1	L2	W1	W2	H
F-RS-SLIM120/P	1 X T8 LED	1265	1245	100	85	100
F-RS-SLIM220/P	2 X T8 LED	1265	1245	150	130	100

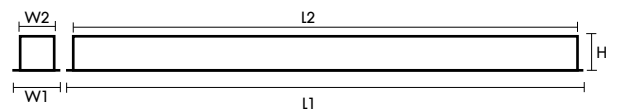



F-HL-SLIM/L

Pendant Louver Luminaire

HOUSING

- MADE OF HIGH QUALITY COLD-ROLLED STEEL SHEET OF THICKNESS 0.6 (T6)
- FIVE-STAGE ZINC PHOSPHATE PRETREATMENT FOR RUST RESISTANCE.
- FINISHED WITH POLYESTER POWDER BY TWO-STAGE ELECTROSTATIC METHOD.
- HEAVY DUTY ROTARY-LOCKED TYPE (TIS.344-1987 STANDARD)
- 99.85%(87) HIGH PURITY ANODIZED ALUMINIUM REFLECTOR WITH TOTAL REFLECTANCE OF 87%(87) FOR NORMAL USAGE.
- SPRING-LOCK TYPE LOUVER FOR EASE OF MAINTENANCE

MODEL NO	WATT	DIMENSION (MM.)		
		L	W	H
F-HL-SLIM120/L	1 X T8 LED.	1225	100	100
F-HL-SLIM220/L	2 X T8 LED.	1225	150	100

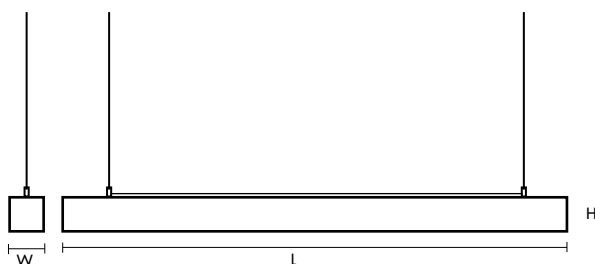

FLUORESCENT

F-XL-287-5S-228V

Slim Pendant Louver Luminaire

HOUSING

- MADE OF ALUMINIUM
- FINISHED WITH POLYESTER POWDER BY TWO -STAGE ELECTROSTATIC METHOD.
- HEAVY DUTY ROTARY-LOCKED TYPE (TIS.344-1987 STANDARD) (GS)
- 99.85% HIGH PURITY ANODIZED ALUMINIUM REFLECTOR WITH TOTAL REFLECTANCE OF 87% (87) FOR NORMAL USAGE.
- ALUMINIUM LOUVER
- INSTALLATION : PENDANT

MODEL NO	WATT	DIMENSION (MM.)		
		L	W	H
F-XL-287-5S-228V	2 X T5 28W	1200	255	60

สีเงินยาว 1 เมตร

**F-XL-901SH-228I-LED**

Slim Pendant Louver Luminaire

HOUSING

- Made Aluminium Die-Cast
- Finished with polyester powder by two -stage electrostatic method.
- Heavy duty rotary -locked type (TIS.344-1987 Standard) (GS)
- 99.85% high purity anodized aluminium reflector with Total Reflectance of 87% (87) for normal usage.
- Acrylic Diffuser
- Installation : Pendant

MODEL NO	WATT	DIMENSION (MM.)		
		L	W	H
F-XL-901SH-228I-LED	2 X T5 28W LEDx4 3W(3000K)	148	14	8



สีเงินยาว 1 เมตร



TRM-400/WH
Ø12 x H25
LED PAR30, E27
500.-



TRM-400/BK
Ø12 x H25
LED PAR30, E27
500.-



TRM-401/BK
Ø12 x H25
LED PAR30, E27
550.-

SPOTLIGHT

Adjustable Ceiling Spotlight

ALUMINIUM ANODIZED REFLECTOR



TRL-400/BK
Ø12 x H25
LED PAR30, E27
420.-



TRL-400/WH
Ø12 x H25
LED PAR30, E27
420.-



TRL-401
Ø12 x H25
LED PAR30, E27
500.-



TRACKLIGHT

Aadjustable Track light
ALUMINIUM ANODIZED REFLECTOR



TRL-1022/P30
Ø11.4 x H13.4
LED PAR30, E27
600.-



TRL-1031/P38
Ø13 x H14.5
LED PAR38, E27
650.-



TRL-E097/P30/BK
Ø11 x H12
LED PAR30/E27
600.-

TRACKLIGHT

Adujustable Track light
ALUMINIUM ANODIZED REFLECTOR



TRL-A014/WH
Ø9.3 x H12.5
กล่อง W5xL12xH14.7
CDM-TC/G8.5 (MAX 70W)
1,200.-
(ราคาไม่รวมบัลลาสต์)



TRL-A015/WH
Ø11.7 x H15.3
กล่อง W4.5xL12xH14.7
CDM-TD/G12 (MAX 70W)
1,200.-
(ราคาไม่รวมบัลลาสต์)

TRACKLIGHT

Adjustable Track light

ALUMINIUM ANODIZED REFLECTOR





TRM-201

Spot light

HOUSING : ALUMINIUM
PAINTING : BLACK AND WHITE

COMPATIBLE BULB	
	MR16 / GX5.3 50W

LED REPLACEMENT	
	LED-MR16 / GX5.3 5W

380.-

BK **WH** (INCLUDED TRANSFORMER)



TRL-201

Track light

HOUSING : ALUMINIUM
PAINTING : BLACK AND WHITE

COMPATIBLE BULB	
	MR16 / GX5.3 50W

LED REPLACEMENT	
	LED-MR16 / GX5.3 5W

380.-

BK **WH** (INCLUDED TRANSFORMER)



TRM-202

Spot light

HOUSING : ALUMINIUM
PAINTING : BLACK AND WHITE

COMPATIBLE BULB	
	MR16 / GX5.3 50W

LED REPLACEMENT	
	LED-MR16 / GX5.3 5W

380.-

BK **WH** (INCLUDED TRANSFORMER)



TRL-202

Track light

HOUSING : ALUMINIUM
PAINTING : BLACK AND WHITE

COMPATIBLE BULB	
	MR16 / GX5.3 50W

LED REPLACEMENT	
	LED-MR16 / GX5.3 5W

380.-

BK **WH** (INCLUDED TRANSFORMER)

TRM-202/ST

PAINTING : NICKLE SATIN.

580.-



TRL-202/ST

PAINTING : NICKLE SATIN.

580.-



TRM-203

Spot light

- HOUSING : ALUMINIUM
- PAINTING : BLACK AND WHITE

COMPATIBLE BULB	
	MR16 / GX5.3 50W

LED REPLACEMENT	
	LED-MR16 / GX5.3 5W

380.-

BK **WH** (INCLUDED TRANSFORMER)



TRL-203

Track light

HOUSING : ALUMINIUM
PAINTING : BLACK AND WHITE

COMPATIBLE BULB	
	MR16 / GX5.3 50W

LED REPLACEMENT	
	LED-MR16 / GX5.3 5W

380.-

BK **WH** (INCLUDED TRANSFORMER)



TRM-U30

Spot light

HOUSING : STEEL
PAINTING : WHITE, GREY AND BLACK

360.-



COMPATIBLE BULB	
	PAR30 / E27 100W

LED REPLACEMENT	
	LED-PAR30 / E27 15W



TRL-U30

Track light

HOUSING : STEEL
PAINTING : WHITE, GREY AND BLACK

360.-



COMPATIBLE BULB	
	PAR30 / E27 100W

LED REPLACEMENT	
	LED-PAR30 / E27 15W



TRM-U38

Spot light

HOUSING : STEEL
PAINTING : WHITE, GREY AND BLACK

380.-



COMPATIBLE BULB	
	PAR38 / E27 120W

LED REPLACEMENT	
	LED-PAR38 / E27 22W



TRL-U38

Track light

HOUSING : STEEL
PAINTING : WHITE, GREY AND BLACK

380.-



COMPATIBLE BULB	
	PAR38 / E27 120W

LED REPLACEMENT	
	LED-PAR38 / E27 22W



ราคารวมหัวจ่าย

TR-1M

300.-/1M

HOUSING : ALUMINIUM
PAINTING : BLACK OR WHITE

TR-2M

600.-/2M

TR-3M

1,000.-/3M



TR-A1

HOUSING : ABS
PAINTING : BLACK OR WHITE

100.-



หัวจ่าย

TR-A2

HOUSING : ABS
PAINTING : BLACK OR WHITE



100.-



TR-A3

HOUSING : ABS
PAINTING : BLACK OR WHITE



140.-



TRACKLIGHT

Adujustable Track light

ALUMINIUM ANODIZED REFLECTOR



LED TRACKLIGHT

OPL-SPOT18

OPL-SPOT28



OPL-TRL18/30 (18W)

OPL-TRL18/40 (18W)

OPL-TRL28/30 (28W)

OPL-TRL28/40 (28W)



Warm White
3000K

Cool Daylight
4000K

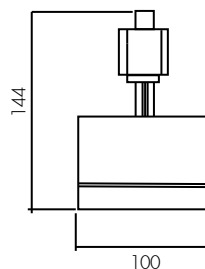



OPL-TRL5/30/WH (5W)
 OPL-TRL5/60/WH (5W)
 OPL-TRL7/30/WH (7W)
 OPL-TRL7/60/WH (7W)

OPL-TRL5/30/BK (5W)
 OPL-TRL5/60/BK (5W)
 OPL-TRL7/30/BK (7W)
 OPL-TRL7/60/BK (7W)

TRACKLIGHT

Adjustable Track light

ALUMINIUM ANODIZED REFLECTOR

Warm White 3000K Cool Daylight 6000K

คุณสมบัติ

- ใช้ Chip LED คุณภาพสูง กระจายแสงทั่วถึง ปราศจากจุดมืด
- เลนส์กระจายแสงที่ออกแบบมาพิเศษ
- โครงสร้างผลิตจากอลูมิเนียมเนื้อดี
- ระบายความร้อนได้ดี
- มีความยืดหยุ่น ปรับได้ทั้งแนวตั้งและแนวนอน
- อายุการใช้งาน 20,000 ชั่วโมง
- มีความยืดหยุ่น ช่วยเน้นสินค้าโชว์ตามมุมต่างๆ



ที่พักอาศัย ร้านค้าทั่วไป ห้างสรรพสินค้า โรงแรม ร้านอาหาร



OPL-TRM5/30/WH
 OPL-TRM5/60/WH
 OPL-TRM7/30/WH
 OPL-TRM7/60/WH
 OPL-TRM5/30/WH

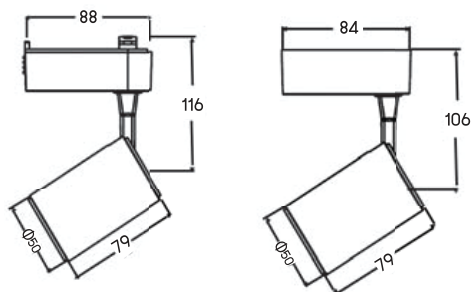



CEILING LAMP



CW-P-101
E27X2 (GENIE 18 W)
GLASS/STEEL
240-



CW-P-207
E27X2 (GENIE 18 W)
GLASS/STEEL
240.-



CW-P-099
E27X2 (GENIE 18 W)
GLASS/STEEL
240.-



CW-P-023
E27X2 (GENIE 18 W)
GLASS/STEEL
240-



CW-P-088
E27X2 (GENIE 18 W)
GLASS/STEEL
240-



CW-P-036
E27X2 (GENIE 18 W)
GLASS/STEEL
240-



CW-P-032
E27X2 (GENIE 18 W)
GLASS/STEEL
240-



CW-P-048
E27X2 (GENIE 18 W)
GLASS/STEEL
240-



CW-P-201
E27X2 (GENIE 18 W)
GLASS/STEEL
240-

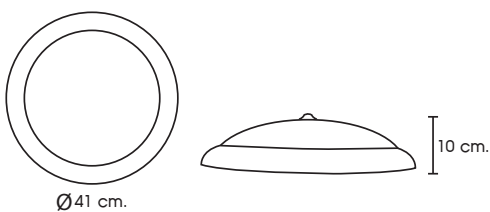

ใช้ร่วมกับอุปกรณ์ สำหรับ 32 วัตต์ หรือเปลี่ยนขั้ว E27 สำหรับใส่หลอดประหยัดไฟ

CEILING LAMP



CLG-5001/(32,40)
 /32 G10Q/32W, E27x2 (GENIE 18W) 300.-
 /40 G10Q/40W, E27x3 (GENIE 18W) 500.-



CLG-5002/(22,32,40)
 /22 E27 (GENIE 18) 200.-
 /32 G10Q/32W, E27x2 (GENIE 18W) 300.-
 /40 G10Q/40W, E27x3 (GENIE 18W) 500.-



CLG-5003/(22,32,40)
 /22 E27 (GENIE 18) 200.-
 /32 G10Q/32W, E27x2 (GENIE 18W) 300.-
 /40 G10Q/40W, E27x3 (GENIE 18W) 500.-



CLG-5004/(22,32,40)
 /22 E27 (GENIE 18) 200.-
 /32 G10Q/32W, E27x2 (GENIE 18W) 300.-
 /40 G10Q/40W, E27x3 (GENIE 18W) 500.-



CLG-5005/(22,32,40)
 /22 E27 (GENIE 18) 200.-
 /32 G10Q/32W, E27x2 (GENIE 18W) 300.-
 /40 G10Q/40W, E27x3 (GENIE 18W) 500.-



CLG-5006/(22,32,40)
 /22 E27 (GENIE 18) 200.-
 /32 G10Q/32W, E27x2 (GENIE 18W) 300.-
 /40 G10Q/40W, E27x3 (GENIE 18W) 500.-

/22 Ø30 cm.
 /32 Ø40 cm.
 /40 Ø65 cm.

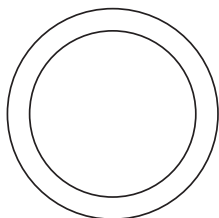

/22 >12 cm.
 /32 >13 cm.
 /40 >16 cm.



CEILING LAMP

ใช้ร่วมกับอุปกรณ์สำหรับ 32 วัตต์หรือเปลี่ยนขั้ว E27 สำหรับใส่หลอดประหยัดไฟได้

CEILING LAMP



C-F01/32

E27X2

ACYLIC COVER/STEEL PLATE/WOOD

W48 x L48 x H9

1,200.-

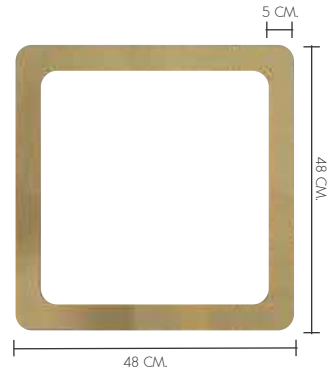
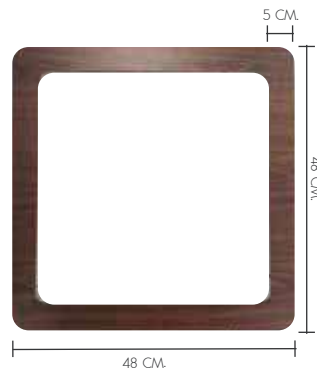

ลายไม้โอ๊ค

ลายโมธรรมชาติ

ขอบไม้จริงลาย 2 ด้าน สลับได้ เพื่อให้เข้ากับการตกแต่ง

ใช้ร่วมกับอุปกรณ์ LED 16 W - 24 W หรือเปลี่ยนขั้ว LED สำหรับใส่หลอดประหยัดไฟได้

CEILING LAMP



C-ME00/32
E27X2 (LED 16 W)
ACYLIC/STEEL
Ø35 x H10
360.-



C-ME01/32
E27X2 (LED 16 W)
ACYLIC/STEEL
Ø35 x H10
360.-



C-ME05/32
E27X2 (LED 16 W)
ACYLIC/STEEL
Ø35 x H10
360.-



C-ME00/22
E27X1 (LED 16 W)
ACYLIC/STEEL
Ø29 x H8
300.-



C-ME01/22
E27X1 (LED 16 W)
ACYLIC/STEEL
Ø30 x H8
300.-



C-ME05/22
E27X1 (LED 16 W)
ACYLIC/STEEL
Ø29 x H8
300.-



C-803
E27X2 (LED 18 W)
GLASS/STEEL
Ø32 x H11.5
600.-



C-ME09/D380
E27X1 (GENIE 18 W)
ACYLIC/STEEL
Ø40 x H10
360.-



C-S811
E27X2 (GENIE 18 W)
GLASS/STEEL
Ø43 x H10
500.-

CEILING LAMP



C-A200
E27X2 (LED 16 W)
ACYLIC/STEEL
Ø40 x H10
420.-



C-A300
E27X2 (GENIE 18 W)
ACYLIC/STEEL
Ø37 x H10
420.-

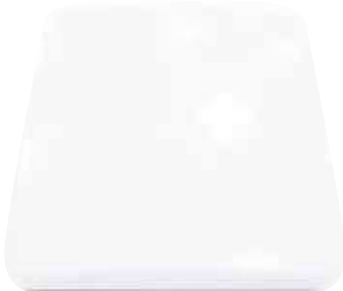

C-A400
E27X2 (GENIE 18 W)
ACYLIC/STEEL
Ø36 x H10
420.-



F-LR32
E27X1 (LED 16 W)
ACYLIC/STEEL
Ø38.2 x H7
700.-



ใช้กับ
LED Model 16W
3000K, 6000K
200.-

CEILING LAMP



C-2007A/13
E27X2 (GENIE 14 W)
GLASS/STEEL
Ø34 x H12
600.-



C-2007A/11
E27X2 (GENIE 11 W)
GLASS/STEEL
Ø28 x H12
500.-



C-2007B/13
E27X2 (GENIE 14 W)
GLASS/STEEL
Ø34 x H12
600.-



C-2007B/11
E27X2 (GENIE 11 W)
GLASS/STEEL
Ø28 x H12
500.-

CEILING LAMP



C-802
E27X2 (LED 16 W)
GLASS/STEEL
Ø29.5 x H9
500.-



C-2004
E27X2 (LED 16 W)
GLASS/STEEL
Ø29 x H7.5
500.-



C-028
E27X2 (LED 16 W)
GLASS/STEEL
Ø28 x H7
480.-



C-015-10
E27X2 (LED 7 W)
GLASS/STEEL
Ø23 x H7
400.-



C-1001
E27X2 (LED 7 W)
GLASS/STEEL
Ø23 x H8
400.-



C-106
E27X2 (LED 7 W)
GLASS/STEEL
Ø25 x H9
300.-



C-107
E27X1 (LED 7 W)
GLASS/STEEL
Ø20 x H10
220.-



C-8117/S
E27X1 (LED 7 W)
GLASS/STEEL
Ø20 x H10
240.-



C-8117/L
E27X2 (LED 7 W)
GLASS/STEEL
Ø25 x H10.5
300.-

Central Unit

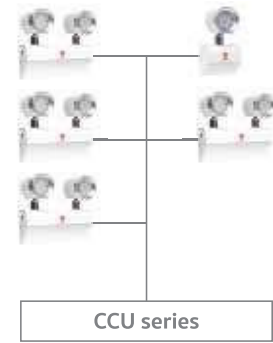

Figure C

Figure B

Figure A

Diagram



CCU 12V Series for Remote Lamp 12V

Model	Power (Wattage)	Battery Capacity	Back up Time (hrs.)	Dimension (mm.)			Weight (kgs.)	Figure
				L	W	H		
CCU 12-30	30	12V-7 Ah.	2	290	80	160	4.30	A
CCU 12-50	50	12V-12 Ah.		290	110	160	6.60	
CCU 12-60	60	12V-15 Ah.		340	100	220	8.40	
CCU 12-80	80	12V-18 Ah.		340	110	220	9.60	
CCU 12-110	110	12V-24 Ah.		340	160	235	13.20	
CCU 12-120	120	12V-26 Ah.		340	160	235	13.25	
CCU 12-180	180	12V-40 Ah.		400	200	250	19.20	
CCU 12-250	250	12V-26 Ah.x2	2	500	200	250	30.60	B
CCU 12-300	300	12V-65 Ah.		500	200	250	33.90	
CCU 12-350	350	12V-40 Ah.x4		500	250	300	42.00	
CCU 12-470	470	12V-100 Ah.		500	250	300	46.00	
CCU 12-550	550	12V-130 Ah.	2	620	350	750	74.00	C
CCU 12-620	620	12V-130 Ah.		620	350	750	76.00	
CCU 12-720	720	12V-150 Ah.		620	350	750	77.00	
CCU 12-850	850	12V-200 Ah.		620	350	750	99.50	
CCU 12-1000	1000	12V-200 Ah.		620	350	750	99.50	
CCU 12-1100	1100	12V-130 Ah.x2		620	400	950	119.00	
CCU 12-1400	1400	12V-150 Ah.x2		620	400	950	125.00	
CCU 12-1900	1900	12V-200 Ah.x2		620	400	950	171.80	

SN209NC2LED

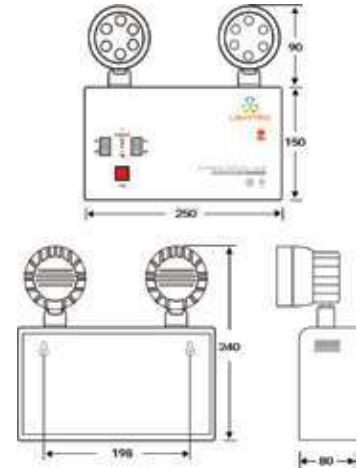

PRODUCT OVERVIEW

- โคมไฟแสงสว่างฉุกเฉิน รุ่น SN209NC2LED ใช้หลอดLED ที่มีคุณภาพ
- แสงสว่างสูงแต่ใช้พลังงานไฟฟ้ากำลึงวัตต์ต่ำ
- สามารถช่วยประหยัดพลังงานไฟฟ้่า
- การกระจายแสงของหลอดมีประสิทธิภาพ มากกว่าหลอดฮาโลเจน 5 เท่า
- อายุการใช้งานยาวนานมากกว่า 50,000 ชั่วโมง
- โคมไฟสว่างฉุกเฉิน SN209NC2LED ทำงานโดยอัตโนมัติ
- มีระบบการประจุไฟฟ้่าที่ช่วยยืดอายุ
- ตัวถังทำจากเหล็กแผ่นป็นและพับขึ้นรูป พ่นกันสนิม
- เคลือบด้วยสีฝุ่นและอบด้วยความร้อน

FEATURES

- ใช้หลอด LED กำลังสูง พิกัด 9 วัตต์ จำนวน 2 หัวโคม ในการให้แสงสว่าง
- มีอายุการใช้งานที่ยาวนานกว่า 50,000 ชั่วโมง
- ให้แสงคงที่ยาวนานกว่า 2 ชั่งโมง
- ประจุแบตเตอรี่แบบอัตโนมัติ โดยการควบคุมแรงดันและกระแสไฟฟ้่า CONSTANT VOLTAGE&LIMIT CURRENT
- ได้รับมาตรฐานอุตสาหกรรม มอก.1102-2538 ,มอก.1995-2551
- รับประกันแผงวงจรหลัก 5 ปี และแบตเตอรี่ 18 เดือน

INDICATORS

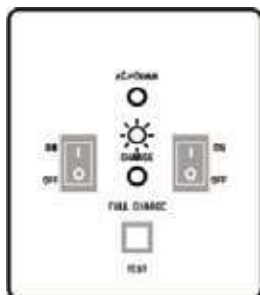

- LED AC POWER : หลอดไฟติดสว่างแสดงผลตัวเครื่องได้รับแรงดันไฟฟ้่า 220Vac.
- LED CHARGE : หลอดไฟติดสว่างแสดงผลตัวเครื่องกำลังชาร์จแบตเตอรี่
- LED FULL CHARGE : หลอดไฟดับแสดงผลตัวเครื่องชาร์จแบตเตอรี่เต็ม
- LED OVER CHARGE : หลอดไฟติดสว่างแสดงผลความผิดปกติของตัวเครื่อง ในส่วนของวงจรชาร์จแบตเตอรี่
- SWITCH TEST : สวิตช์ทดสอบความล้มเหลวของไฟ AC220V.
- SWITCH ON/OFF : สวิตช์ เปิด/ปิด หลอดไฟฉุกเฉินแยกอิสระ: ซ้าย, ขวา

SPECIFICATIONS

SPECIFICATIONS	
INPUT VOLTAGE	220V / 50Hz
LED LAMP POWER	9W / BULB
COLOR TEMPERATURE	5,500 - 6,500K
RATED BEAM ANGLE	36°
BATTERY TYPE/SIZE	SEALED LEAD-ACID 6V4Ah
BATTERY CUT-OFF VOLTAGE	1.60-1.75V / CELL
CHARGING MODE	CONSTANT VOLTAGE&LIMIT CURRENT
CHARGING CURRENT	450mA
CHARGING TIME	10-15HRS.
BACKUP TIME	2 HRS.
HOUSING	STEEL SHEET, 1MM, THICK WITH POWDER PAINT.
DIMENSION (LxHxW)	250 X 240 X 80 MM.
WEIGHT	2.63 KG.

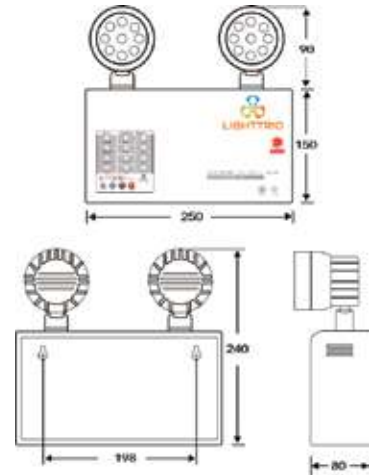

PRODUCT OVERVIEW

- โคมไฟไฟแสงสว่างฉุกเฉิน รุ่น MCU209NC2LED ใช้หลอดLED ที่มีคุณภาพ
- ประสิทธิภาพของแสงสว่างมากกว่าหลอดฮาโลเจน ขนาด 50 วัตต์
- หลอดมีอายุการใช้งานได้ยาวนานมากกว่า 50,000 ชั่วโมง
- ลดค่าใช้จ่ายของแบตเตอรี่ที่มีขนาดเล็กถึง 3 เท่า ตัวเครื่อง
- สามารถให้แสงสว่างคงที่และยาวนานกว่า 2 ชั่วโมง
- ควบคุมการทำงานโดย Microcontroller หน้าตัวเครื่องจะมีปุ่มสั่งงาน Function หลากหลาย
- ใช้ Remote Infrared Control แทนการกดปุ่มจากตัวเครื่องเพื่อเพิ่มความสะดวกในการใช้งาน

INDICATORS

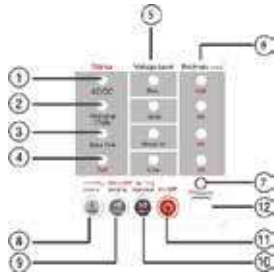

- LED AC/DC : แสดงสถานะตัวเครื่องใช้พลังงานไฟฟ้าทางดับไฟกระแสดับ AC220V
: LED จะสว่างค้าง , กรณีใช้พลังงานจากแบตเตอรี่ LED จะกระพริบ
- LED CHARGING/FULLY : แสดงสถานะการประจุแบตเตอรี่ แบตเตอรี่เต็ม LED สว่างค้าง , กำลังชาร์จ
: LED กระพริบ
- LED AUTO TEST : แสดงสถานะการทดสอบตัวเครื่องแบบอัตโนมัติ LED สว่างค้างเมื่อทำงาน
- LED FAIL : แสดงสถานะความผิดปกติของตัวเครื่อง เพื่อการตรวจสอบ
- LED VOLTAGE LEVEL : แสดงระดับของแรงดันแบตเตอรี่
- LED BACK-UP : แสดงช่วงระยะเวลาของการทดสอบแบบอัตโนมัติหรือการทดสอบการผู้ใช้
: ผ่านตัวเครื่องและรีโมท
- LED IR RECEIVER : แสดงสถานะตัวเครื่องได้รับคลื่นอินฟราเรดจากรีโมททาส่งโดย LED สว่าง
- SWITCH NORMAL : สวิตช์ทดสอบการทำงานของตัวเครื่อง ภายประจุแบตเตอรี่ 5 วินาที
- SWITCH MONTHLY : สวิตช์ทดสอบการทำงานของตัวเครื่อง ภายประจุแบตเตอรี่ 30 วินาที
- SWITCH HALF YEAR : สวิตช์ทดสอบการทำงานของตัวเครื่อง ภายประจุแบตเตอรี่ 60 วินาที
- SWITCH ON/OFF : สวิตช์เปิด/ปิดหลอดไฟ หรือ ยกเลิกคำสั่งการทดสอบในฟังก์ชันต่างๆ
- IR RECEIVER : ช่องรับสัญญาณคลื่นอินฟราเรด จากรีโมททาส่ง
- SAFETY SWITCH : สวิตช์แมนูเอาเวอร์ เปิด/ปิด ระบบการทำงานของตัวเครื่องทั้งหมด

FEATURES

- ใช้หลอด LED กำลังสูง พิกัด 9 วัตต์ จำนวน 2 หัวโคม ในการให้แสงสว่าง
- มีอายุการใช้งานที่ยาวนานกว่า 50,000 ชั่วโมง
- ให้แสงสว่างมากกว่าหลอดฮาโลเจน ขนาด 50W x 2
- ให้แสงคงที่ยาวนานกว่า 2 ชั่วโมง
- สามารถทดสอบการทำงานได้ด้วยรีโมทคอลลีท
- มีฟังก์ชันการทดสอบการทำงานอัตโนมัติ (Auto Test) ประจำ 1 เดือน ทุกๆ วันที่ 1 เวลา 12.00-12.30น. ประจำ 6 เดือน ทุกๆ วันที่ 15 เวลา 12.00-13.00น.
- ได้รับมาตรฐานอุตสาหกรรม มอก.1102-2538 ,มอก.1995-2551
- รับประกันแผงวงจรหลัก 5 ปี และแบตเตอรี่ 2 ปี

SPECIFICATIONS

INPUT VOLTAGE	220V / 50Hz
LED LAMP POWER	9W / BULB
COLOR TEMPERATURE	2,700 = 3,000K (WARM WHITE) 5,500 = 6,500K (COOL WHITE)
RATED BEAM ANGLE	36°
BATTERY TYPE/SIZE	SEALED LEAD-ACID 12V2.9Ah
BATTERY CUT-OFF VOLTAGE	1.60-1.75V / CELL
CHARGING MODE	CONSTANT VOLTAGE&LIMIT CURRENT
CHARGING CURRENT	290mA
CHARGING TIME	10-15HRS.
BACKUP TIME	2 HRS.
HOUSING	STEEL SHEET, 1MM. THICK COATED WITH POWDER PAINT.
DIMENSION (LxHxW)	250 X 240 X 80 MM.
WEIGHT	4 KG.

SLS1-10LED/D-RT (DOUBLE-SIDE)



SPECIFICATIONS

INPUT VOLTAGE	220V / 50Hz
INPUT CURRENT (MAX)	0.056A@220VAC
INPUT POWER (MAX)	11.20W
INPUT POWER (STANDBY)	7.04W
LED COLOR TEMPERATURE	6,500K
LAMP CURRENT (AC)	0.670A
LAMP CURRENT (BATTERY)	0.650A@1.2V/CELL
BATTERY	NiMH 1,800mAh(1.2Vx3)
CHARGE CURRENT (MAX)	0.180A
CHARGE TERMINATING VOLTAGE	1.4V/CELL
CHAGING TIME	12 HRS.
BATTERY LOW VOLTAGE CUT-OFF	1.0V/CELL
BACKUP TIME	2 HRS.
DIMENSION	400 x 200 x 60MM.
WEIGHT	1,4 KG.

PRODUCT OVERVIEW

- ป้ายไฟทางออกฉุกเฉิน รุ่น SLS1-10LED/S
- ลักษณะการใช้ติดตั้ง การติดตั้งแบบผนังและเพดาน
- หลอดไฟที่ใช้เป็นหลอด LED มีประสิทธิภาพสูง
- ประหยัดพลังงานได้มากกว่าระบบเดิมที่ใช้หลอดฟลูออเรสเซนต์ถึง 6 เท่า
- มีอายุการใช้งานที่ยาวนานกว่าถึง 7 เท่า
- ใช้แบตเตอรี่ชนิด NI-MH (NIKLE METAL HYDRIDE) ที่มีขนาดเล็ก
- แบตเตอรี่ SEALED LEAD ACIC แบตเตอรี่ 2-3 เท่า
- สามารถสำรองไฟได้นานถึง 2 ชั่วโมง
- ใช้แผ่นอะคริลิกโปร่งแสงชนิด ESD ที่มีคุณสมบัติพิเศษโดยทำให้ลำแสงของหลอดไฟกระจายทั่วทั้งแผ่นอย่างสม่ำเสมอและการกระจายแสงมีความคงทนและยาวนาน
- ตัวกล่องทำจากเหล็กคุณภาพ ปีนและพับขึ้นรูป เคลือบกันสนิม แผ่นด้วยสีฝุ่นคุณภาพสูงและอบด้วยความร้อน

FEATURES

- ใช้หลอด LED กำลังสูง พิกัด 10 วัตต์ ในการให้แสงสว่าง
- มีอายุการใช้งานที่ยาวนานกว่า 50,000 ชั่วโมง
- ให้แสงคงที่ยาวนานกว่า 2 ชั่วโมง
- ประจุแบตเตอรี่แบบอัตโนมัติ โดยการควบคุมแรงดันและกระแสไฟฟ้า CONSTANT VOLTAGE&LIMIT CURRENT
- รองรับการทดสอบการทำงานได้ด้วยรีโมทคอนโทรล (ออฟชั่น)
- ใต้มาตรฐานอุตสาหกรรม มอก.1102-2538 ,มอก.1995-2551
- รับประกันแผงวงจรหลัก 5 ปี และแบตเตอรี่ 3 ปี

INSTALLATION

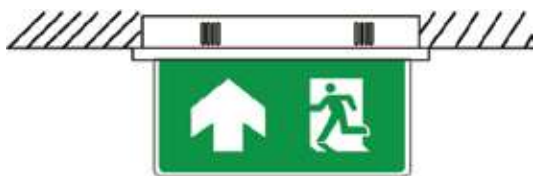

Ceiling Recessed

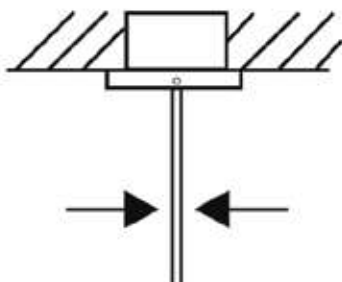

DIMENSION (MM)

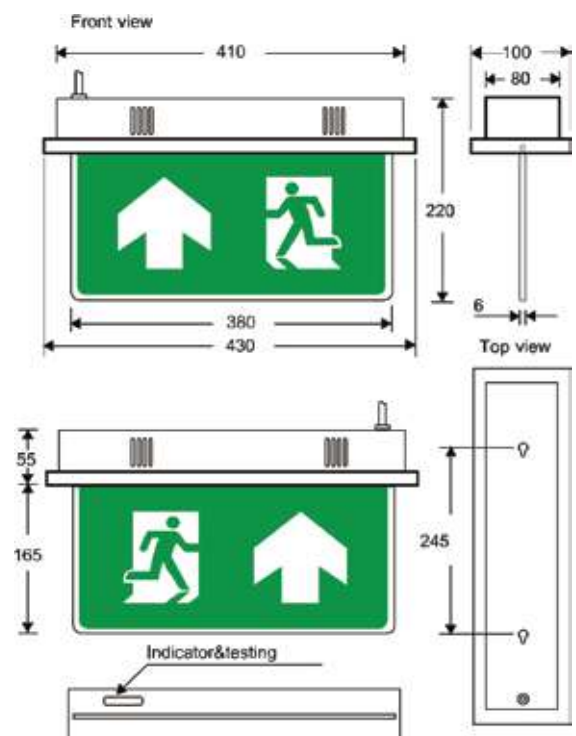

SLS1-10LED/S-RT (SINGLE-SIDE)



SPECIFICATIONS

INPUT VOLTAGE	220V / 50Hz
INPUT CURRENT (MAX)	0.056A@220VAC
INPUT POWER (MAX)	11.20W
INPUT POWER (STANDBY)	7.04W
LED COLOR TEMPERATURE	6,500K
LAMP CURRENT (AC)	0.670A
LAMP CURRENT (BATTERY)	0.650A@1.2V/CELL
BATTERY	NiMH 1,800mAh(1.2Vx3)
CHARGE CURRENT (MAX)	0.180A
CHARGE TERMINATING VOLTAGE	1.4V/CELL
CHAGING TIME	12 HRS.
BATTERY LOW VOLTAGE CUT-OFF	1.0V/CELL
BACKUP TIME	2 HRS.
DIMENSION	430 x 220 x 100MM.
WEIGHT	1.78 KG.

PRODUCT OVERVIEW

- บั้ยไฟทางออกฉุกเฉิน รุ่น SLS1-10LED/D
- สามารถติดตั้งแบบผนังและเพดาน
- หลอดไฟที่ใช้เป็นหลอด LED มีประสิทธิภาพสูง
- ประหยัดพลังงานได้มากกว่าระบบเดิมที่ใช้หลอดฟลูออโรสเซนต์ถึง 6 เท่า
- มีอายุการใช้งานที่ยาวนานกว่าถึง 7 เท่า
- ใช้แบตเตอรี่ชนิด NI-MH (NIKLE METAL HYDRIDE) ที่มีขนาดเล็ก
- แบตเตอรี่ SEALED LEAD ACIC แบตเตอรี่ 2-3 เท่า
- สามารถสำรองไฟได้นานถึง 2 ชั่วโมง
- ใช้แผ่นอะคริลิกโปร่งแสงชนิด ESD ที่มีคุณสมบัติพิเศษช่วยลดการกระเจิงแสงของหลอดไฟกระจายทั่วทั้งแผ่นอย่างสม่ำเสมอและการกระจายแสงมีความคงทนและยาวนาน
- ตัวกล่องทำจากเหล็กคุณภาพ เบียวและพับขึ้นรูป เคลือบกันสนิม พื้นด้วยสีฝุ่นคุณภาพสูงและอบด้วยความร้อน

FEATURES

- ใช้หลอด LED กำลังสูง พิกัด 10 วัตต์ ในการให้แสงสว่าง
- มีอายุการใช้งานที่ยาวนานกว่า 50,000 ชั่วโมง
- ให้แสงคงที่ยาวนานกว่า 2 ชั่วโมง
- ประจุแบตเตอรี่แบบอัตโนมัติ โดยการควบคุมแรงดันและกระแสไฟฟ้า CONSTANT VOLTAGE&LIMIT CURRENT
- รองรับการทดสอบการทำงานได้ด้วยวิธีโมคโคลโทรส (ออฟชั่น)
- ได้รับมาตรฐานอุตสาหกรรม มอก.1102-2538 ,มอก.1995-2551
- รับประกันแผงวงจรหลัก 5 ปี และแบตเตอรี่ 3 ปี

INSTALLATION

Ceiling Type



Wall Type



DIMENSION (MM)

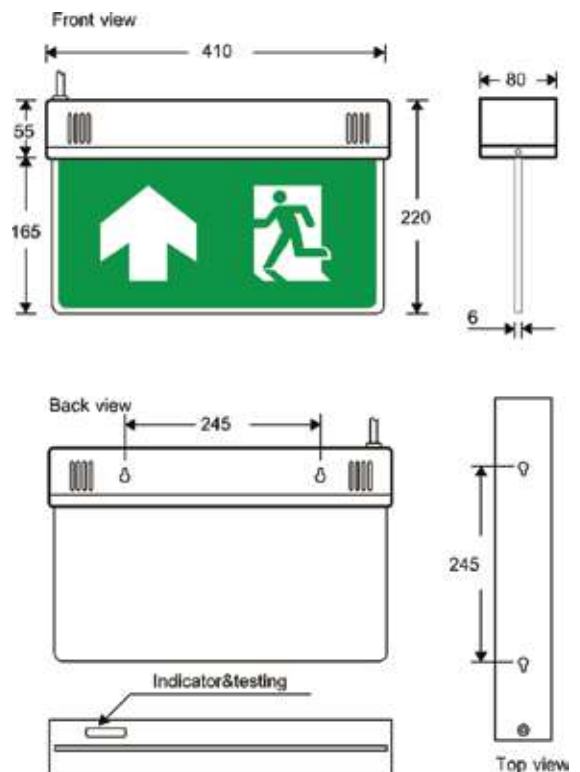

EXS1-10LED/S-RT (SINGLE-SIDE)



SPECIFICATIONS

INPUT VOLTAGE	220V / 50Hz
INPUT CURRENT (MAX)	0.056A@220VAC
INPUT POWER (MAX)	11.20W
INPUT POWER (STANDBY)	7.04W
LED COLOR TEMPERATURE	6,500K
LAMP CURRENT (AC)	0.670A
LAMP CURRENT (BATTERY)	0.650A@1.2V/CELL
BATTERY	NiMH 1,800mAh(1.2Vx3)
CHARGE CURRENT (MAX)	0.180A
CHARGE TERMINATING VOLTAGE	1.4V/CELL
CHAGING TIME	12 HRS.
BATTERY LOW VOLTAGE CUT-OFF	1.0V/CELL
BACKUP TIME	2 HRS.
DIMENSION	400 x 200 x 60MM.
WEIGHT	1.6 KG.

PRODUCT OVERVIEW

- ป้ายไฟทางออกฉุกเฉิน รุ่น EXS1-10LED/S
- สามารถติดตั้งแบบผนังและเพดาน
- หลอดไฟที่ใช้เป็นหลอด LED มีประสิทธิภาพสูง
- ประหยัดพลังงานได้มากกว่าระบบเดิมที่ใช้หลอดฟลูออโรสเซนต์ถึง 6 เท่า
- มีอายุการใช้งานที่ยาวนานกว่าถึง 7 เท่า
- ใช้แบตเตอรี่ชนิด NI-MH (NIKLE METAL HYDRIDE) ที่มีขนาดเล็ก
- แบตเตอรี่ SEALED LEAD ACID แบตเตอรี่ 2-3 เท่า
- สามารถสำรองไฟได้นานถึง 2 ชั่วโมง
- ใช้แผ่นอะคริลิกโปร่งใสที่มีคุณสมบัติพิเศษโดยทำให้แสงของหลอดไฟกระจายทั่วทั้งแผ่นอย่างสม่ำเสมอและการกระจายแสงมีความคงทนและยาวนาน
- ตัวกล่องทำจากเหล็กคุณภาพเยี่ยมและปรับขึ้นรูป เคลือบกันสนิม พื้นด้วยสีฝุ่นคุณภาพสูงและอบด้วยความร้อน

FEATURES

- ใช้หลอด LED กำลังสูง พิกัด 10 วัตต์ ในการให้แสงสว่าง
- มีอายุการใช้งานที่ยาวนานกว่า 50,000 ชั่วโมง
- ให้แสงสว่างที่ยาวนานกว่า 2 ชั่วโมง
- ประจุแบตเตอรี่แบบอัตโนมัติ โดยการควบคุมแรงดันและกระแสไฟฟ้า CONSTANT VOLTAGE&LIMIT CURRENT
- รองรับการทดสอบการทำงานได้ด้วยรีโมทคอนโทรล (ออฟชั่น)
- ใต้มาตรฐานอุตสาหกรรม มอก.1102-2538 ,มอก.1995-2551
- รับประกันแผงวงจรหลัก 5 ปี และแบตเตอรี่ 3 ปี

INSTALLATION

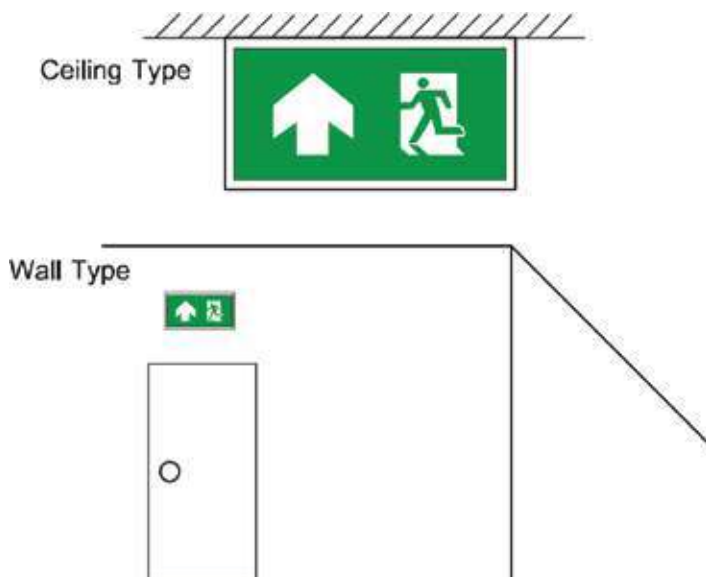

DIMENSION (MM)

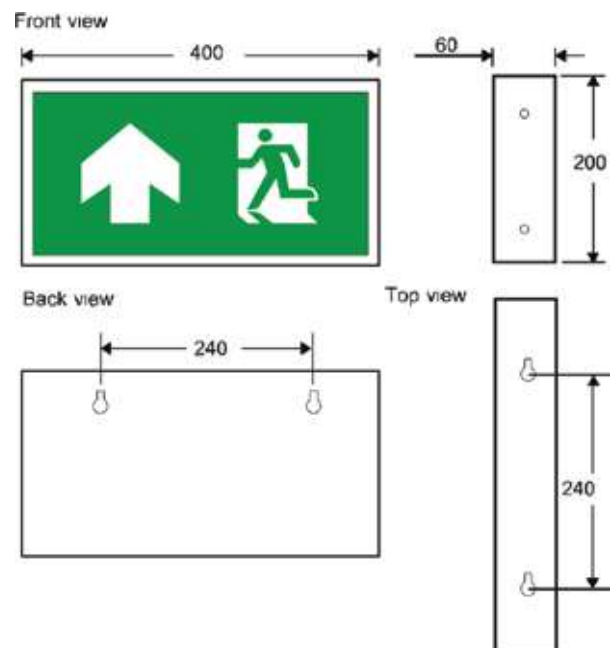

EXS1-10LED/D-RT (DOUBLE-SIDE)



SPECIFICATIONS

INPUT VOLTAGE	220V / 50Hz
INPUT CURRENT (MAX)	0.056A@220VAC
INPUT POWER (MAX)	11.20W
INPUT POWER (STANDBY)	7.04W
LED COLOR TEMPERATURE	6,500K
LAMP CURRENT (AC)	0.670A
LAMP CURRENT (BATTERY)	0.650A@1.2V/CELL
BATTERY	NiMH 1,800mAh(1.2Vx3)
CHARGE CURRENT (MAX)	0.180A
CHARGE TERMINATING VOLTAGE	1.4V/CELL
CHAGING TIME	12 HRS.
BATTERY LOW VOLTAGE CUT-OFF	1.0V/CELL
BACKUP TIME	2 HRS.
DIMENSION	400 x 200 x 60MM.
WEIGHT	1,4 KG.

PRODUCT OVERVIEW

- ป้ายไฟทางออกฉุกเฉิน รุ่น EXS1-10LED/S
- สามารถติดตั้งแบบผนังและเพดาน
- หลอดไฟที่ใช้เป็นหลอด LED มีประสิทธิภาพสูง
- ประหยัดพลังงานได้มากกว่าระบบเดิมที่ใช้หลอดฟลูออโรสเซนต์ถึง 6 เท่า
- มีอายุการใช้งานที่ยาวนานกว่าถึง 7 เท่า
- ใช้แบตเตอรี่ชนิด NI-MH (NICKEL METAL HYDRIDE) ที่มีขนาดเล็ก
- แบตเตอรี่ SEALED LEAD ACID แบตเตอรี่ 2-3 เท่า
- สามารถสำรองไฟได้นานถึง 2 ชั่วโมง
- ใช้แผ่นอะคริลิกโปร่งใสที่มีคุณสมบัติพิเศษโดยทำให้ลำแสงของหลอดไฟกระจายทั่วทั้งแผ่นอย่างสม่ำเสมอและการกระจายแสงมีความคงทนและยาวนาน
- ตัวกล่องทำจากเหล็กคุณภาพ เบาและพับขึ้นรูป เคลือบกันสนิม พ่นด้วยสีฝุ่นคุณภาพสูงและอบด้วยความร้อน

FEATURES

- ใช้หลอด LED กำลังสูง พิกัด 10 วัตต์ ในการให้แสงสว่าง
- มีอายุการใช้งานที่ยาวนานกว่า 50,000 ชั่วโมง
- ให้แสงสว่างที่ยาวนานกว่า 2 ชั่วโมง
- ประจุแบตเตอรี่แบบอัตโนมัติ โดยการควบคุมแรงดันและกระแสไฟฟ้า CONSTANT VOLTAGE&LIMIT CURRENT
- รองรับการผลิตสอบการทำงานได้ด้วยรีโมทคอนโทรล (ออฟชั่น)
- ได้รับมาตรฐานอุตสาหกรรม มอก.1102-2538 ,มอก.1995-2551
- รับประกันแพคเกจจอร์หลัก 5 ปี และแบตเตอรี่ 3 ปี

INSTALLATION

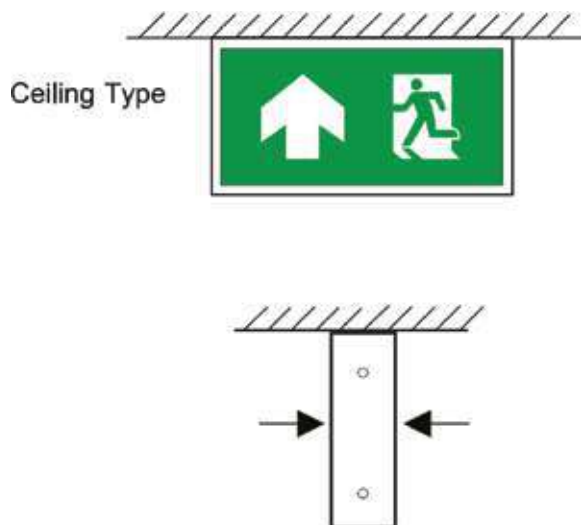

DIMENSION (MM)

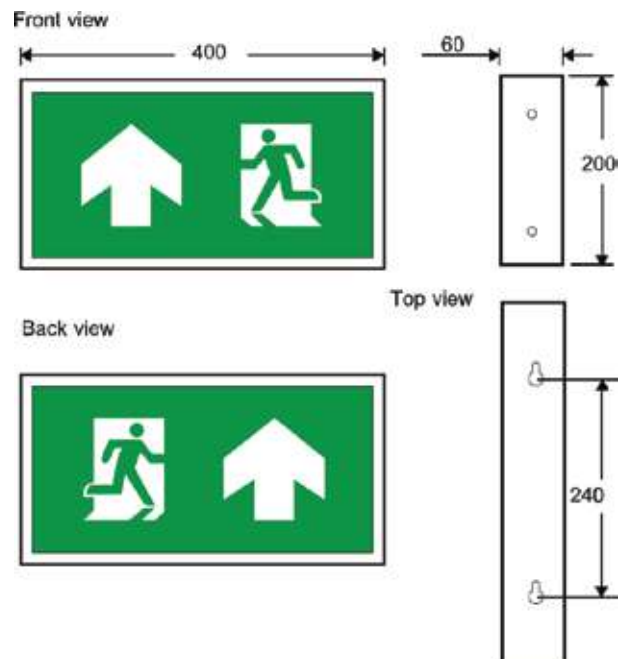

EMERGENCY
STANDARD SYMBOL LIGHT



EF-001



EF-002



EF-003



EF-004



EF-005



EF-006



EF-007



EF-008



EF-009



EF-010



EF-011



EF-012



EF-013



EF-014



EF-015



EF-016



EF-017



EF-018



EF-019



EF-020



EF-021



EF-022



EF-023



EF-024



EF-025



EF-026



EF-027



EF-028

DECORATIVE LAMP



Ceiling & Hanging

เราคัดสรรโคมไฟ ตกแต่งบ้านและคอนโดอย่างครบวงจร ทุกสไตล์ เพื่อคุณและคนที่คุณรัก..แต่งบ้านคุณให้สวยเหมือนโรงแรมหรู



HL-BELLA 2,000.-



HL-ZOEY 1,700.-



HL-PAZ 2,100.-



HL-ATOM/BK 2,300.-



HL-REX/WH 2,800.-



HL-MONIX/WH 1,600.-



HL-MONIX/BK 1,600.-



HL-DOOZY/BK 2,500.-



HL-DOOZY/PG 3,900.-



HL-KENTY/WH 1,600.-



HL-MUZZLE/BK 850.-



HL-MUZZLE/PG 1,000.-



HL-MIFFI/PG 1,400.-



HL-ATMOS/BK 1,600.-





HL-ARIS-39/BK 1,300.-



HL-PEAR/PG 900.-



HL-PEAR/BK 700.-



HL-HOLD/AB 700.-



HL-DIAMOND-38/BK 2,000.-



HL-DIAMOND-50/BK 3,000.-



HL-DIAMOND-68/BK 7,000.-



HL-ALFA/BK 1,000.-



HL-ALFA/WH 1,000.-



HL-BETA/BK 1,000.-



HL-BETA/WH 1,000.-



HL-CELTA/BK 1,000.-



HL-CELTA/WH 1,000.-



HL-TOMSON/BK-36 1,400.-



HL-TOMSON/BK-46 2,200.-





HL-SEMI50/CR 10,000.-



HL-SEMI50/BK 9,000.-



HL-COLUME/WH 5,000.-



HL-COLUME/BK 5,000.-



HL-HUD/RD 9,700.-



HL-BOSTON/A 3,200.-



HL-BOSTON/B/BK 1,200.-



HL-PIXX/PG 1,300.-



HL-CAPSULE/PG 1,000.-



HL-GUS/PG 1,300.-



HL-UTAH 1,200.-



HL-SEMI30/CR 2,500.-



HL-SEMI30/BK 3,000.-



HL-ETHAN/PG 1,900.-





HL-150/H1 2,000.-



HL-329/BL 1,200.-



HL-329/RD 1,200.-



HL-329/WH 1,200.-



HL-329/YW 1,200.-



HL-0106/BL 900.-



HL-0106/GN 900.-



HL-87489-FARGO 2,000.-



HL-3004/H1/BW 1,000.-



HL-3004/H1/YW 1,000.-



HL-3004/H1/GN 1,000.-



HL-3004/H1/WH 1,000.-



HL-3004/H1/OR 1,000.-



HL-3004/H1/RD 1,000.-



HL-83202-TROY 1,000.-



HL-1200-230 1,000.-



HL-711 900.-



HL-713 900.-



HL-1995/H1 2,000.-



HL-3054/H1 1,600.-





HL-MUZZLE-3/BK 2,500.-



HL-MUZZLE-3/PG 3,000.-



HL-BOSTON/3/B 8,500.-



HL-TRIZY 2,500.-



HL-BOSTON/3/A 9,000.-



HL-G0944/H3 1,800.-



Ceiling & Hanging



HL-83203-TROY1 2,800.-



HL-806/H3 2,000.-



HL-537/H3 2,000.-



HL-8253/H3 2,500.-



HL-1210/H3 3,200.-





HL-1220/H3 2,400.-



HL-1954/H3 3,000.-



HL-002/H3 1,500.-



HL-064/3/MP3 4,000.-



HL-120/H3 1,900.-



CR-MICHELL/16-85 28,000.-



HL-RINGKO/30/WWH-100 9,000.-



CH-QH-01/8 8,000.-



HL-4222/H3 2,000.-



HL-BM09/H3 2,200.-



HL-112/H3 2,500.-



HL-5567/H3 2,000.-

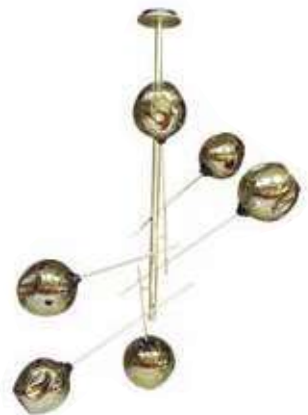

HL-CASPER/6/GL 15,000.-





HL-INSPIRE/10/GD 14,000.-



HL-BRANCH/6 6,000.-



Wall Light

เสน่ห์จากแสงไฟ สร้างสรรค์บรรยากาศบ้านสวย มีชีวิตชีวา กับ
 มนต์เสน่ห์แสงไฟดวงเล็กที่ไม่ธรรมดา สิ่งที่สะท้อนความเป็นตัวตน
 หรือรสนิยมของความสุขในการใช้ชีวิต



WI-KRAM3 2,800.-



WI-KRAM2 2,500.-



WI-HOOK/A/BK 1,400.-



WI-HOOK/B/BK 1,600.-



WI-TOMSON/BK-36 1,400.-



WI-BOSTON/B/BK 1,200.-



WI-UTAH 1,200.-



WI-88193-PALERMO 1,500.-



WI-0020/1 500.-



WI-90647-FORTUNA 1,200.-





WI-198658 1,100.-



WI-179441 900.-



WI-6107 450.-



WI-6188 450.-



WI-602 600.-



WI-87221-PALMERA 1,300.-



WI-88563-HALVA 2,400.-



WI-89456-SANTANEDR 2,400.-



WI-90925-HALVA 3,000.-



WI-89816-ZEPTO 1,800.-



WI-91342-SANIA 1,000.-



WI-87219-PALMERA 1,600.-



WI-MBO185/1 940.-



WI-MBO184/1 940.-



WI-STELLA 900.-



WI-82218-EOS 2,000.-



WI-1814-G9/BK 900.-



WI-1814-G9/SL 900.-





WI-83891-SINTAR 1,400.-



WI-0201 1,400.-



WI-CHILLI 840.-

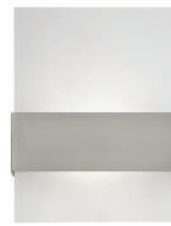

WM-87139-CUBIK 2,400.-



WI-82219-EOS 2,050.-



WI-8067/2 1,700.-



WI-8037 900.-



WI-8061 1,200.-



WI-WL6-15/WH 1,400.-



WI-86996-NIKITA 1,200.-



WI-85338-MONO 1,000.-



WI-83405-ZOLA 2,150.-



WI-83406-ZOLA 1,500.-



WI-83407-ZOLA 950.-



WI-1866-T5-14 2,000.-





WI-APRIL 900.-



WI-TUBE30 1,200.-



WI-SWAN 900.-



WM-86541-BEVERLY 2,300.-



WI-AUGUST 1,200.-



WI-87019-MADRAS 1,200.-



WI-87018-MADRAS 1,000.-



WI-MIRROR 1,200.-



WI-KRAM7/WH 4,000.-



WI-9054 800.-



WI-9053 800.-



WI-91048/2 1,200.-



WI-579 960.-



WI-B-059 1,500.-



WI-975/1 600.-



WI-248/2 800.-



WI-573 800.-





WI-B-022 1,500.-



WI-B-032 1,500.-



WI-B-033 1,500.-



WI-220/1 800.-



WI-566 1,400.-



WI-3013/BL 1,000.-



WI-3013/RD 1,000.-



WI-62122 600.-



WI-62128 600.-



WI-62133 600.-



WI-634/OR 900.-



WI-634/YW 900.-



WI-814 900.-



WI-IN-B819RD+GN+YW 700.-



WI-IN-B819RD+YW+BK 700.-



WI-20064/2 800.-



WI-20087/1 600.-



WI-20087/2 800.-



WI-2037/1 600.-





CR-MILLER/12-65 30,000.-



Crystal Light

แสงไฟเพื่อบรรยากาศของบ้านสวย นอกเหนือจากความสำคัญ
ในเรื่องประโยชน์ใช้สอยแล้ว แสงไฟยังเป็นองค์ประกอบหนึ่งของการ
ตกแต่ง รูปแบบและดีไซน์ของไฟชนิดต่างๆ สร้างเสน่ห์ให้กับบ้าน



CR-2037/6 3,200.-



CR-20087/6+1 2,800.-



CR-8006/5 10,000.-



CR-8186/6 7,000.-



CR-2028/6 6,400.-



CR-2036/8+4 10,000.-



CR-8257/8+4/SL 10,000.-



CR-YH610/5 4,000.-





CR-8208-1P/SL 14,000.-



CR-YH814/6 9,000.-



CR-8012/5 9,000.-



CR-CF39/6 8,000.-



CR-9011/A 9,000.-



CL-8389/5+1 2,300.-



CL-6028/3 3,600.-



CL-5565/6 3,600.-



CL-PP006/6+1 1,800.-



CL-2696/6+1 1,800.-



CL-8150/3 2,000.-



CL-8888/5+1 2,200.-



CH-6004/5 2,200.-



CH-6211/5 1,700.-





CH-975/8+4 6,070.-

CH-9053/6+3 3,300.-



CH-6107/5 1,600.-

CL-2575/6+1 3,000.-

CH-2006/6+3 3,000.-

CH-5025/5+1 2,000.-



CL-9301/6 1,800.-

CL-8151/3 2,000.-

CH-35052D/5 2,800.-

CH-34389A/5 2,400.-



Table & Floor

เป็นโคมไฟที่ให้ประโยชน์ทั้งด้านฟังก์ชันและการตกแต่งเพื่อความสวยงามมากกว่าแค่ “แสงสว่าง” เพราะถ้าเลือกดีๆ โคมไฟ จะกลายเป็น “ของตกแต่ง” ชั้นเยี่ยมในบ้านคุณ



FTT-NEWYORK/PG 2,000.-



FTT-NEWYORK/BK 1,200.-



FTT-NOOF/WH 880.-



FTT-NOOF/BK 880.-



FTT-NOOF/RD 880.-



FTT-LIPPO/WH 2,000.-



FTT-CITA/WH 2,500.-



FTT-REKER/BK 2,400.-





FTF-MIMOSA/WH 1,800.-



FTF-NOOF/WH 2,000.-





IDENTITY YOUR STYLE

89/18-19 หมู่.5 ตำบลพันท้ายนรสิงห์ อำเภอเมืองสมุทรสาคร จังหวัดสมุทรสาคร 74000

Tel. : 034-872-577, 034-446258, 034-446265 Fax : 034-872566, 034-446267

WWW.LIGHTTRIO.COM



LINE OFFICIAL



WEBSITE