



YOUR **INDENTITY**
YOUR **STYLE**

 Light-trio
OUTDOOR

NEW PRODUCT 2020





WM-M1254L/LED
3,000.-



WM-M1252L/LED
2,900.-



WM-M1674L/LED
1,800.-



WM-M1672L/LED
1,800.-

Material: Die-casting aluminum + Frost PC
 Voltage: 200-240V, 50/60Hz
 LED(C.T): 2700K~6500K
 Body Color: Dark Grey / Silver / White / Rust

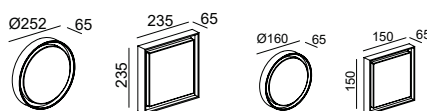

Model	LED Watt	Luminous Flux	Beam Angle	CRI	Safety type
WM-M1252L/LED	140xSMD / 14W	1035 lm (3000K)	110°	≥82	IP65 Ⓢ Ⓢ Ⓢ Ⓢ Ⓢ Ⓢ
WM-M1254L/LED	140xSMD / 14W	1060 lm (3000K)	110°	≥82	IP65 Ⓢ Ⓢ Ⓢ Ⓢ Ⓢ Ⓢ
WM-M1672L/LED	80xSMD / 9W	550 lm (3000K)	110°	≥82	IP65 Ⓢ Ⓢ Ⓢ Ⓢ Ⓢ Ⓢ
WM-M1674L/LED	80xSMD / 9W	550 lm (3000K)	110°	≥82	IP65 Ⓢ Ⓢ Ⓢ Ⓢ Ⓢ Ⓢ

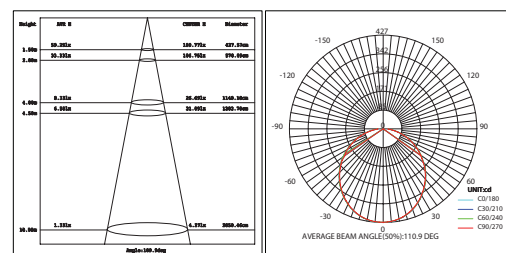



Solar energy lamp

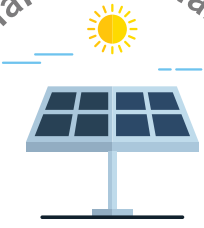

Solar Panel
Voltage / Currency 3.84V/135mA
Battery 1xNi-MHAA2200mAh
Light Time 18h



SOLAR-WM-M1901



Infrared Sensor

Sensor

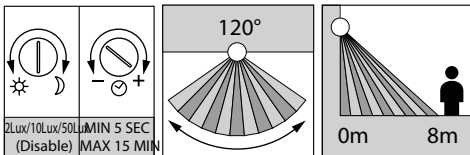

Material: Die-casting aluminum + Frost PC
Voltage 200-240V, 50/60Hz
LED(C.T) 2700K~6500K
Body Color Dark Grey / Silver / White / Rust

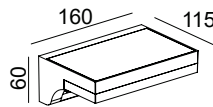

Model	LED Watt	Luminous Flux	Beam Angle	CRI	Safety type
SOLAR-WM-M1901	30xSMD / 3W	150 lm (3000K)	110°	≥82	IP65 Ⓢ Ⓡ Ⓢ Ⓣ Ⓤ Ⓥ Ⓦ Ⓧ Ⓨ Ⓩ ⓐ ⓑ ⓓ ⓔ ⓕ ⓖ ⓗ ⓘ ⓙ ⓚ ⓛ ⓭ ⓮ ⓯ ⓰ ⓱ ⓲ ⓳ ⓴ ⓵ ⓶ ⓷ ⓸ ⓹ ⓺ ⓻ ⓼ ⓽ ⓾ ⓿

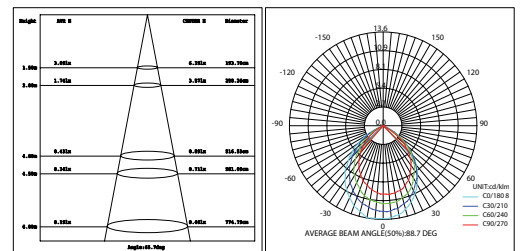





WM-M1997
1,800.-



WM-M1993/LED
2,600.-

Material: Die-casting aluminum + Frost PC+Clear glass
 Voltage: 200-240V, 50/60Hz
 LED(C.T): 2700K~6500K
 Body Color: Dark Grey / Silver / White / Rust

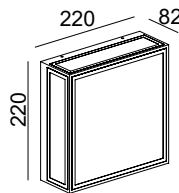

Model	LED Watt	Luminous Flux	Beam Angle	CRI	Safety type
WM-M1993/LED	48xSMD / 14W	760 lm (3000K)	140°	≥82	IP65 Ⓢ Ⓢ Ⓢ CE
WM-M1997	E27(A60) / 15W				IP65 Ⓢ Ⓢ Ⓢ CE

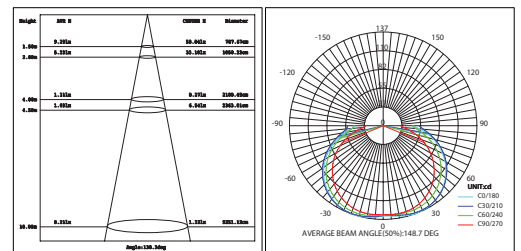





WM-M1975
1,200.-



WM-M1976
1,400.-



WM-M1977
1,500.-

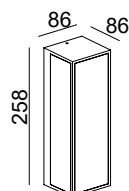
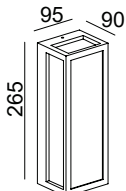
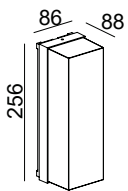

Material: Die-casting aluminum + Clear PC
 Voltage: 220-240V, 50/60Hz
 Lamp Type: E27(A60)
 Lamp Watt: max. 15W
 Body Color: Dark Grey / Silver / White / Rust

E27LED



IP65









WM-M1712/LED
2,400.-

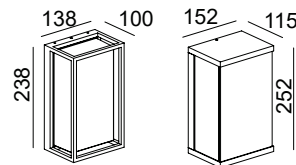

WM-M1621/LED
2,200.-

Material: Die-casting aluminum + Clear PC+Frost PC+Clear glass
 Voltage: 200-240V, 50/60Hz
 LED(C.T): 2700K~6500K
 Body Color: Dark Grey / Silver / White / Rust



Model	LED Watt	Luminous Flux	Beam Angle	CRI	Safety type
WM-M1712/LED	32xSMD / 9W	640 lm (3000K)	138°	≥82	IP65  
WM-M1621/LED	32xSMD / 9W	490 lm (3000K)	148°	≥82	IP65  

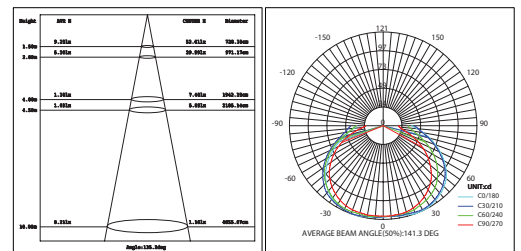





UD-M1953/1
880.-



UD-M1963/1
880.-



UD-M1951/2
1,000.-



UD-M1961/2
1,000.-

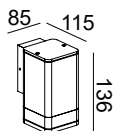
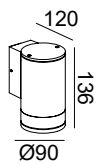
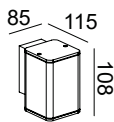
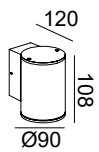

Material: Die-casting aluminum + Clear glass
 Voltage: 220-240V, 50/60Hz
 Lamp Type: GU10
 Lamp Watt: max. 35W
 Body Color: Dark Grey / Silver / White / Rust

GU10LED



IP54



UD-M1954/1
950.-



UD-M1964/1
950.-



UD-M1952/2
1,250.-



UD-M1962/2
1,250.-

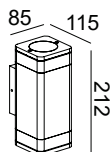
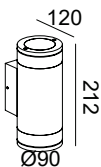
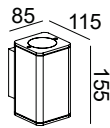
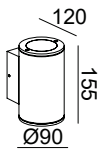

Material: Die-casting aluminum + Clear glass
 Voltage: 220-240V, 50/60Hz
 Lamp Type: GU10
 Lamp Watt: max. 35W
 Body Color: Dark Grey / Silver / White / Rust

GU10LED



IP54

 CEILING DOWNLIGHT



DB-M1955
740.-



DB-M1965
740.-



DB-M1956
810.-



DB-M1966
810.-

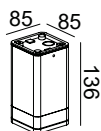
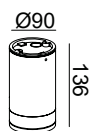
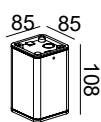
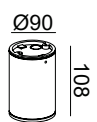

Material: Die-casting aluminum + Clear glass
 Voltage: 220-240V, 50/60Hz
 Lamp Type: GU10
 Lamp Watt: max. 35W
 Body Color: Dark Grey / Silver / White / Rust

GU10LED



IP54





Solar energy lamp

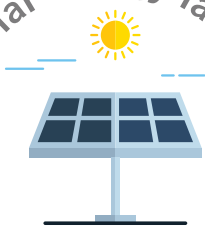

Solar Panel 2Watt
 Voltage / Currency 3.84V/135mA
 Battery 1xNi-MHAA2200mAh
 Light Time 18h



SOLAR-BOL-M1911
2,500.-



SOLAR-WM-M1911-50
3,000.-

Sensor

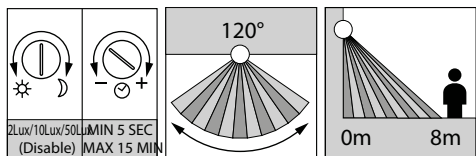

Material: Die-casting aluminum + Frost PC
 Voltage 200-240V, 50/60Hz
 LED(C.T) 2700K~6500K
 Body Color Dark Grey / Silver / White / Rust

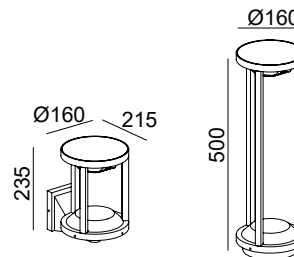

Model	LED Watt	Luminous Flux	Beam Angle	CRI	Safety type
SOLAR-BOR-M1911	20xSMD / 2W	135 lm (3000K)	120°	≥82	IP65
SOLAR-WM-M1911-50	20xSMD / 2W	135 lm (3000K)	120°	≥82	IP65

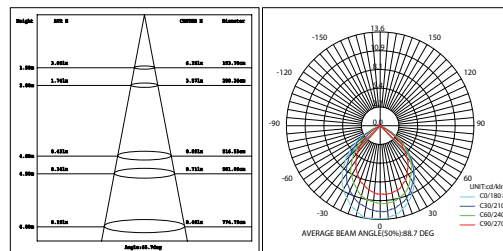





UD-M2021
2,200.-



BOL-M2022-50
3,100.-



BOR-M2022
1,700.-

Material: Die-casting aluminum + Clear PC
 Voltage: 220-240V, 50/60Hz
 Lamp Type: E27(A60)
 Lamp Watt: max. 15W
 Body Color: Dark Grey / Silver / White / Rust

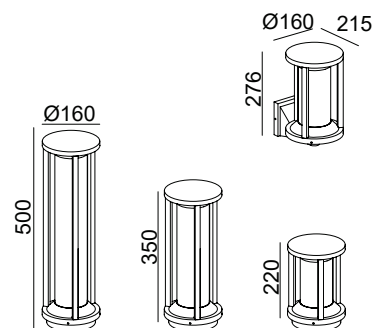

E27LED   

IP65





UD-M1931
2,200.-



BOL-M1932-50
3,100.-



BOR-M1932
1,700.-

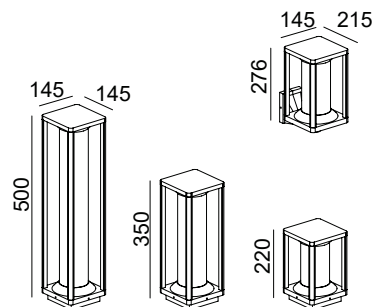

Material: Die-casting aluminum + Clear PC
 Voltage: 220-240V, 50/60Hz
 Lamp Type: E27(A60)
 Lamp Watt: max. 15W
 Body Color: Dark Grey / Silver / White / Rust

E27LED



IP65









BOR-M1762/LED
3,000.-

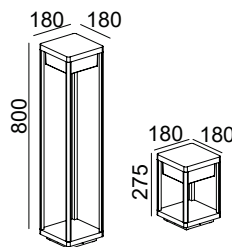

BOL-M1762/LED-80
4,000.-

Material: Die-casting aluminum + Frost PC
 Voltage: 200-240V, 50/60Hz
 LED(C.T): 2700K~6500K
 Body Color: Dark Grey / Silver / White / Rust



Model	LED Watt	Luminous Flux	Beam Angle	CRI	Safety type
BOR-M1762/LED	32xSMD / 9W	450 lm (4000K)	16°	≥82	IP65  
BOL-M1762/LED-800	32xSMD / 9W	540 lm (4000K)	16°	≥82	IP65  

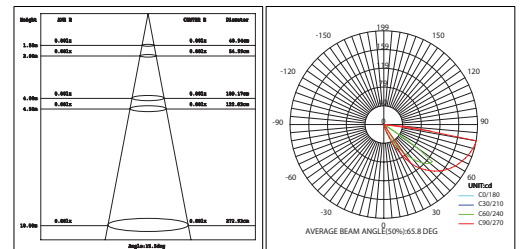





BOL-M1761/LED-80



BOR-M1761/LED

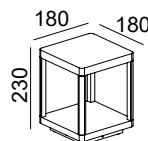
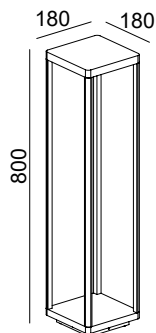

Material: Die-casting aluminum + Clear glass
 Voltage: 200-240V, 50/60Hz
 LED(C.T): 2700K~6500K
 Body Color: Dark Grey / Silver / White / Rust

Model	LED Watt	Luminous Flux	Beam Angle	CRI	Safety type
BOL-M1761/LED-80	1x7W / CREE	445 lm (4000K)	16°	≥82	IP65
BOR-M1761/LED	1x7W / CREE	445 lm (4000K)	16°	≥82	IP65

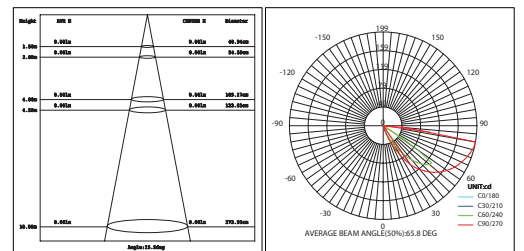
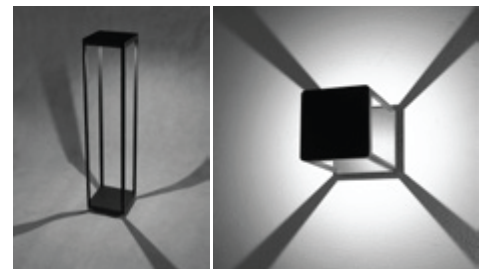



BOL-M1684/LED-65
3,000.-

Material: Die-casting aluminum + Clear PC
 Voltage: 200-240V, 50/60Hz
 LED(C.T): 2700K~6500K
 Body Color: Dark Grey / Silver / White / Rust

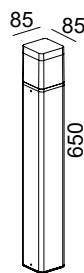
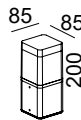
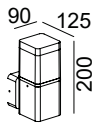

UD-M1684L/LED
2,200.-

Model	LED Watt	Luminous Flux	Beam Angle	CRI	Safety type
UD-M1684L/LED	32xSMD / 9W	422 lm (3000K)	115°	≥82	IP65 Ⓢ Ⓢ Ⓢ CE
BOL-M1684L/LED-65	32xSMD / 9W	422 lm (3000K)	115°	≥82	IP65 Ⓢ Ⓢ Ⓢ CE

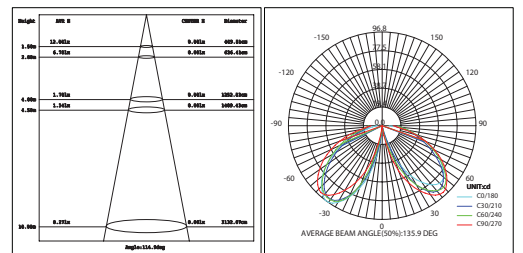



BOL-M1683L/LED-65
3,000.-



UD-M1683L/LED
2,200.-

Material: Die-casting aluminum + Clear PC
 Voltage: 200-240V, 50/60Hz
 LED(C.T): 2700K~6500K
 Body Color: Dark Grey / Silver / White / Rust

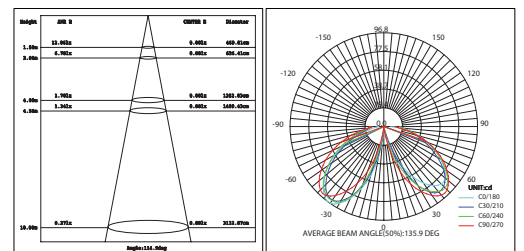
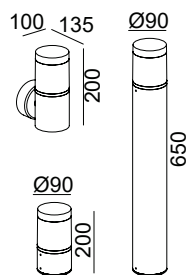

Model	LED Watt	Luminous Flux	Beam Angle	CRI	Safety type
UD-M1683L/LED	32xSMD / 9W	376 lm (3000K)	115°	≥82	IP65
BOL-M1683L/LED-65	32xSMD / 9W	376 lm (3000K)	115°	≥82	IP65





BOR-M1392
1,900.-



BOR-M1391
2,300.-



BOR-M1393
N/A

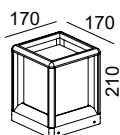
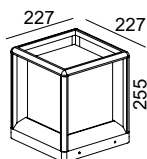
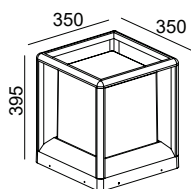

Material: Die-casting aluminum + Frost PC
 Voltage: 220-240V, 50/60Hz
 Lamp Type: E27
 Lamp Watt: max. 20W
 Body Color: Dark Grey / Silver / White / Rust



E27PL



IP65



UP-M1733/COB7
2,400.-



UP-M1732/COB7
2,200.-

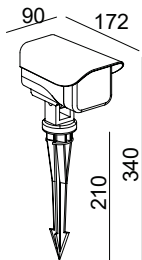
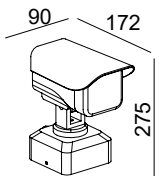

Material: Die-casting aluminum + Frost PC
 Voltage: 200-240V, 50/60Hz
 LED(C.T): 2700K~6500K
 Body Color: Dark Grey / Silver / White / Rust

Model	LED Watt	Luminous Flux	Beam Angle	CRI	Safety type
UP-M1733/COB7	4x2W / CREE	417 lm (3000K)	52°	≥83	IP65 Ⓢ Ⓢ Ⓢ Ⓢ Ⓢ Ⓢ
UP-M1732/COB7	1x7W / CREE	526 lm (3000K)	11°	≥82	IP65 Ⓢ Ⓢ Ⓢ Ⓢ Ⓢ Ⓢ

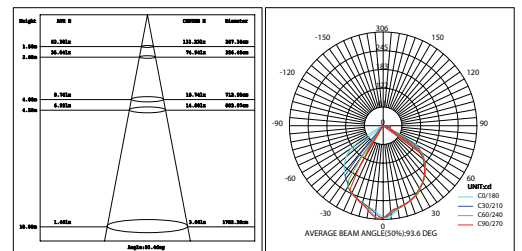



WALL SURFACE / GROUND SURFACE



UP-M1101/LED5
2,400.-



Adjustable

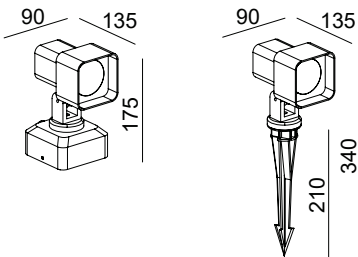

Adjustable

UP-M1741/LED7
2,100.-



UP-M1742/LED7
1,900.-

Material: Die-casting aluminum + Clear glass
Voltage: 200-240V, 50/60Hz
LED(C.T): 2700K~6500K
Body Color: Dark Grey / Silver / White / Rust

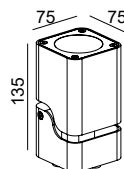

Model	LED Watt	Luminous Flux	Beam Angle	CRI	Safety type
UP-M1101/LED5	1x5W CREE	296 lm (3000K)	39°	≥82	IP65 ⚡ ⚠ ⚡
UP-M1741/LED7	1x7W / CREE	432 lm (3000K)	15°	≥82	IP65 ⚡ ⚠ ⚡
UP-M1742/LED7	1x7W / CREE	432 lm (3000K)	15°	≥82	IP65 ⚡ ⚠ ⚡

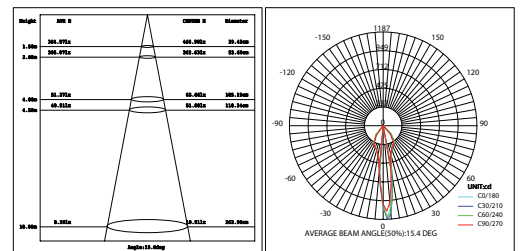

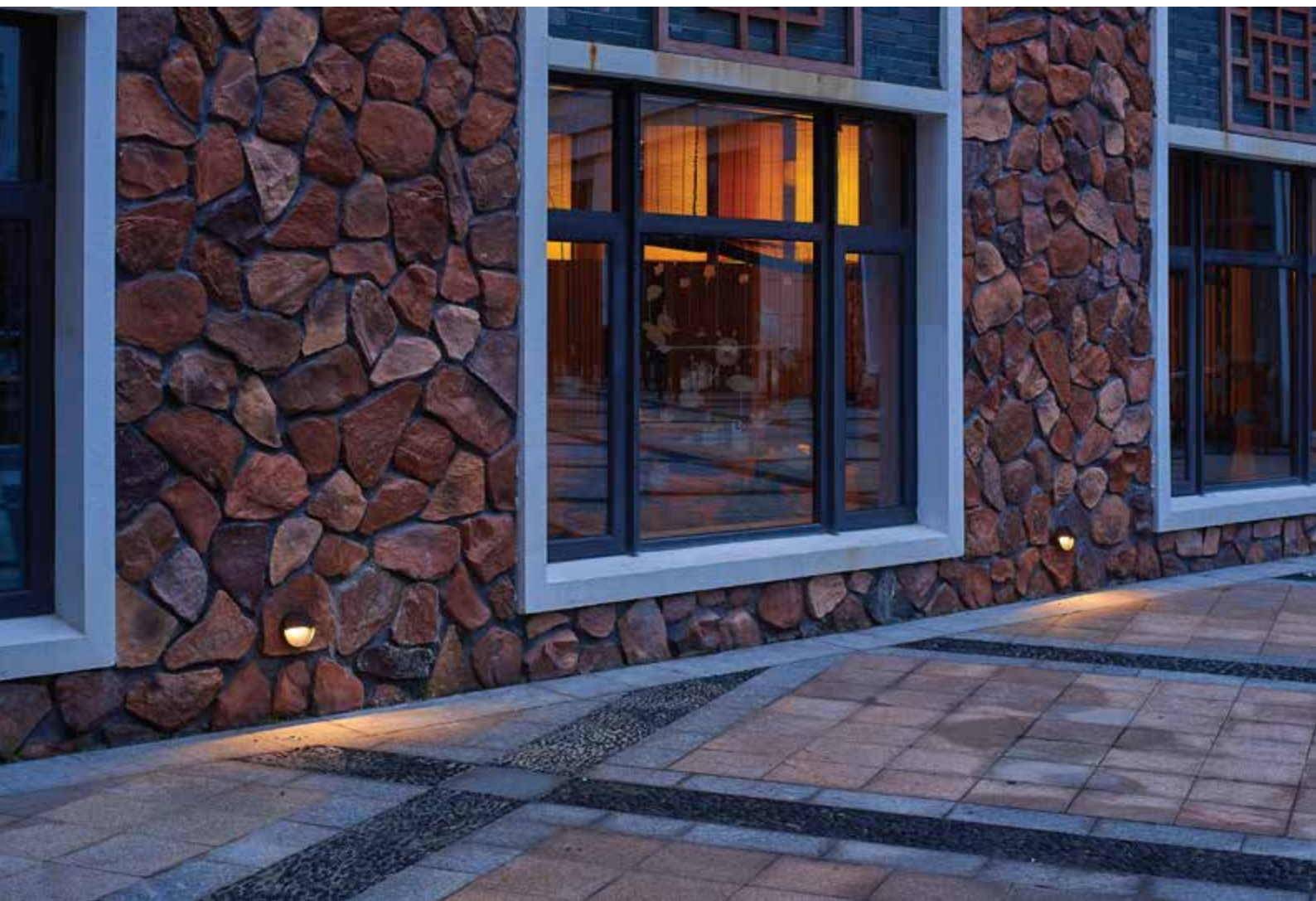



STEP-M1441/LED
950.-







STEP-M1442/LED
950.-

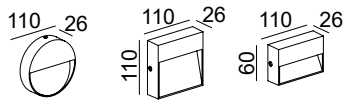

STEP-M1443/LED
950.-

Material: Die-casting aluminum + Clear PC
 Voltage: 200-240V, 50/60Hz
 LED(C.T): 2700K~6500K
 Body Color: Dark Grey / Silver / White / Rust



Model	LED Watt	Luminous Flux	Beam Angle	CRI	Safety type
STEP-M1441/LED	10xSMD / 1.5W	45 lm (3000K)	37°	≥82	IP65  
STEP-M1442/LED	10xSMD / 1.5W	45 lm (3000K)	37°	≥82	IP65  
STEP-M1443/LED	10xSMD / 1.5W	45 lm (3000K)	37°	≥82	IP65 