

**CONTENT OF**

**OUTDOOR**

**LIGHT 2013**

# COMPANY PROFILE

หจก.อิทธิฤทธิ์ อิเลคตริค ก่อตั้งขึ้นเมื่อ พ.ศ.2538 โดยบริษัทดำเนินธุรกิจตั้งแต่การออกแบบ การผลิต การนำเข้า การส่งออก ตลอดจนการให้คำแนะนำเกี่ยวกับผลิตภัณฑ์ไฟฟ้าแสงสว่างให้กับลูกค้าทั้งในและต่างประเทศ ลูกค้าของทางบริษัทมีตั้งแต่ลูกค้าในกลุ่มขายส่ง - ขายปลีก ผู้รับเหมามาจนถึงลูกค้าและเจ้าของโครงการขนาดใหญ่

หจก.อิทธิฤทธิ์ อิเลคตริค ผลิตและจำหน่ายสินค้าภายใต้ตราสินค้า "ITE" โดยสินค้าของห้างฯ มีตั้งแต่ผลิตภัณฑ์สำหรับใช้ภายในอาคาร เช่น โคมไฟฟลูออเรสเซนต์ โคมไฟดาวไลท์ โคมติดเพดาน โคมไฟไฮเบย์-โลเบย์ จนถึงผลิตภัณฑ์สำหรับใช้ภายนอกอาคาร เช่น โคมสวน โคมไฟได้นำ โคมไฟหัวเสา โคมฉาย โคมไฟถนน เป็นต้น นอกจากนี้ทางห้างหุ้นส่วนจำกัดฯ ยังมีบริการออกแบบและพัฒนาผลิตภัณฑ์สำหรับการใช้งานพิเศษเฉพาะทาง การบริการคำนวณการกระจายแสงและการใช้พลังงาน การพัฒนาโคมไฟประหยัดพลังงานรวมถึงรับผลิตโคมไฟภายใต้แบรนด์ต่าง ๆ อีกมากมาย

โดยปัจจุบัน ทางห้างหุ้นส่วนจำกัดฯ ได้พัฒนาสินค้าเพิ่มขึ้นในกลุ่มลูกค้าเกรด A โดยพัฒนาสินค้าใหม่ ที่มีคุณภาพสูงภายใต้ตราสินค้าใหม่ "LIGHTTRIO" โดยได้ออกสู่ตลาดแล้วในปี 2550 เปิดตัวในงานสถาปนิก 51 ทางห้างหุ้นส่วนจำกัดฯ ยินดีให้คำปรึกษาด้านการออกแบบแสงสว่างโดยผู้เชี่ยวชาญ สำหรับสินค้าอื่นๆ ที่ไม่ปรากฏอยู่นี้ ทางห้างหุ้นส่วนจำกัดฯ สามารถผลิตตามความต้องการของลูกค้าในคุณภาพ และราคาที่ลูกค้าพอใจได้

หวังเป็นอย่างยิ่งว่า ทางห้างหุ้นส่วนจำกัดฯ จะมีโอกาสได้บริการและรับใช้ทุกท่านในเร็วๆ นี้

Download App-catalogue From  
For iPad



App Store

Search Lighttrio



LightTrio



ONLINE CATALOG AND DOWNLOAD LIGHTTRIO PDF CATALOG VERSION INTO YOUR GADGET AT [WWW.LIGHTTRIO.COM](http://WWW.LIGHTTRIO.COM)

# Content

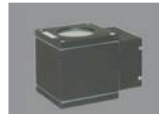

UD SERIES



WM SERIES



STEP SERIES



LED SERIES



UP SERIES



BOL SERIES

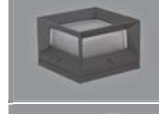

BOR SERIES



LW SERIES



IN SERIES



PT SERIES



ESPL SERIES



DOWNLIGHT SERIES

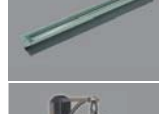

FLUORESCENT SERIES



CLASSIC SERIES



SOLAR SERIES

# UD SERIES



UD-1818-1-GU10

GU10 50W

GU10 LED SW

1,500.-

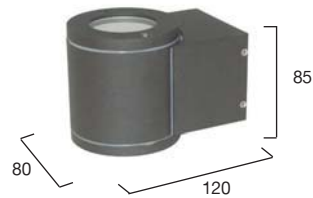

UD-1818-2-GU10

GU10 50Wx2

GU10 LED SWx2

1,800.-

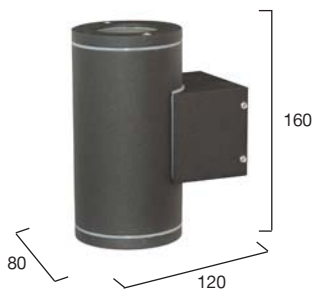

Material : Aluminum

Voltage : 220-240V 50Hz

110-130V 60Hz

UD-1 | LIGHTTRIO



## UD-1819-1-GU10

GU10 SOW  
GU10 LED SW

1,600.-

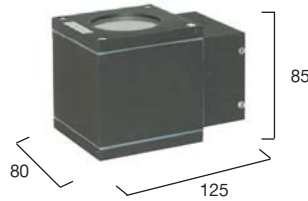

## UD-1819-2-GU10

GU10 SOWx2  
GU10 LED SWx2

2,000.-

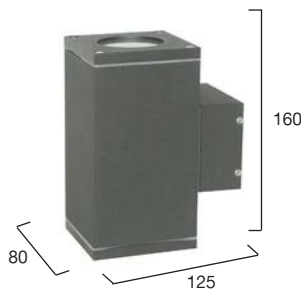

## UD-1857-G9

G9 SOW  
G9 LED 3W

1,600.-

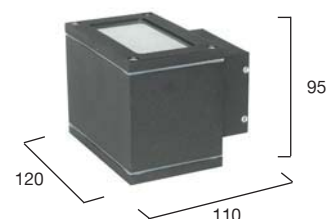

Material : Aluminum  
Voltage : 220-240V 50Hz  
110-130V 60Hz

# UD SERIES



UD-1879-1-GU10

GU10 50W

GU10 LED SW

1,450.-

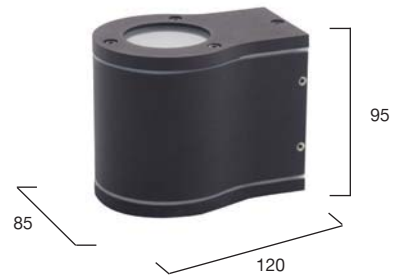

UD-1879-2-GU10

GU10 50Wx2

GU10 LED SWx2

2,050.-



Material : Aluminum  
Voltage : 220-240V 50Hz  
110-130V 60Hz



## UD-1880-01-PAR30

E27 PAR30 75W  
E27 LED PAR30 12W

2,050.-

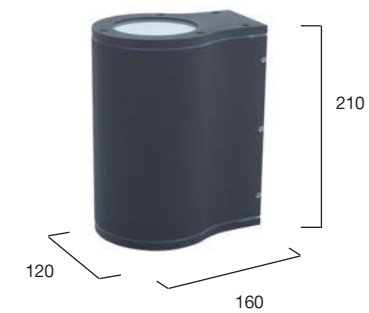

## UD-1880-02-PAR30

E27 PAR 30 75Wx2  
E27 LED PAR 30 12Wx2

2,340.-



Material : Aluminum  
Voltage : 220-240V 50Hz  
110-130V 60Hz

# UD SERIES



UD-1824-GU10

GU10 SOW  
GU10 LED SW  
1,640.-



(ปรับองศาได้)

UD-1826-GU10

GU10 SOW  
GU10 LED SW  
1,780.-

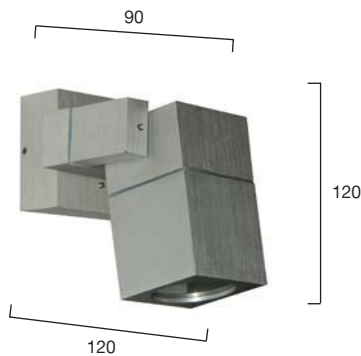

(ปรับองศาได้)

Material : Aluminum  
Voltage : 220-240V 50Hz  
110-130V 60Hz



UD-161

E27 GENIE 11W  
E27 PAR20 50W

950.-

UD-162

E27 GENIE 11W  
E27 PAR20 50W

1,250.-



Material : Aluminum  
Voltage : 220-240V 50Hz  
110-130V 60Hz

# UD SERIES

UD-171

E27 GENIE 14W

1,100.-

UD-172

E27 GENIE 14W

1,600.-



Material : Aluminum  
Voltage : 220-240V 50Hz  
110-130V 60Hz

UD-191

E27 GENIE 11W  
E27 PAR20 SOW

1,200.-

UD-192

E27 GENIE 11W  
E27 PAR20 SOW

1,600.-



Material : Aluminum  
Voltage : 220-240V 50Hz  
110-130V 60Hz

# UD SERIES

## UD-202

E27 TORNADO 24W

E27 PAR38 120W

2,800.-

## UD-201

E27 TORNADO 24W

E27 PAR38 120W

2,300.-

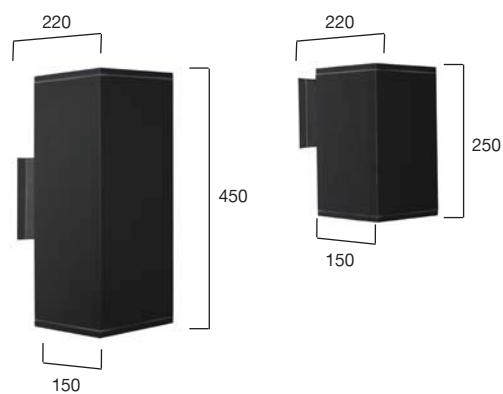

Material : Aluminum  
Voltage : 220-240V 50Hz  
110-130V 60Hz

UD-9 LIGHTTRIO

UD-2S10

E27 GENIE 18W

2,000.-



UD-2S11

E27 GENIE 18W

2,400.-



UD-2S12

E27 TORNADO 24W

4,500.-



Material : Aluminum, Glass  
Voltage : 220-240V 50Hz  
110-130V 60Hz

# UD SERIES

UD-2611

E27 GENIE 18W

2,300.-

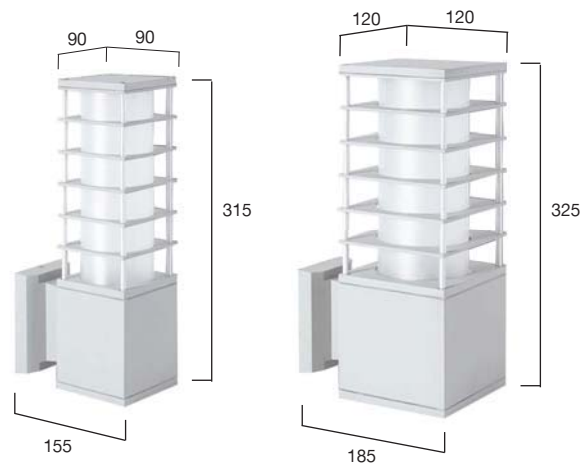
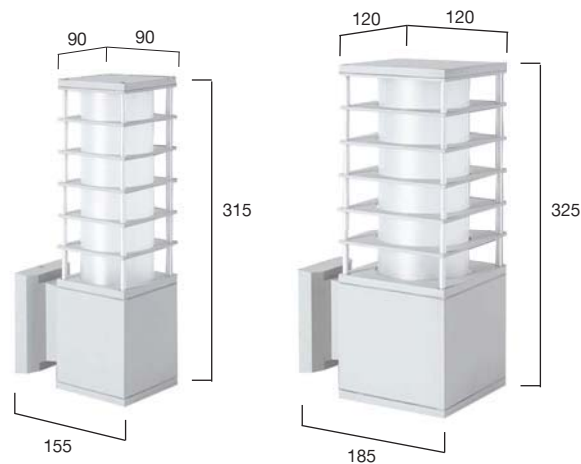

UD-2610

E27 GENIE 18W

2,000.-



Material : Aluminum, Glass  
Voltage : 220-240V 50Hz  
110-130V 60Hz

UD-11 | LIGHTTRIO

UD-280

E27 GENIE 18W

1,250.-

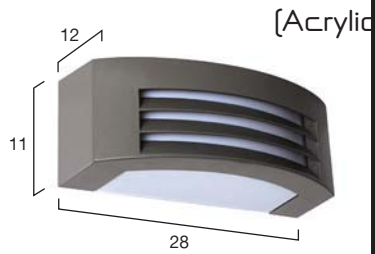

UD-290

E27 TORNADO 12W

900.-

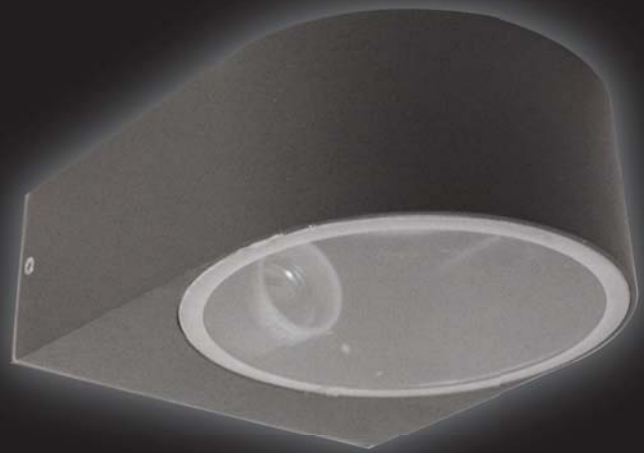
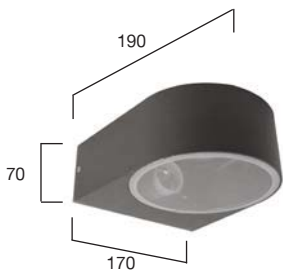

UD-300

E27 GENIE 14W

2,500.-



Material : Aluminum  
 Voltage : 220-240V 50Hz  
 110-130V 60Hz

# UD SERIES



## UD-310

E27 GENIE 18W

3,600.-

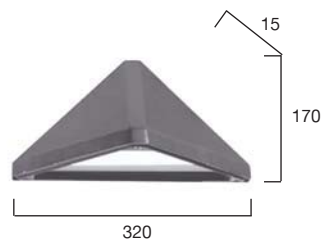

## UD-320

E27 GENIE 14W

2,200.-

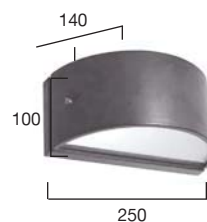

## UD-330

Rx7S-MH150W

Rx7S-HPS150W

3,500.- (ราคาไม่รวมภาษี)



Material : Aluminum  
Voltage : 220-240V 50Hz  
110-130V 60Hz



# UD SERIES

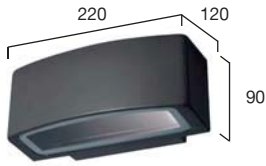

**UD-340**

E27 GENIE 11W  
1,100.-

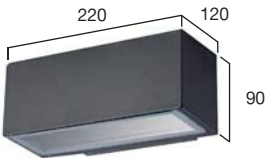

**UD-350**

E27 GENIE 11W  
1,100.-

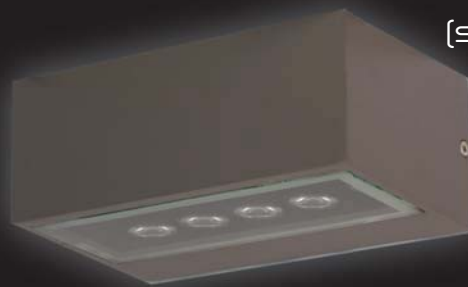
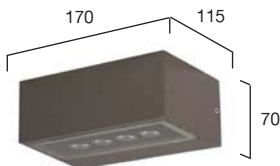

**UD-360/LED4W**

LED 4W 220V (3000K)  
1,500.-  
(ราคาครบชุดพร้อม LED)

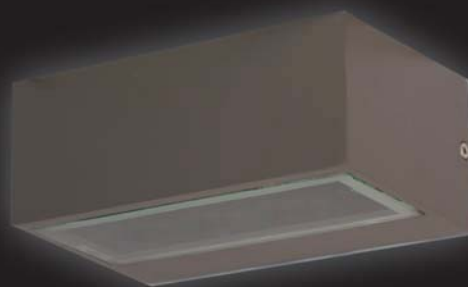
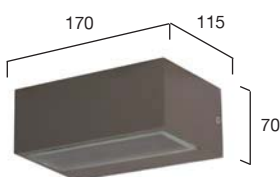

**UD-360**

E27 GENIE 8W  
900.-

Material : Aluminum  
Voltage : 220-240V 50Hz  
110-130V 60Hz

# UD SERIES

## UD-370

G9 LED 3W

G9 SOW

1,100.-

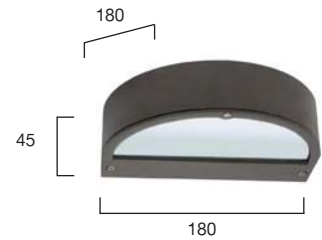

## UD-380

E27 GENIE 11W

2,400.-

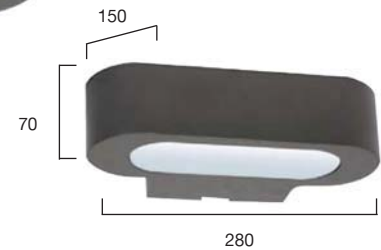

## UD-390

E27 GENIE 18W

1,600.-

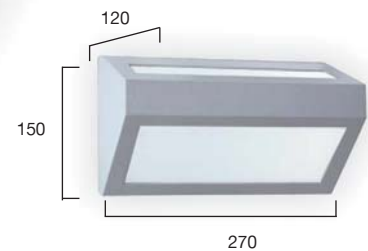

## UD-400

E27 GENIE 18W

1,600.-

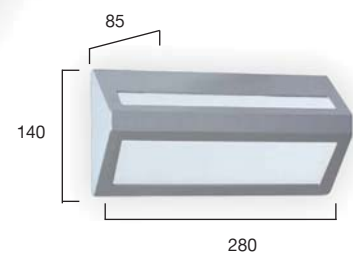
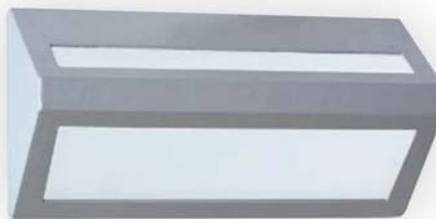

Material : Aluminum  
Voltage : 220-240V 50Hz  
110-130V 60Hz

# UD SERIES

UD-412

E27 Tornado15W

2,000.-



UD-411

E27 Tornado15W

1,600.-

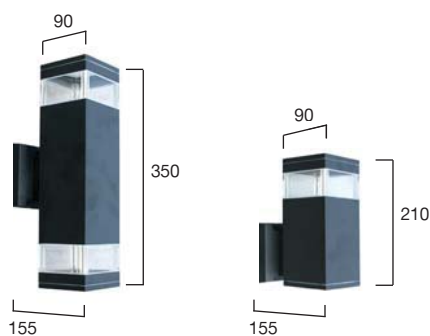

Material : Aluminum  
Voltage : 220-240V 50Hz  
110-130V 60Hz

# UD SERIES

UD-421

E27 GENIE 18W

1,400.-

UD-422

E27 GENIE 18W

1,800.-

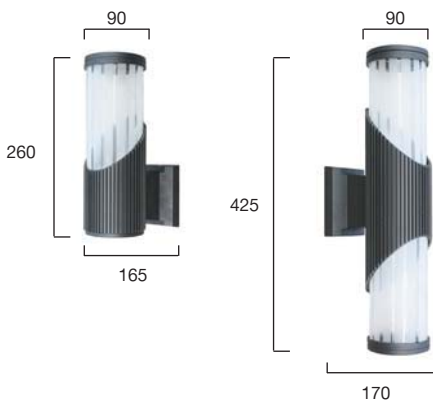
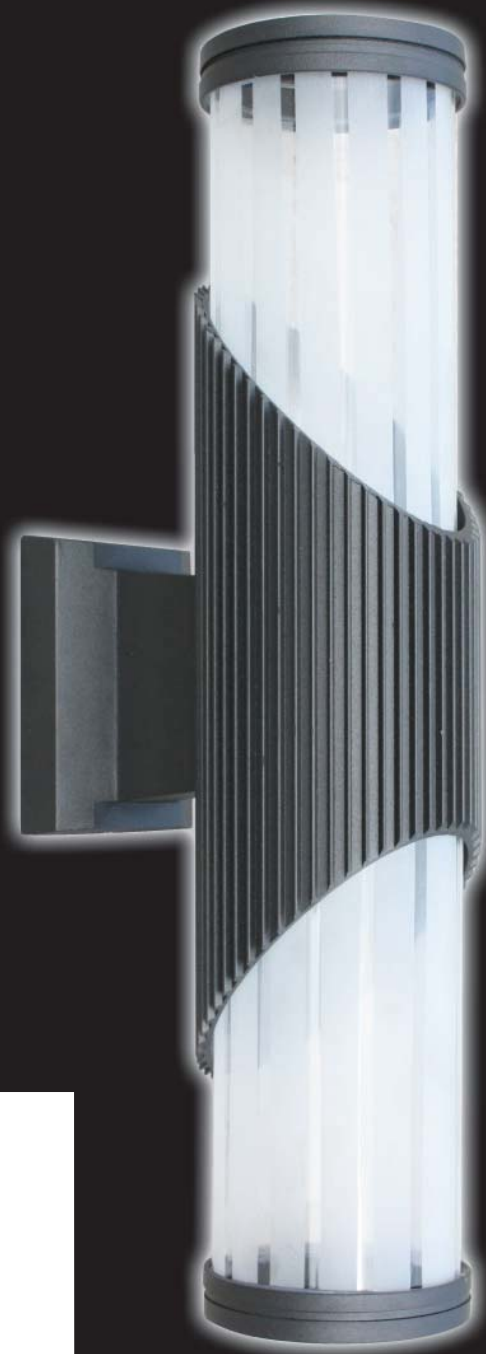
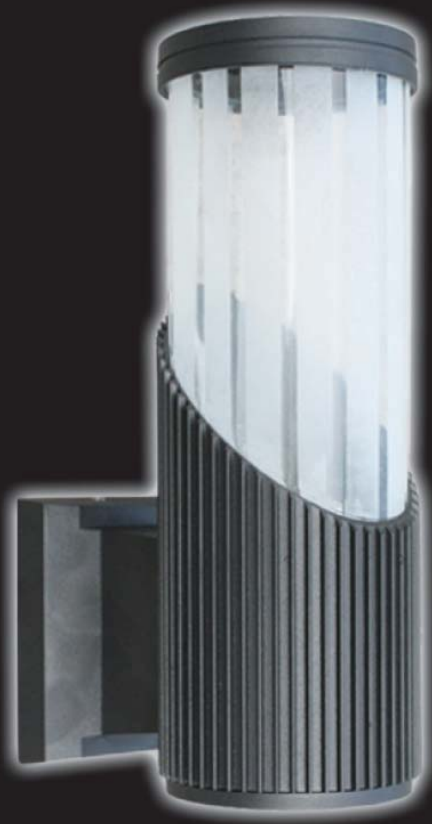

Material : Aluminum  
Voltage : 220-240V 50Hz  
110-130V 60Hz

UD-432

E27 Tornado15W

1,800.-

UD-431

E27 Tornado15W

1,600.-

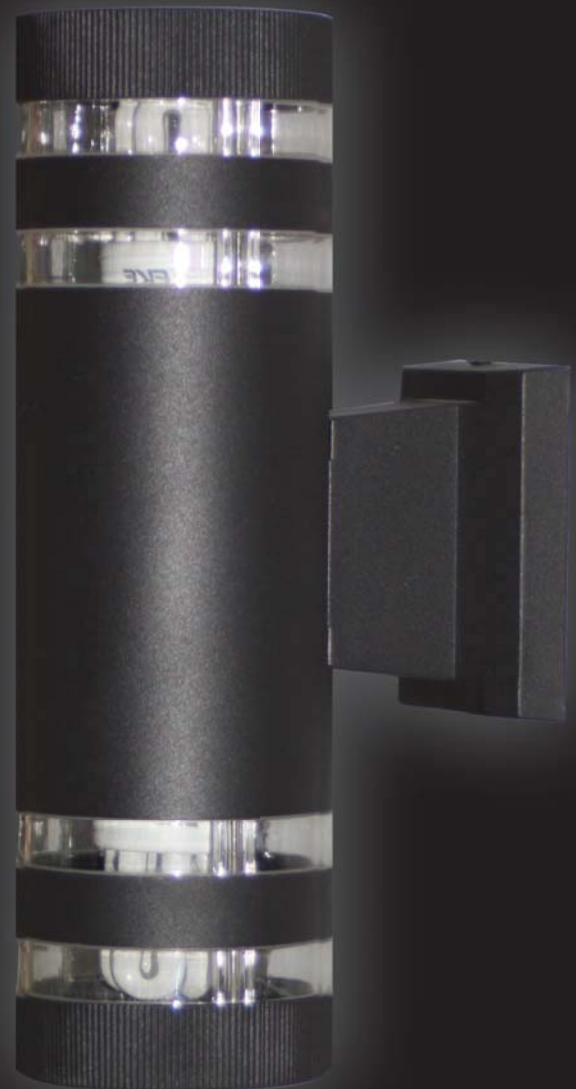

Material : Aluminum  
Voltage : 220-240V 50Hz  
110-130V 60Hz

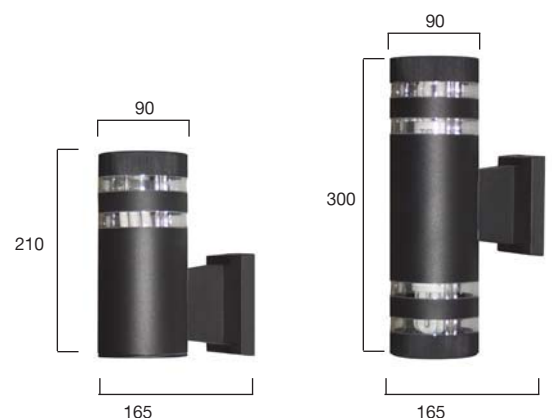

# UD SERIES



UD-440

E27 GENIE 18W

1,800.-

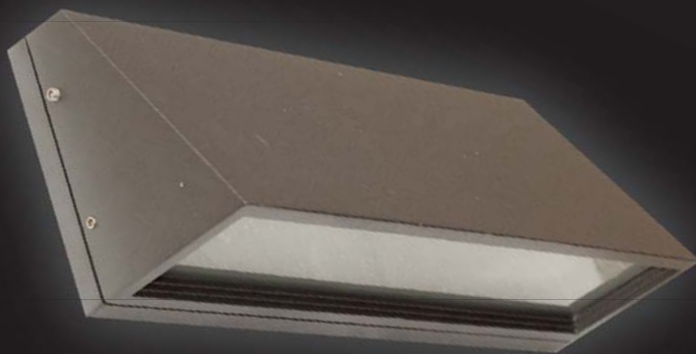

UD-450

E27 GENIE 18W

1,800.-

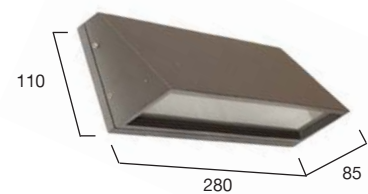

Material : Aluminum  
Voltage : 220-240V 50Hz  
110-130V 60Hz

UD-461

E27 GENIE 18W

1,600.-

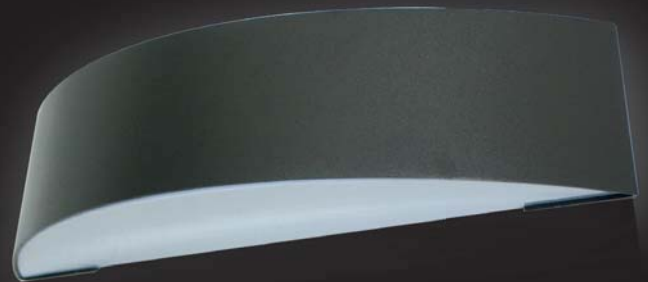

UD-462

E27 GENIE 18W

1,600.-

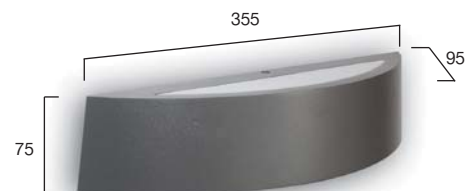

Material : Aluminum  
Voltage : 220-240V 50Hz  
110-130V 60Hz

# UD SERIES

UD-470

E27 GENIE 14W

1,200.-



UD-482

E27 GENIE 11W

1,600.-

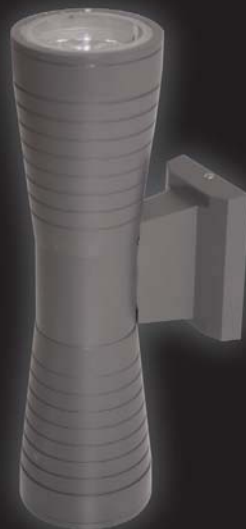

UD-490

E27 GENIE 11W

1,300.-





# UD SERIES

## UD-LED-W0398/9W

LED 9W 3000K 220V

2,500.-

(នាការសម្រាប់រន្ធនៃ LED)



## UD-LED-W0445/3W

LED2x3W 3000K 220V

2,000.-

(នាការសម្រាប់រន្ធនៃ LED)

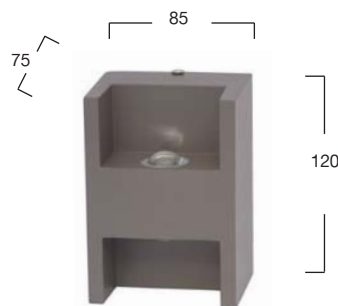

## UD-LED-W0443/4W

LED 3W 3000K 220V

1,800.-

(នាការសម្រាប់រន្ធនៃ LED)

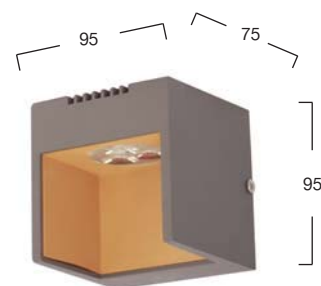

Material : Aluminum  
Voltage : 220-240V 50Hz  
110-130V 60Hz

# UD SERIES



UD-0213/GU10  
GU10 LED 220V SW  
3,552.-



UD-0214/GU10  
GU10 LED 220V SW  
3,480.-



Material : Aluminum  
Voltage : 220-240V 50Hz  
110-130V 60Hz



UD-492

E27 TORNADO 24W

1,800.-

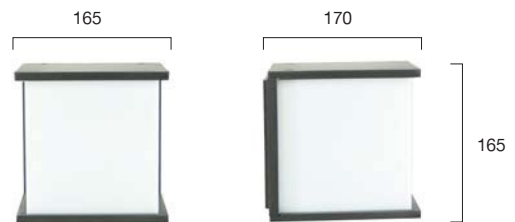

UD-502-GU10

GU10 x 2 LED 220V SW

1,800.-

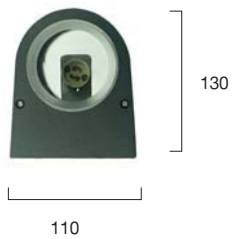

Material : Aluminum  
Voltage : 220-240V 50Hz  
110-130V 60Hz

# WM SERIES

## WM-121

E27 TORNADO 24W

3,400.-

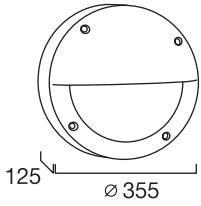

## WM-120

E27 GENIE 18W

1,400.-

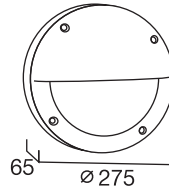

## WM-111

E27 TORNADO 24W

3,000.-

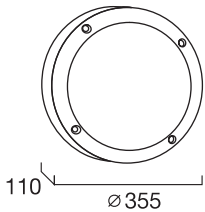

## WM-110

E27 GENIE 18W

1,200.-

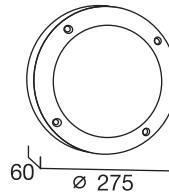

## WM-131

E27 TORNADO 24W

3,400.-

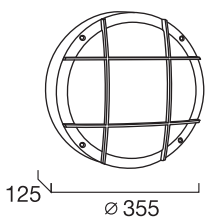

## WM-100

E27 GENIE 18W

1,400.-

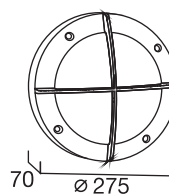

Material : Aluminum, Acrylic  
Voltage : 220-240V 50Hz  
110-130V 60Hz

# WM SERIES

## WM-141

G24 PLC 26W

3,600.-

[พร้อมโคมหลอด 26W]

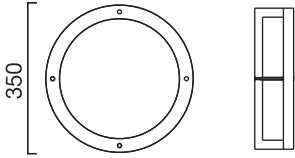
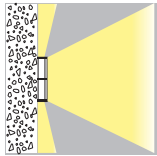

## WM-181

E27 GENIE 18W

1,500.-

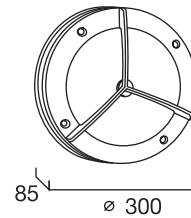

## WM-191

E27 GENIE 18W

1,400.-

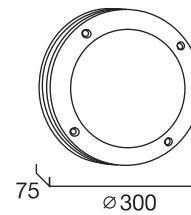

## WM-171

E27 GENIE 18W

1,600.-

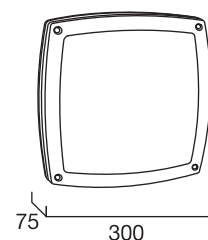

Material : Aluminum, Acrylic  
Voltage : 220-240V 50Hz  
110-130V 60Hz

# WM SERIES

WM-220

E27 GENIE 14W

1,200.-

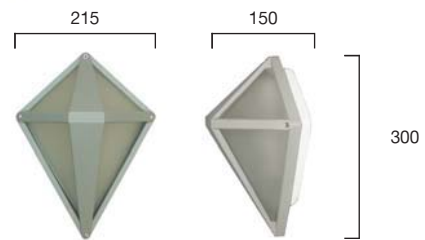

WM-201

E27 GENIE 18W

1,000.-



WM-201-2

E27 GENIE 18W

1,200.-

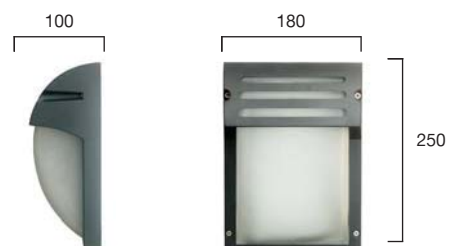

Material : Aluminum, Glass  
Voltage : 220-240V 50Hz  
110-130V 60Hz

# WM SERIES

## WM-230

E27 GENIE 18W

1,600.-

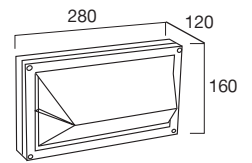
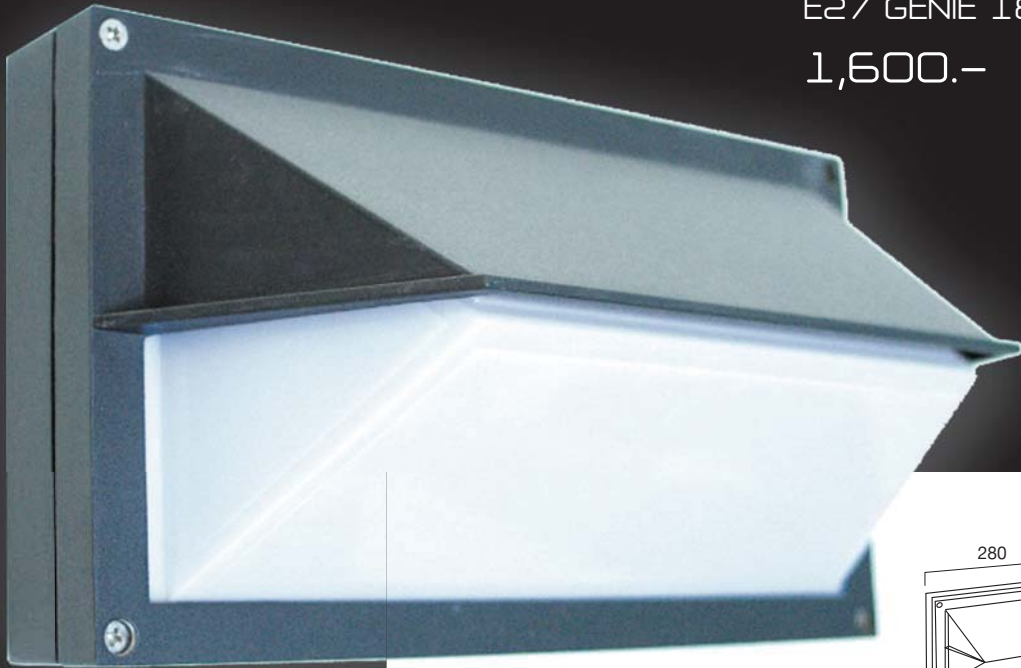

## WM-240

E27 GENIE 18W

1,500.-

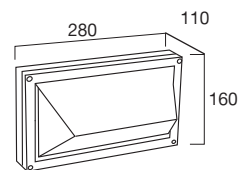

Material : Aluminum, Glass  
Voltage : 220-240V 50Hz  
110-130V 60Hz

# WM SERIES



## WM-251

E27 TORNADO 24W

3,400.-

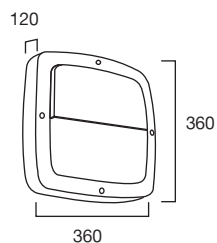

## WM-261

E27 TORNADO 24W

3,000.-

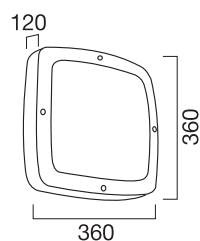

## WM-271

E27 TORNADO 24W

3,400.-

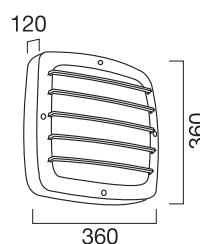

Material : Aluminum, Acrylic  
Voltage : 220-240V 50Hz  
110-130V 60Hz



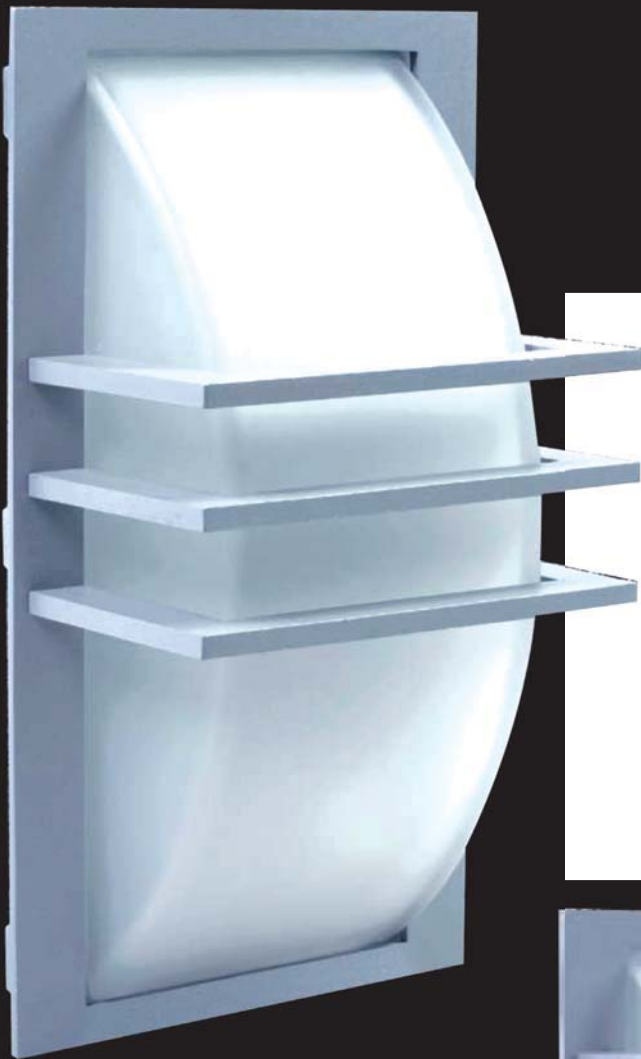

WM-281

E27 GENIE 18W

1,600.-

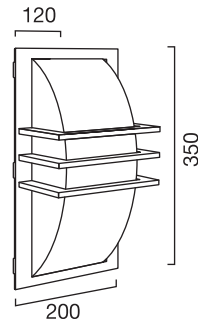

WM-291

E27 GENIE 18W

1,600.-

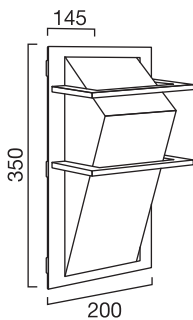

Material : Aluminum, Glass  
Voltage : 220-240V 50Hz  
110-130V 60Hz

# WM SERIES



## WM-300

E27 TORNADO 24W

1,400.-

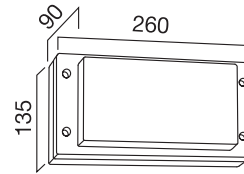

## WM-310

E27 TORNADO 24W

1,600.-

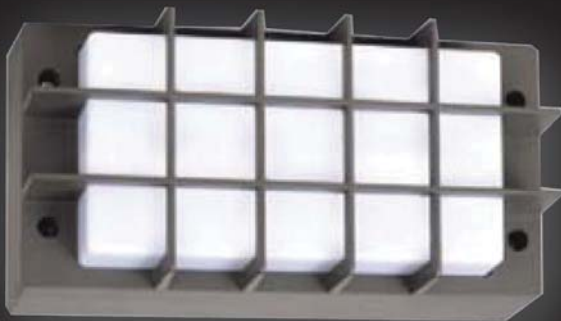
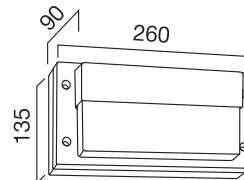

## WM-320

E27 TORNADO 24W

1,600.-

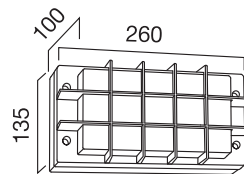

## WM-330

E27 TORNADO 24W

1,600.-

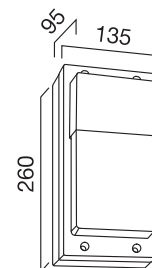

Material : Aluminum, Glass  
Voltage : 220-240V 50Hz  
110-130V 60Hz

WM-351-1

E27 GENIE 18W

1,400.-



WM-341

E27 GENIE 18W

1,400.-



WM-361

E27 GENIE 18W

1,300.-

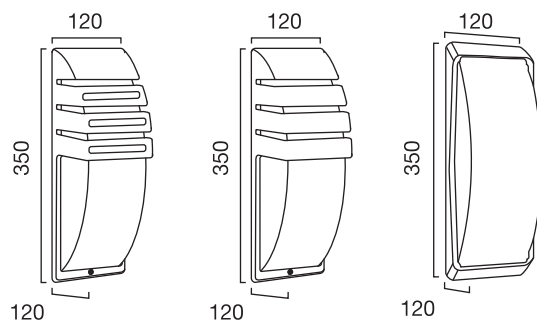

Material : Aluminum, Acrylic  
Voltage : 220-240V 50Hz  
110-130V 60Hz

# WM SERIES

**WM-371**

E27 GENIE 18W

1,300.-



**WM-381**

E27 GENIE 18W

1,300.-



**WM-391**

E27 GENIE 18W

1,300.-



**WM-401**

E27 GENIE 18W

1,250.-

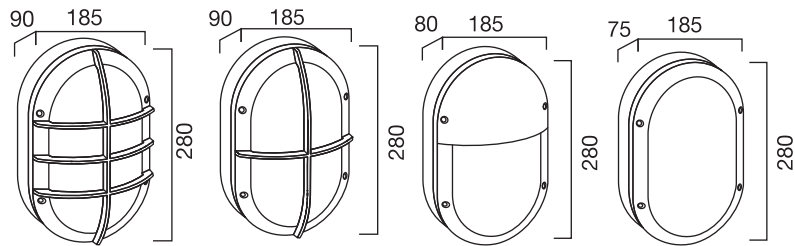

**WM-370**

E27 GENIE 14W

1,000.-



**WM-380**

E27 GENIE 14W

1,000.-



**WM-390**

E27 GENIE 14W

1,000.-



**WM-400**

E27 GENIE 14W

950.-

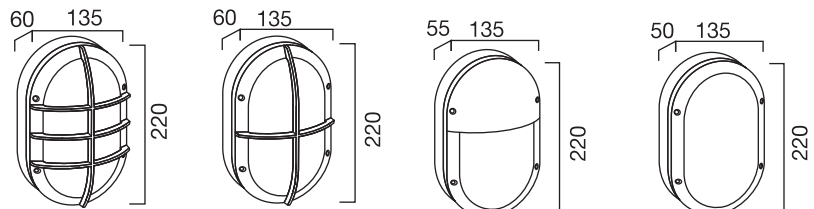

Material : Aluminum, Glass  
Voltage : 220-240V 50Hz  
110-130V 60Hz

# WM SERIES



WM-410

E27 GENIE 14W

1,400.-

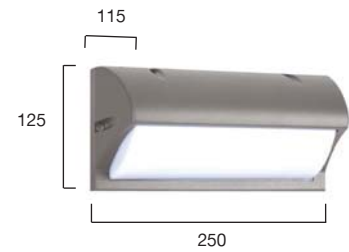

WM-420

E27 GENIE 14W

1,600.-



Material : Aluminum, Glass  
Voltage : 220-240V 50Hz  
110-130V 60Hz

# WM SERIES

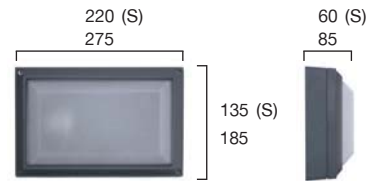

**WM-430**

E27 GENIE 18W

1,600.-

**WM-430/S**

E27 GENIE 14W

900.-

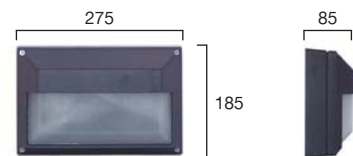

**WM-440**

E27 GENIE 18W

1,600.-



**WM-450**

E27 GENIE 18W

1,600.-

Material : Aluminum, Glass  
 Voltage : 220-240V 50Hz  
 110-130V 60Hz

# WM SERIES

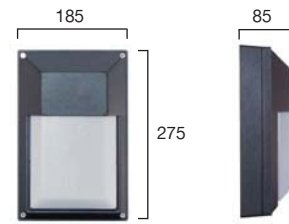

**WM-460**  
E27 GENIE 18W  
1,600.-

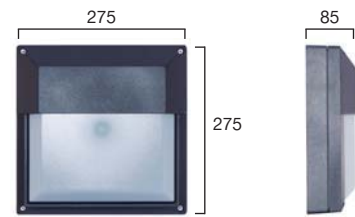
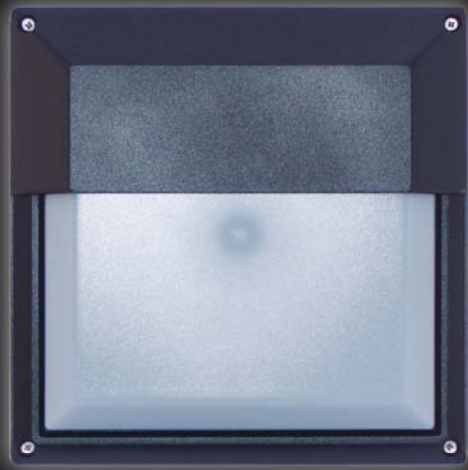

**WM-471**  
E27 GENIE 18W  
2,000.-

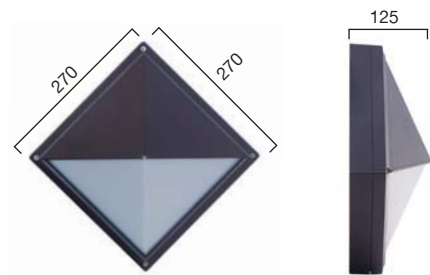

**WM-491**  
E27 GENIE 18W  
2,000.-

Material : Aluminum, Acrylic  
Voltage : 220-240V 50Hz  
110-130V 60Hz

# WM SERIES

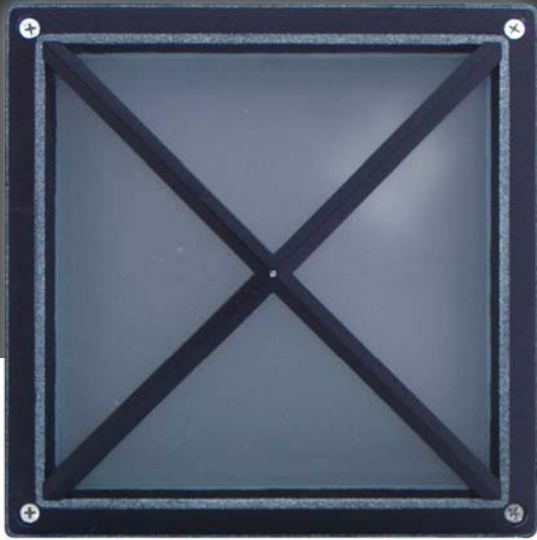

## WM-S00

E27 GENIE 14W

1,400.-

## WM-S01

E27 GENIE 18W

1,800.-



Material : Aluminum, Glass  
Voltage : 220-240V 50Hz  
110-130V 60Hz

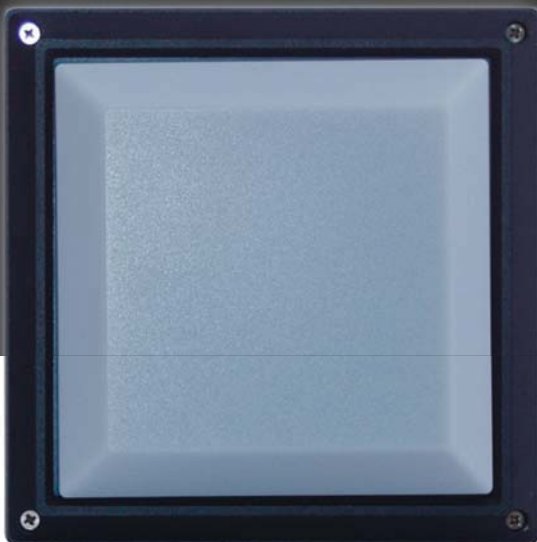

## WM-S10

E27 GENIE 14W

1,400.-

## WM-S11

E27 GENIE 18W

1,800.-



Material : Aluminum, Acrylic  
Voltage : 220-240V 50Hz  
110-130V 60Hz



# WM SERIES



## WM-S20

E27 GENIE 14W

1,800.-

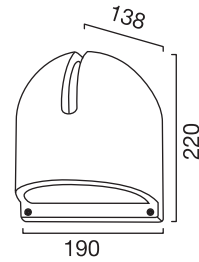

## WM-S30

G9 220V 50W

G9 LED 3W

1,600.-

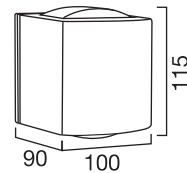

## WM-S40

G9 220V 50W

G9 LED 3W

1,800.-

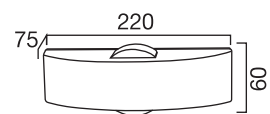

Material : Aluminum, Glass  
Voltage : 220-240V 50Hz  
110-130V 60Hz

# WM SERIES



**WM-SS01**  
E27 GENIE 18W  
1,100.-



**WM-SS02**  
E27 GENIE 18W  
1,100.-



**WM-SS03**  
E27 GENIE 18W  
1,100.-

Material : Aluminum, Acrylic  
Voltage : 220-240V 50Hz  
110-130V 60Hz

WM-S61

E27 GENIE 18W

1,600.-

WM-S62

E27 GENIE 18W

1,600.-

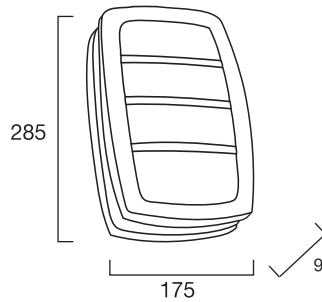
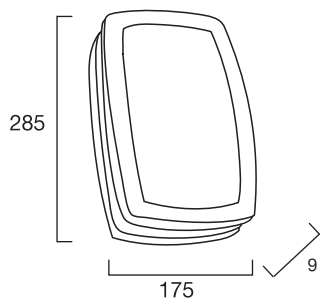

Material : Aluminum, Acrylic  
Voltage : 220-240V 50Hz  
110-130V 60Hz

# WM SERIES

## WM-S70

E27 GENIE 18W

1,400.-

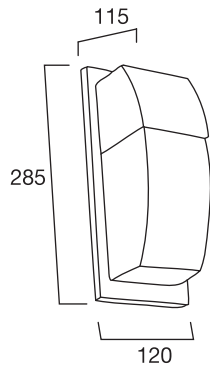

## WM-S80

E27 GENIE 18W

1,400.-



## WM-S71

E27 GENIE 18W

1,400.-

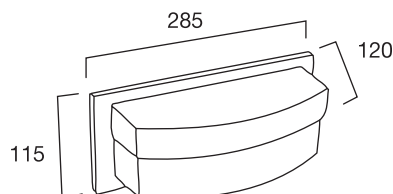

Material : Aluminum, Acrylic  
Voltage : 220-240V 50Hz  
110-130V 60Hz



WM-590

E27 Genie 18W

1,540.-

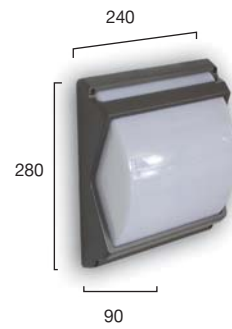

WM-600

E27 GENIE 18W

1,540.-

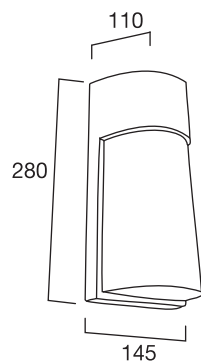

# WM SERIES

**WM-610**

E27 GENIE 18W

1,630.-

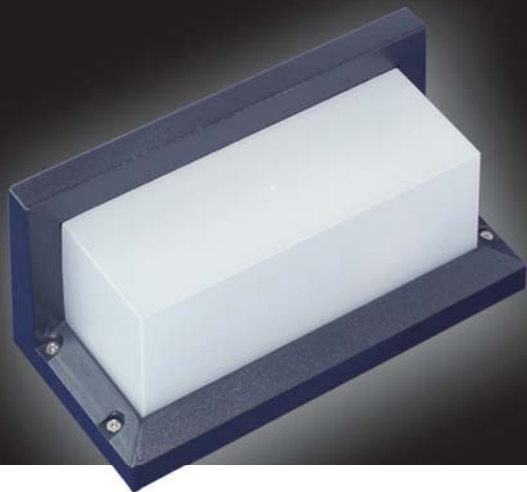

**WM-611**

E27 GENIE 18W

1,870.-

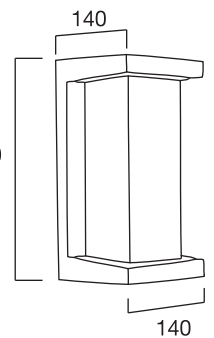
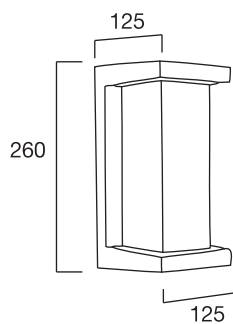
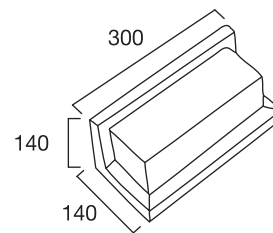
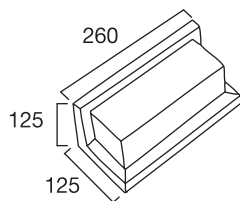
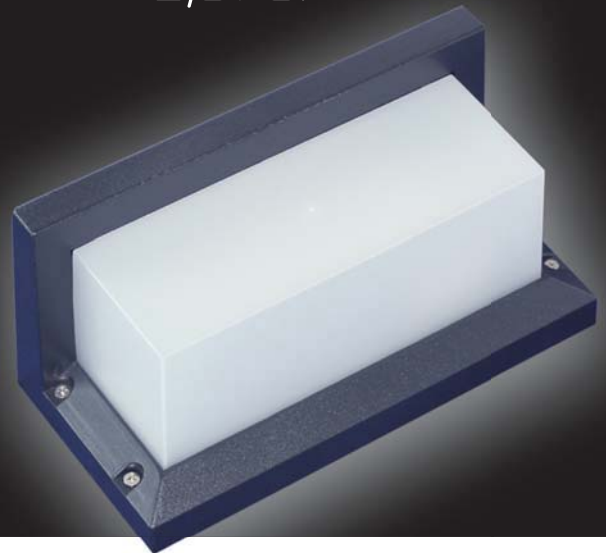

**WM-620**

E27 GENIE 18W

1,630.-

**WM-621**

E27 GENIE 18W

1,870.-

Material : Aluminum, Acrylic  
Voltage : 220-240V 50Hz  
110-130V 60Hz

WM-631

E27 GENIE 18W

1,870.-

WM-630

E27 GENIE 18W

1,630.-

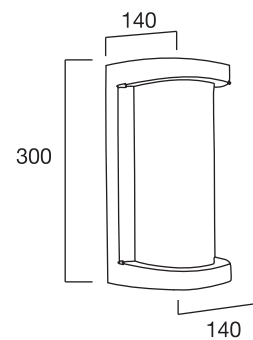
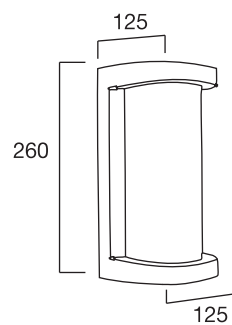

Material : Aluminum, Acrylic  
Voltage : 220-240V 50Hz  
110-130V 60Hz

# WM SERIES

## WM-650

E27 GENIE 18W

1,440.-



## WM-660

E27 GENIE 18W

1,440.-

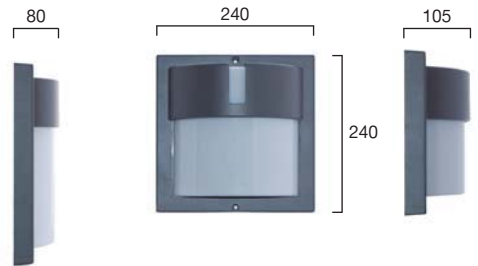

## WM-670

E27 GENIE 11W

1,680.-

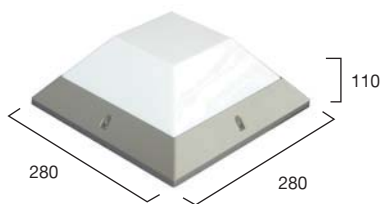

## WM-680

E27 GENIE 11W

800.-



Material : Aluminum, Acrylic  
Voltage : 220-240V 50Hz  
110-130V 60Hz



WM-690

E27 GENIE 11W

760.-



WM-700

E27 GENIE 11W

1,340.-

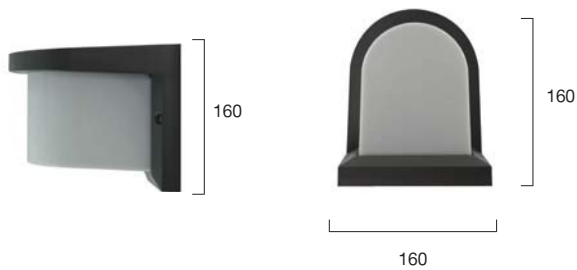

WM-710

E27 GENIE 11W

1,340.-

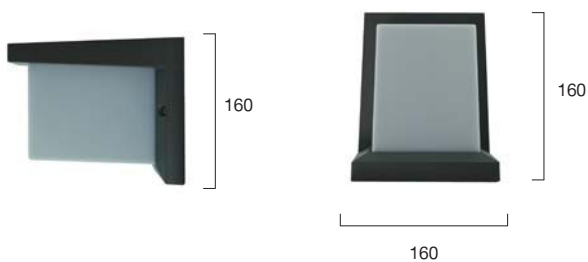

Material : Aluminum, Acrylic  
Voltage : 220-240V 50Hz  
110-130V 60Hz

# WM SERIES



**WM-720**  
E27x2 GENIE 14W  
1,320.-

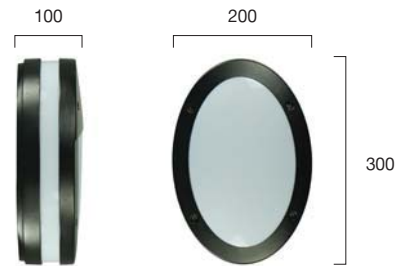

**WM-730**  
E27x2 GENIE 14W  
1,320.-

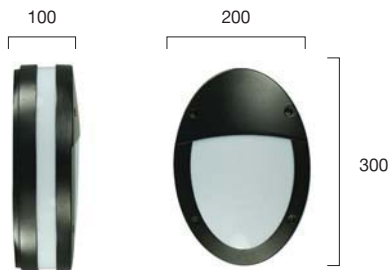

Material : Aluminum  
Voltage : 220-240V 50Hz  
110-130V 60Hz

# WM SERIES

## WM-740

E27x2 GENIE 14W

1,320.-

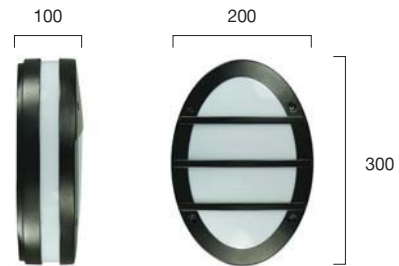

## WM-750

E27x2 GENIE 14W

1,320.-

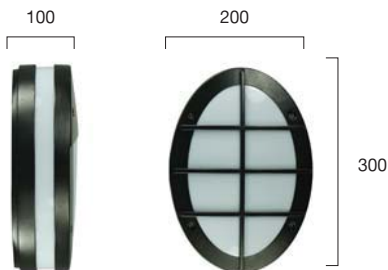

Material : Aluminum  
Voltage : 220-240V 50Hz  
110-130V 60Hz

# WM SERIES



**WM-760**

E27x2 GENIE 14W

1,800.-



**WM-770**

E27 TORNADO 24W

2,000.-

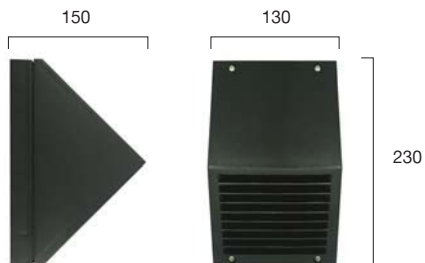

Material : Aluminum  
Voltage : 220-240V 50Hz  
110-130V 60Hz

# WM SERIES

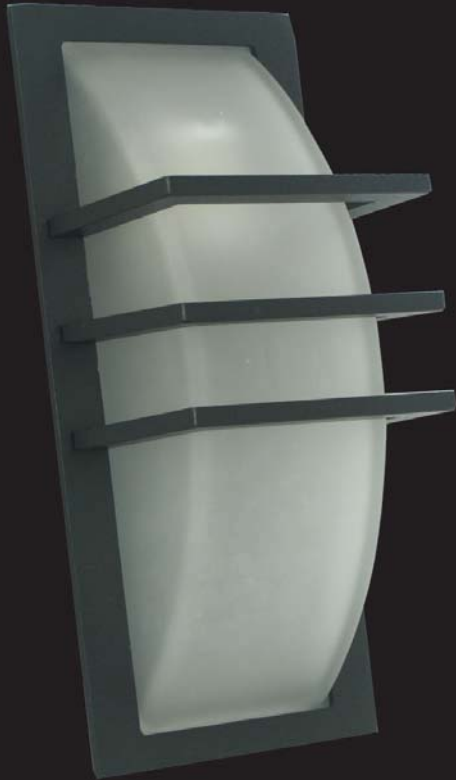

## WM-2815

E27 Genie 14W

1,200.-

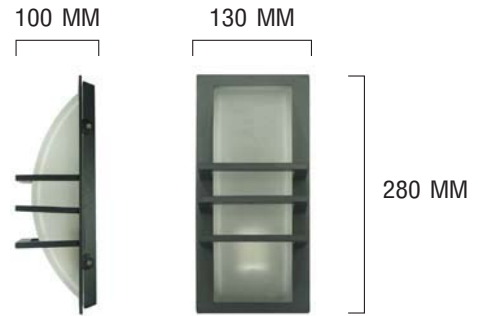

## WM-2805

E27 Genie 14W

1,200.-

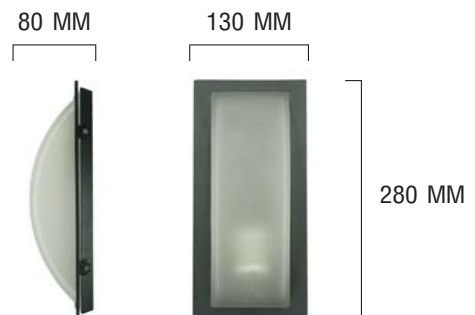

Material : Aluminum  
Voltage : 220-240V 50Hz  
110-130V 60Hz

# WM SERIES



## WM-2905

E27 Genie 14W

1,200.-

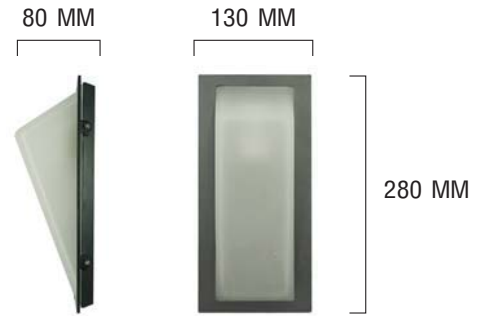

## WM-2915

E27 Genie 14W

1,200.-

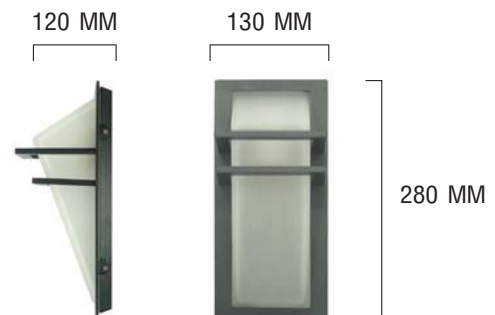

# STEP SERIES



## STEP-110

G9 220V SOW

G9 LED 3W

1,200.-

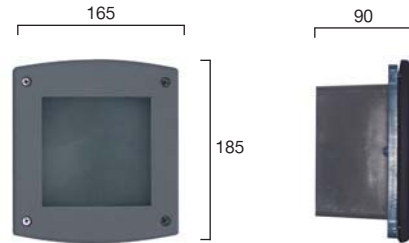

## STEP-120

G9 220V SOW

G9 LED 3W

1,200.-

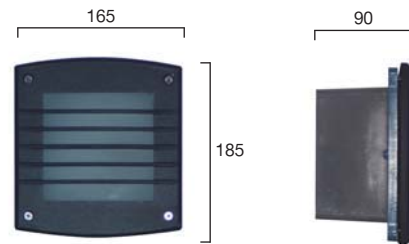

## STEP-130

G9 220V SOW

G9 LED 3W

1,200.-

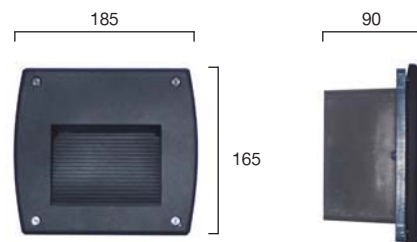

Material : Aluminum, Glass  
Voltage : 220-240V 50Hz  
110-130V 60Hz

# STEP SERIES

## STEP-140

E27 GENIE 11W  
G24 PLC 18W  
900.-

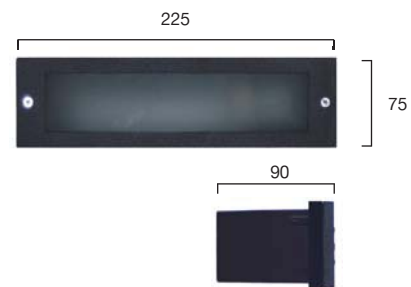

## STEP-150

E27 GENIE 11W  
G24 PLC 18W  
900.-

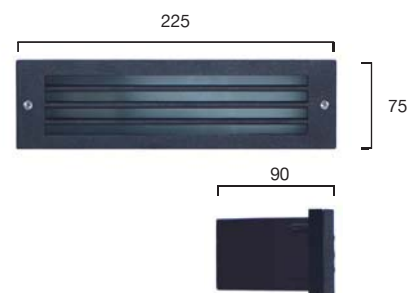

## STEP-160

E27 GENIE 11W  
G24 PLC 18W  
900.-

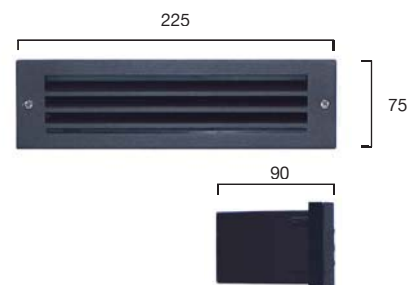

Material : Aluminum  
Voltage : 220-240V 50Hz  
110-130V 60Hz



# STEP SERIES

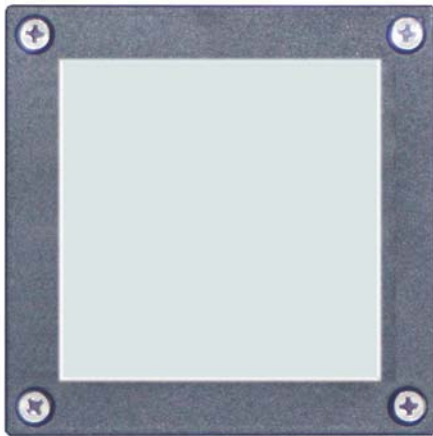

**STEP-170**  
G9 220V 50W  
G9 LED 3W  
1,440.-

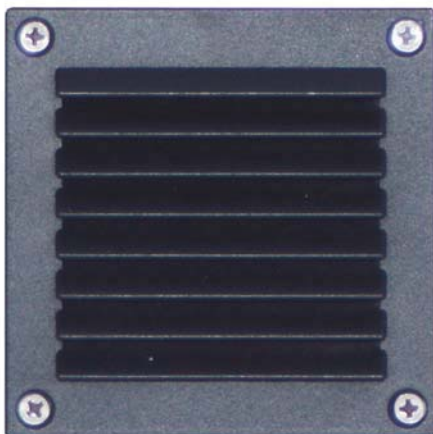
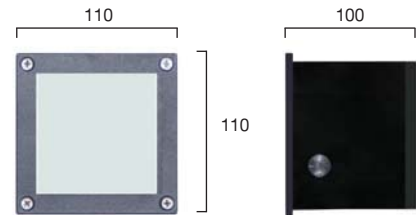

**STEP-180**  
G9 220V 50W  
G9 LED 3W  
1,440.-

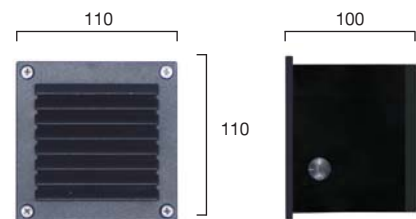

**STEP-190**  
G9 220V 50W  
G9 LED 3W  
1,440.-

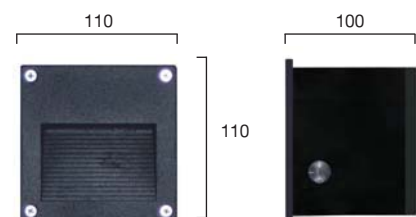

Material : Aluminum  
Voltage : 220-240V 50Hz  
110-130V 60Hz

# STEP SERIES



## STEP-200

E27 GENIE 11W

700.-

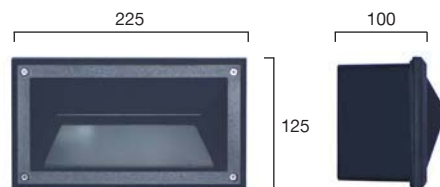

## STEP-210

E27 GENIE 11W

700.-

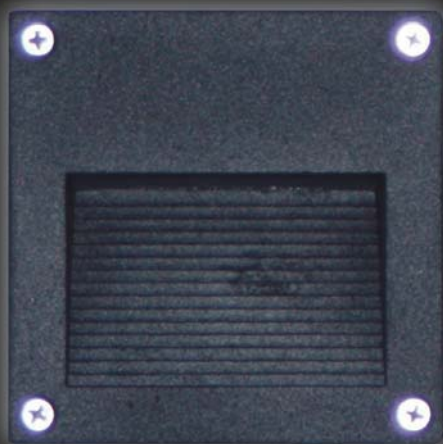
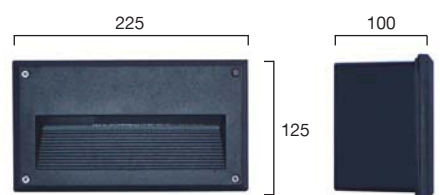

## STEP-220

GS.3 MAX 50W

1,500.-

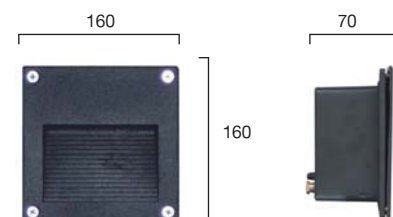

Material : Aluminum  
Voltage : 220-240V 50Hz  
110-130V 60Hz

## STEP-230

G9 220V 50W

G9 LED 3W

1,000.-

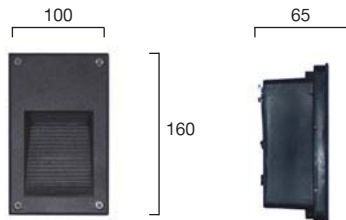

## STEP-240

G5.3 MAX 50W

1,000.-

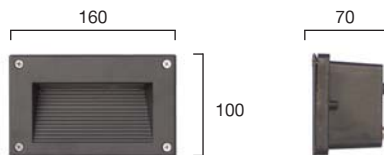

## STEP-250

E27 GENIE 18W

G24 TCD 26W

1,800.-

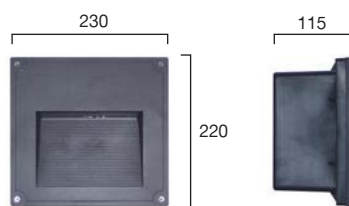

Material : Aluminum  
Voltage : 220-240V 50Hz  
110-130V 60Hz

# STEP SERIES

## STEP-260/LED

LED 220V SW (3000K)

2,200.- (พร้อมหลอด)

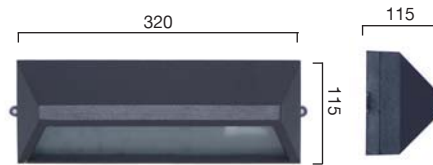
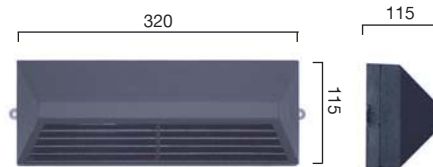
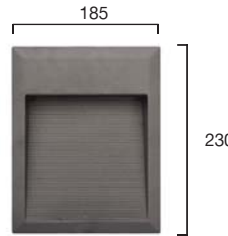

## STEP-270

E27 GENIE 18W

G24D TCD 26W

1,800.-



## STEP-280

E27 GENIE 18W

G24D TCD 26W

1,800.-



Material : Aluminum  
Voltage : 220-240V 50Hz  
110-130V 60Hz

# STEP SERIES

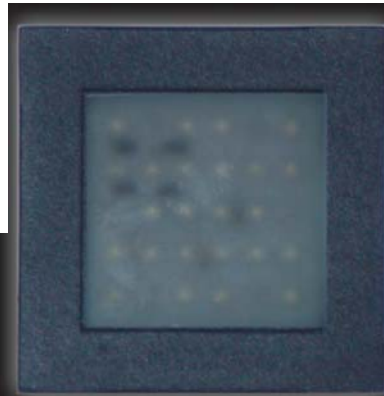
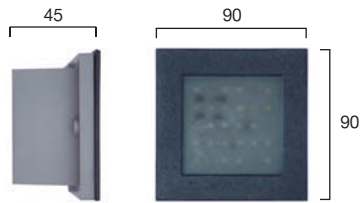

## STEP-290/LED

LED 220V 3W 3000K

1,500.-

(តម្រូវការសម្រាប់ដំឡើង LED)

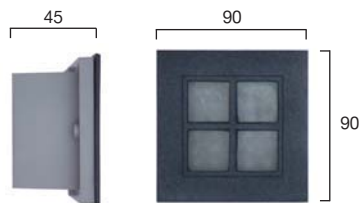

## STEP-300/LED

LED 220V 3W 3000K

1,500.-

(តម្រូវការសម្រាប់ដំឡើង LED)

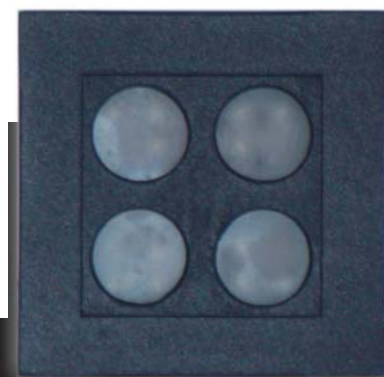
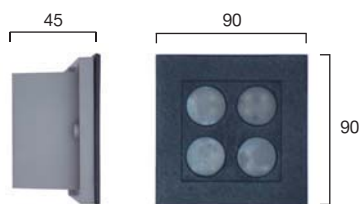

## STEP-310/LED

LED 220V 3W 3000K

1,500.-

(តម្រូវការសម្រាប់ដំឡើង LED)

Material : Aluminum  
Voltage : 220-240V 50Hz  
110-130V 60Hz

TEL. 034-872577 FAX 034-872566

STEP-7

# STEP SERIES

## STEP-330/LED

LED 220V 1.4W  
(6500K, 3000K)  
(BL, GN, RD)

3,500.-

(ราคาพร้อมชุดพรีอ Driver)



## STEP-320

G23 PLS 9W

1,850.-

(พร้อมบัลลาสต์ 9W)

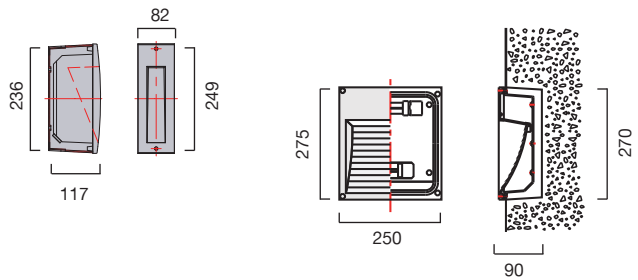
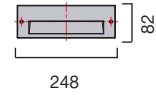
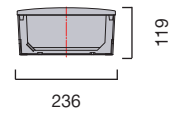

## STEP-340

G24 PLC 26W

4,400.-

(ราคาพร้อมบัลลาสต์ 26W)



Material : Aluminum  
Voltage : 220-240V 50Hz  
110-130V 60Hz

# STEP SERIES

## STEP-350

LED 220V 1.4W

1,760.- (ราคาพร้อมหลอดยังไม่รวม Driver)

## STEP-360

LED 220V 1.4W

1,760.- (ราคาพร้อมหลอดยังไม่รวม Driver)

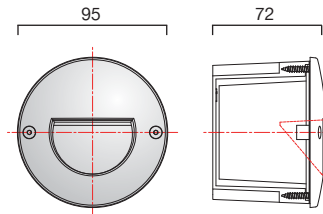
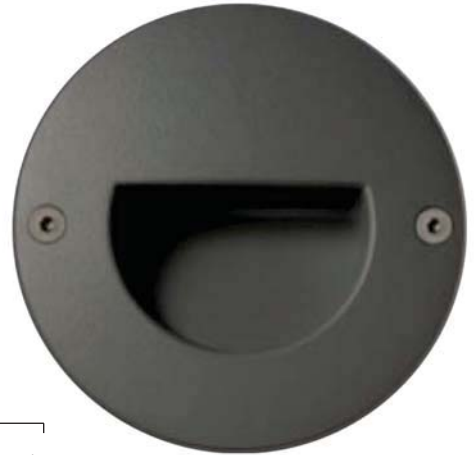
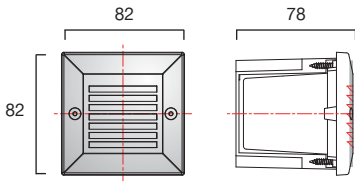

## STEP-370

LED 220V 1.4W

1,760.- (ราคาพร้อมหลอดยังไม่รวม Driver)

## STEP-380

LED 220V 1.4W

1,760.- (ราคาพร้อมหลอดยังไม่รวม Driver)

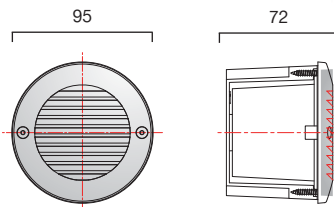
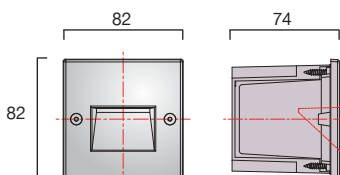

Driver LED 350 MA 1,080.-

(แสง LED 3000K, 6500K, BL, GN, RD เลือกได้)

Material : Die-cast Aluminum  
Voltage : 220-240V 50Hz  
110-130V 60Hz

# LED SERIES

## LED-11

LED 220V 1.4W 3000K

1,200.-

(ราคาครบชุดพร้อม LED)



## LED-12

LED 220V 1.4W 3000K

1,200.-

(ราคาครบชุดพร้อม LED)

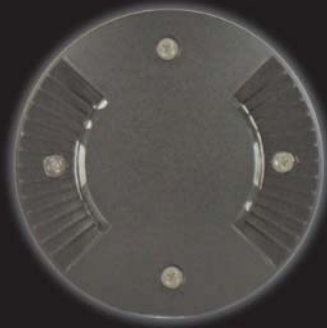

## LED-13

LED 220V 1.4W 3000K

1,200.-

(ราคาครบชุดพร้อม LED)

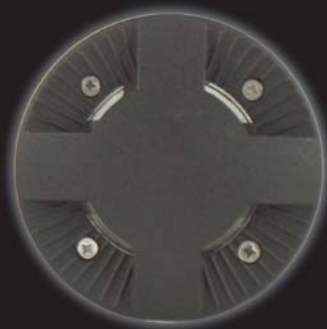

## LED-18

LED 220V 1.4W 3000K

1,300.-

(ราคาครบชุดพร้อม LED)

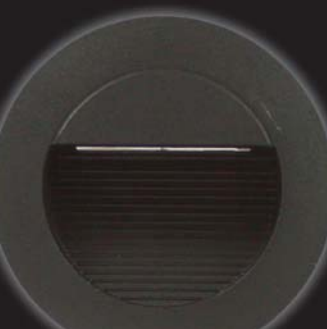

Material : Aluminum  
Voltage : 220-240V 50Hz  
110-130V 60Hz



# LED SERIES

## LED-14

LED 220V 1.4W 3000K

1,400.-

(ราคาครอบคลุมพร้อม LED)



## LED-15

LED 220V 1.4W 3000K

1,400.-

(ราคาครอบคลุมพร้อม LED)

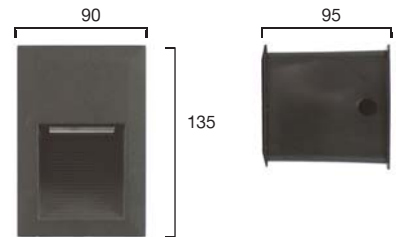

## LED-16

LED 220V 1.4W 3000K

1,400.-

(ราคาครอบคลุมพร้อม LED)

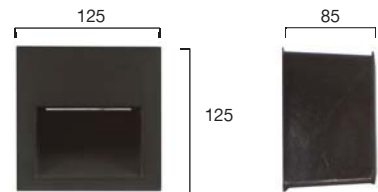
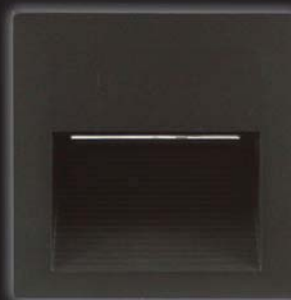

## LED-17

LED 220V 1.4W 3000K

1,400.-

(ราคาครอบคลุมพร้อม LED)

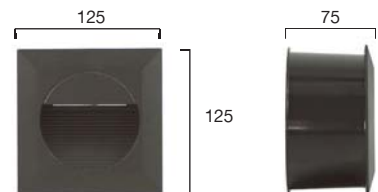

Material : Aluminum  
Voltage : 220-240V 50Hz  
110-130V 60Hz

# LED SERIES

## LED-19

LED 220V 1.4W 350MA

2,800.- (ราคาพร้อมหลอดไม่รวม Driver)

## LED-19/G4

G4 12V 10W

2,300.-

(พร้อมหลอด 12V 10W ไม่รวมหม้อแปลง)

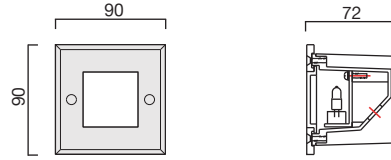

## LED-20

LED 220V 1.4W 350MA

2,800.- (ราคาพร้อมหลอดไม่รวม Driver)

## LED-20/G4

G4 12V 10W

2,300.-

(พร้อมหลอด 12V 10W ไม่รวมหม้อแปลง)

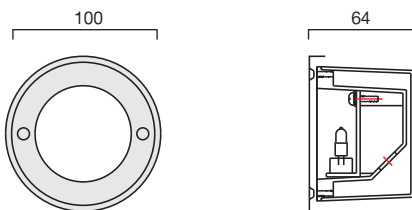

Driver LED 350MA 1,080.-

Material : STAINLESS 316 -GLASS  
ใช้ระบบโถงใส่  
Voltage : 220-240V 50Hz  
110-130V 60Hz

# LED SERIES



LED-LP38I18W/DIM(100)-15  
2,500.-



LED-LP38I18W/DIM(100)-40  
2,500.-



Power : 18W  
Lamp base : E27  
CCT : 3000K  
Lens angle : 15°  
Input Voltage : AC 220V  
Lifetime : 40,000 hr  
Lumen Flux : 900 lm



Power : 18W  
Lamp base : E27  
CCT : 3000K  
Lens angle : 40°  
Input Voltage : AC 220V  
Lifetime : 40,000 hr  
Lumen Flux : 900 lm

# LED SERIES



Power : 12W  
Lamp base : E27  
CCT : 3000K  
Lens angle : 8°  
Input Voltage : AC 220V  
Lifetime : 40,000 hr  
Lumen Flux : 600 lm



LED-LP30I12W/DIM(7S)-8  
1,700.-



Power : 12W  
Lamp base : E27  
CCT : 3000K  
Lens angle : 40°  
Input Voltage : AC 220V  
Lifetime : 40,000 hr  
Lumen Flux : 600 lm



LED-LP30I12W/DIM(7S)-40  
1,700.-

# LED SERIES



LED-LQR22012W/DIM-8  
2,000.- (រៀបចំឆែត)



Power : 12W  
Lamp base : GX53  
CCT : 3000K  
Lens angle : 8°  
Input Voltage : AC 220V  
(ប្រើប្រាស់ Driver)  
Lifetime : 40,000 hr  
Lumen Flux : 720 lm



LED-LQR22012W/DIM-25  
2,000.- (រៀបចំឆែត)



Power : 12W  
Lamp base : GX53  
CCT : 3000K  
Lens angle : 25°  
Input Voltage : AC 220V  
(ប្រើប្រាស់ Driver)  
Lifetime : 40,000 hr  
Lumen Flux : 720 lm

# LED SERIES



Power : 12W  
Lamp base : GX53  
CCT : 3000K  
Lens angle : 8°  
Input Voltage : 12V  
(ควบคุมแสง  
12โวลต์ทั่วไป)  
Lifetime : 40,000 hr  
Lumen Flux : 720 lm



LED-LQR1212W-8

1,500.-



Power : 12W  
Lamp base : GX53  
CCT : 3000K  
Lens angle : 25°  
Input Voltage : 12V  
(ควบคุมแสง  
12โวลต์ทั่วไป)  
Lifetime : 40,000 hr  
Lumen Flux : 720 lm



LED-LQR1212W-25

1,500.-

# LED SERIES

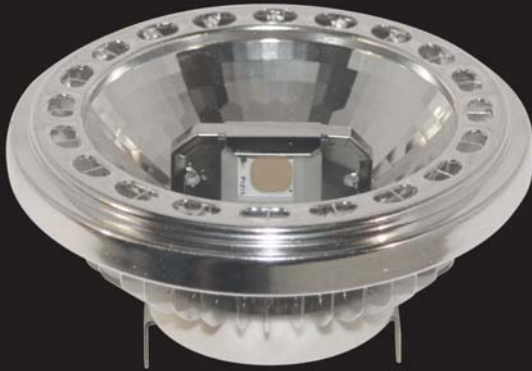

LED-LQR1215W-2S  
1,560.-



Power : 15W  
Lamp base : GX53  
CCT : 3000K  
Lens angle : 25°  
Input Voltage : 12V  
(កម្ពុជាបាយ  
12វ៉ុលតាមកែវ) )  
Lifetime : 40,000 hr  
Lumen Flux : 810 lm



LED-LQR22015W/DIM-2S  
2,200.- (ឆ្របតែតែតែត)



Power : 15W  
Lamp base : GX53  
CCT : 3000K  
Lens angle : 25°  
Input Voltage : AC 220V  
(ប្រើប្រាស់ Driver)  
Lifetime : 40,000 hr  
Lumen Flux : 810 lm

# LED SERIES



Power : 3W  
Lamp base : E14  
CCT : 3000K  
Input Voltage : AC 220V  
Lifetime : 40,000 hr  
Lumen Flux : 260 lm



LED-LJS3W/DIM(1S)

840.-



Power : 3W  
Lamp base : E14  
CCT : 3000K  
Input Voltage : AC 220V  
Lifetime : 40,000 hr  
Lumen Flux : 260 lm



LED-LJP3W/DIM(1S)

800.-



# LED SERIES



LED-LGU10SW/DIM(S0)-25  
900.-



LED-LGU10SW/DIM(S0)-40  
900.-



Power : 5W  
Lamp base : Gu10  
CCT : 3000K  
Lens angle : 25°  
Input Voltage : AC 220V  
Triac Dimmer : AC110V/220V  
Lifetime : 40,000 hr  
Lumen Flux : 350 lm



Power : 5W  
Lamp base : Gu10  
CCT : 3000K  
Lens angle : 40°  
Input Voltage : AC 220V  
Triac Dimmer : AC110V/220V  
Lifetime : 40,000 hr  
Lumen Flux : 350 lm

# LED SERIES



Power : 2W (CREE)  
Lamp base : G4  
CCT : 3000K  
Input Voltage : 12 V  
Lifetime : 40,000 hr



LED-LG4.122W(10)  
600.-



Power : 3W  
Lamp base : G9  
CCT : 3000K  
Input Voltage : AC 220V  
Lifetime : 40,000 hr



LED-LG93W  
600.-

# LED SERIES

## LED-LA600/GT

Power : 7W  
 Lamp base : E27  
 CCT : 3000K, 6500K  
 Input : 220V  
 Lifetime : 25000Hr.  
 Lumen Flux : 500 lm (3000K)  
 550 lm (6500K)  
 300.-



ບອນ. 1955-2551

## LED-LHA126C/LT-24

## LED-LHA126W/LT-24

Power : 6W  
 Lamp base : GUS.3  
 CCT : 3000K(W), 4200K  
 Input : 12V  
 (ໜ້ອຍແລະ 12 ຕາຊົ່ວໄປ)  
 Lifetime : 50000 Hr.  
 Lumen Flux : 390 lm (3000K)  
 415 lm (4200K)  
 600.-



## LED-LHA125W/GT

Power : 5W  
 Lamp base : GUS.3  
 CCT : 3000K(W)  
 Input : 12V  
 (ໜ້ອຍແລະ 12 ຕາຊົ່ວໄປ)  
 Lifetime : 25000 Hr.  
 Lumen Flux : 330 lm (3000K)  
 500.-



ບອນ. 1955-2551

## RIBBON Series SMD5050 DC 12V 60 leds/m

MODEL : LED-RB60

Chip : 5050 (3-in-1 Chip or RGB Chip)

Voltage : **DC 12V**

LED Quantity : **60 leds/m**

(Other requirements please contact us)

PCB Color : **White**

Color : Red, Green, Blue, Yellow, Daylight, Warm white, RGB

Cable Length : 15 cm (Can be customized)

LED Strip Length : 5 Meters/reel

Cuttable Length : can be cut every 3 pcs LEDs (DC 12V)

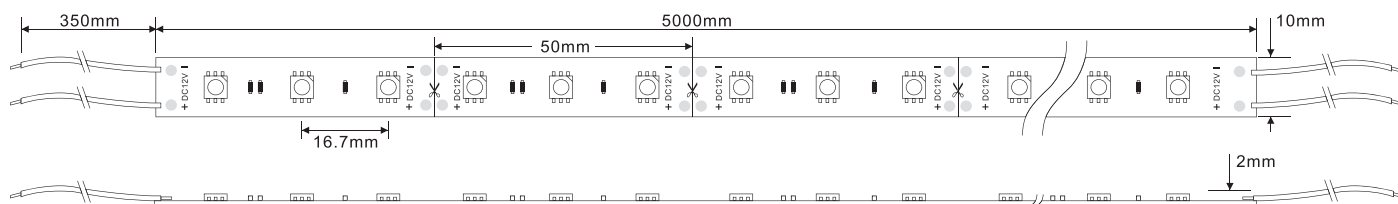

“✂” Said the cutting area. All LED's view angle is 120°.

Ribbon Series : SMD5050 60 leds/m							
Model number	Color	D/ (mm) 12V	LED Qty/meter	Lumen/meter	Voltage	Power/meter	Packing means
LED-RB60RGB/5050/20	Red	50	60	120	12V	MAX 14.4 W	5 meters/reel 150 g
	Green			240			
	Blue			150			
LED-RB60RD/5050/20	Red	50	60	360	12V	MAX 14.4 W	5 meters/reel 150 g
LED-RB60YW/5050/20	Yellow			360			
LED-RB60BL/5050/20	Blue			450			
LED-RB60GN/5050/20	Green			720			
LED-RB60D/5050/20	Daylight			600-960			
LED-RB60W/5050/20	Warm white			480-840			

## RIBBON Series SMD5050 DC 12V 60 leds/m

MODEL : LED-RB60

Chip : 5050 (3-in-1 Chip or RGB Chip)

Voltage : **DC 12V**

LED Quantity : 60 leds/m

(Other requirements please contact us)

PCB Color : **White**

Color : Red, Green, Blue, Yellow, Daylight, Warm white, RGB

Wire Length : 15 cm (Can be customized)

LED Strip Length : 5 Meters/reel

Cuttable Length : can be cut every 3 pcs LEDs (DC 12V)

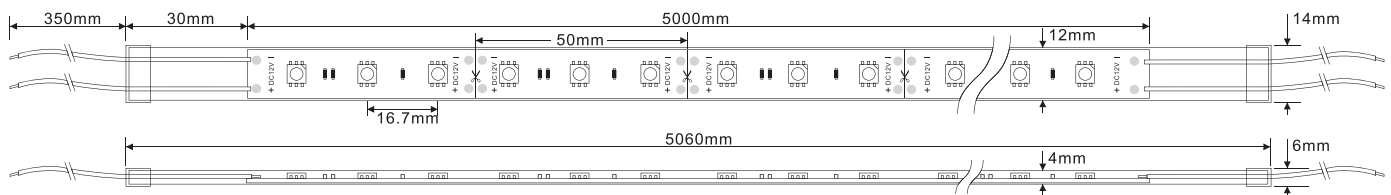
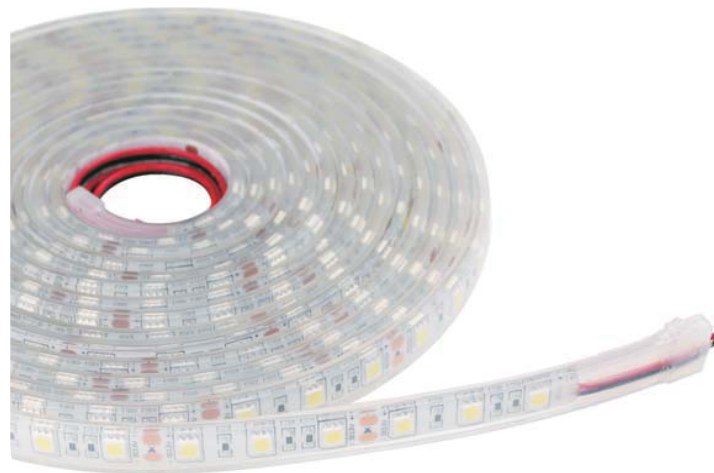

"X" said the cutting area. All LED's view angle is 120 degree.

RIBBON Series: 5050 60 leds/m							
Model number	Color	D/ (mm) 12V	LED Qty/ meter	Lumen/ meter	Voltage	Power/ meter	Packing means
LED-RB60RGB/5050/68	Red	50	60	120	12V	MAX 14.4 W	5.06 meters/ reel 450 g
	Green			240			
	Blue			150			
LED-RB60RD/5050/68	Red	50	60	360	12V	MAX 14.4 W	5.06 meters/ reel 450 g
LED-RB60YW/5050/68	Yellow			360			
LED-RB60BL/5050/68	Blue			450			
LED-RB60GN/5050/68	Green			720			
LED-RB60D/5050/68	Daylight			600-960			
LED-RB60W/5050/68	Warm white			480-840			

**RIBBON Series SMD5050 AC 220V leds/m**

**220V**

MODEL : LED-RBL60

Chip : 5050 (3-in-1 Chip or RGB Chip)

Voltage : **AC 220V**

LED Quantaity : **60 leds/m**

(Other requirements please contact us)

PCB Color : **White**

Color : Red, Green, Blue, Yellow, Daylight, Warm white, RGB

LED Strip Length : 100 Meters/reel

Cutttable Length : **can be cut every 1 Meters**

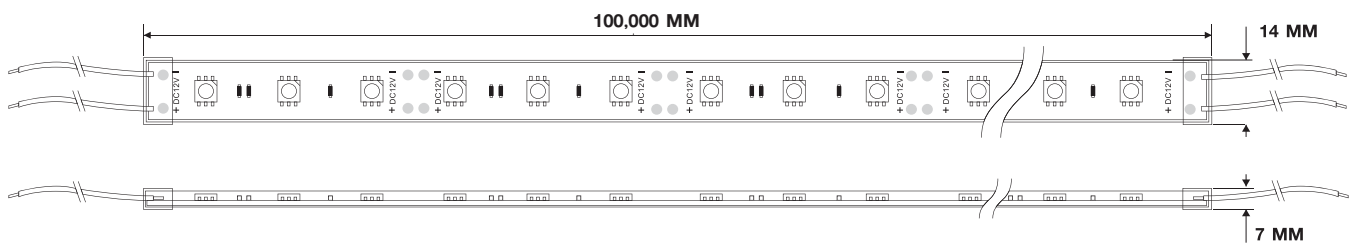

Diamond Series: 5050 60 leds/m							
Model number	Color	D/ (mm) 220 V	LED Qty/meter	Lumen/meter	Voltage	Power/meter	Packing means
LED-RBL60RGB/5050	Red	1000	60	120	220 V	MAX 14.4 W	
	Green			240			
	Blue			150			
LED-RBL60RD/5050	Red	1000	60	360	220 V	MAX 14.4 W	
LED-RBL60YW/5050	Yellow			360			
LED-RBL60BL/5050	Blue			450			
LED-RBL60GN/5050	Green			720			
LED-RBL60WH/5050	White			600~960			
LED-RBL60W/5050	Warm white			480~840			

■ How to cut and rejoin the LED strip:

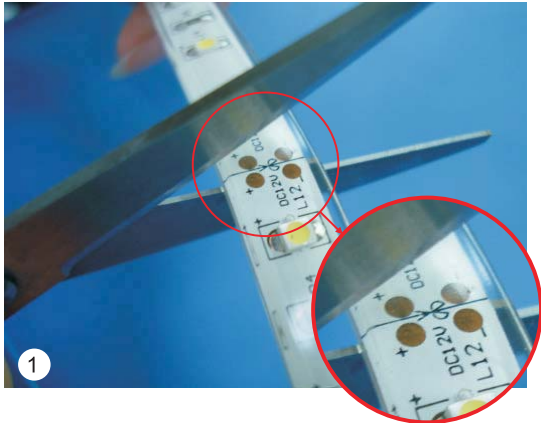

1. Please cut the LED strip at the cutting line.

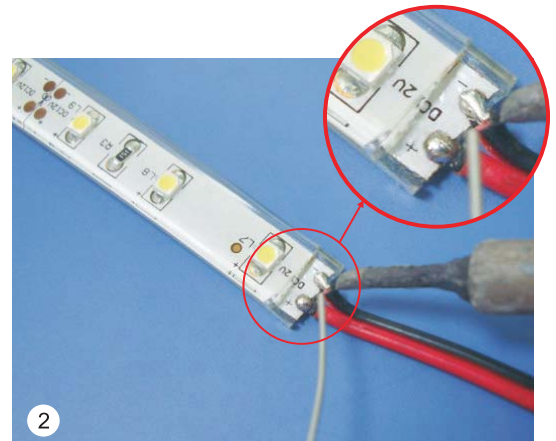

2. Rejoin the cables to the strip by soldering, please do not reverse the polarity.

LED-DIM-RF-2  
2,800.-



Contents

Technical SPEC (Controller)

- : RF 2.4 GHz
- : Dimmer
- : Wireless intuitive touch remote control
- : Effective Receiving distance nearly 30m
- Working voltage : DC12V 24V
- Output control : 1 circuit
- Control current : 6A/circuit
- Dimensions : 85x45x22 mm
- Receiving range : 30 meters

How to use

1. Use your finger to touch the color ring, you can change the brightness from the highest to the lowest (100%-1%, 50 grades to adjust).

2. Resume function. The previous settings will be resumed while power on again.

3. Matching code.

**Press** Key 3 once within 3 seconds when power on again, the light will blink 3 times if matching is successful.

**Clearing Code.**

**Press** key 3 five times within 3 seconds when power on again, the light will blink 6 times if clearing is successful.



Model	Price	Remark	Dimension
LED-TR1250/MW	1,400.-	12V DC 50W	129x98x38
LED-TR12100/MW	N/A	12V DC 100W	159x97x38
LED-TR12150/MW	N/A	12V DC 150W	199x98x38



รับประกัน 1 ปี

**Aluminium Series (5050 SMD LED)**

5050 RGB color type:

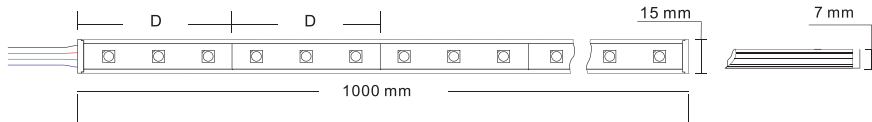

5050 Single color type:

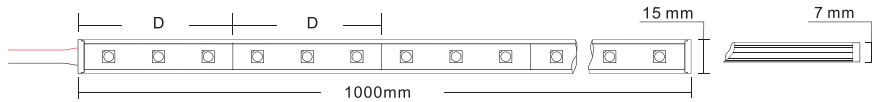

All LED's view angle is more than 120 degree

"D" is the minimum length you can get, you can get 1d, 2d, 3d .....

Aluminium series: 5050 60 LEDs/meter							Waterproof: IP65
Model number	Color	D/mm 12V	LED Qty/meter	Lumen/meter	Voltage	Power/meter	Weight
LED-BAR60RGB	Red	50	60	120	12V DC	14.4	140 g
	Green			240			
	Blue			150			
LED-BAR60RD	Red	50	60	360	12V DC	14.4	140 g
LED-BAR60YW	Yellow			360			
LED-BAR60GN	Blue			450			
LED-BAR60BL	Green			750			
LED-BAR60D	Daylight			960			
LED-BAR60W	Warm white			840			

LED-MODULE

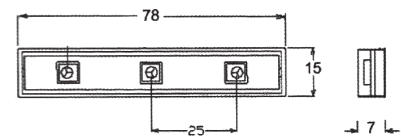

Model	Color	LED Qty/meter	Lumen/meter	Voltage	Power/meter
LED-MD3RGB	Red	30	60	12V DC	7.2
	Green		120		
	Blue		75		
LED-MD3RD	Red	30	180	12V DC	7.2
LED-MD3YW	Yellow		180		
LED-MD3BL	Blue		225		
LED-MD3GN	Green		375		
LED-MD3D	Daylight		480		
LED-MD3W	Warm white		420		



## How to connect the rigid bars

How to connect the single color strips to power supply. For the RGB type, Please refer to the "LED controller page".

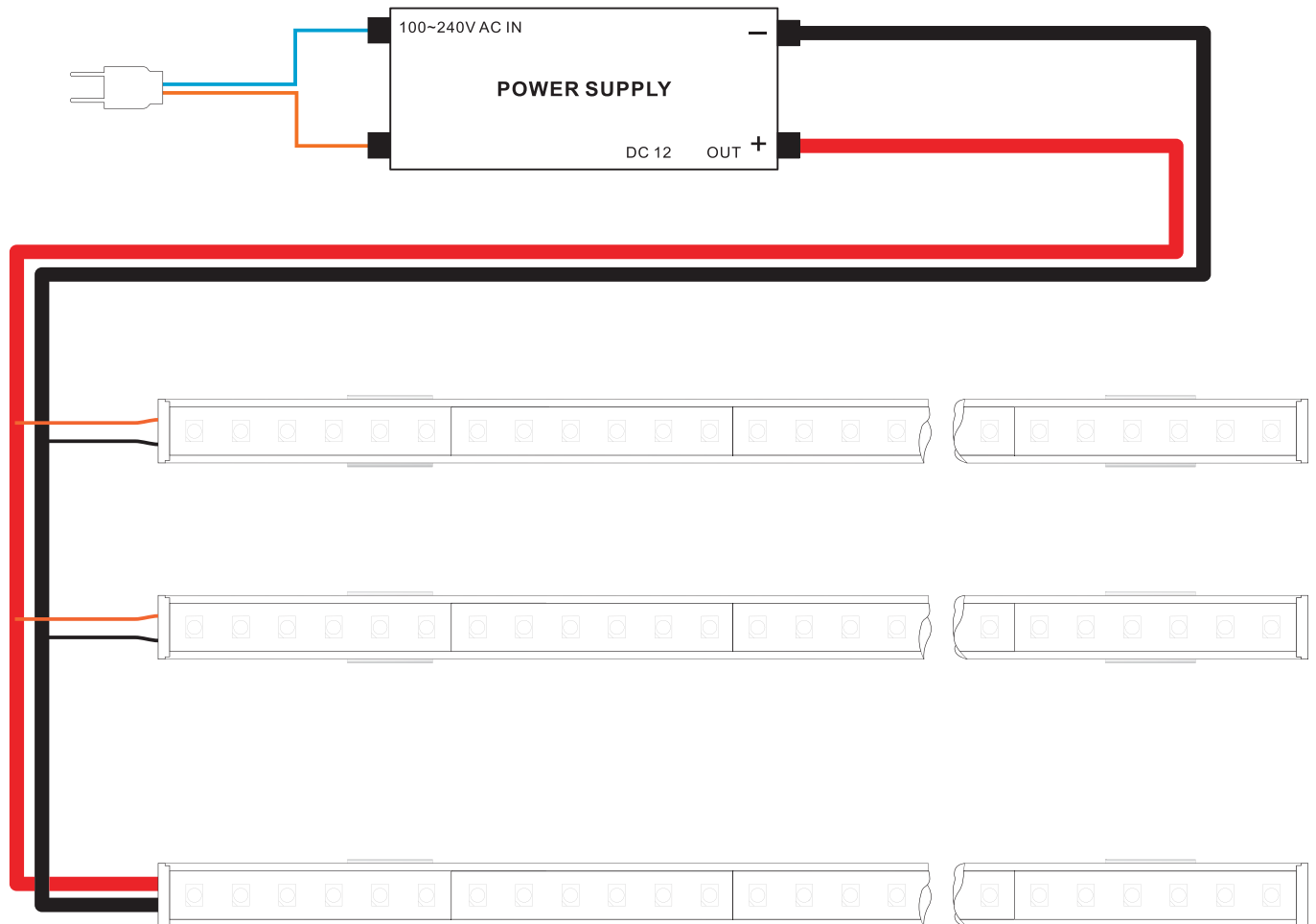

Side View

You also can use dimmer to adjust the brightness, please refer to

dimmer page.



This clip is used to fix the Bars

Model number: LD-RD-AL-CLIP



**LED WIFI control system**

**LED-CON-WIFI**

Working Platform : IOS System

Features :

As the Internet has become a global communication tool, intelligent control will also be part of the trend of the development of the society, which control software can be running on the apple IOS system. It is only necessary to open the software on your iPhone, and it can control the light at any time. Simple operation, easy to use, it is the ideal intelligent product.

**NEW**

**The product has the following characteristics**

1. Can be used in all kinds of lamps. Can control single lamp or multi lamps.
2. Networking support for routing mode and peer-to-peer mode, IEEE802.11 standards Protocol.
3. Can set the IP ADDRESS to the lamps, and switch freely between the routing mode and peer-to-peer. Adopting the TCP/IP Protocol information transmission.
4. Under the mode of scene lamps, You can compile the color you want, under the dimming mode, you can adjust the brightness.
5. set color for each day of a week and set mode or default color, and the control console will judge which day it is and show out the color you set.
6. With the power-off memory functions. It can memorize the status before power-off.

**LED-CONTROL-RF**

**RGB Remote Controller**

**RGB Manual Controller**

1,500.-

- Model Number : LED-CON-RF
- Working voltage : DC12-DC24V
- Rated Current : 8Ax3 CHANNEL
- Rated Power : 288W(DC12V), 576W(DC24V),
- Working Temperature : -20 - 60 °C
- Measurement : 120x62x24mm/112x65x24mm

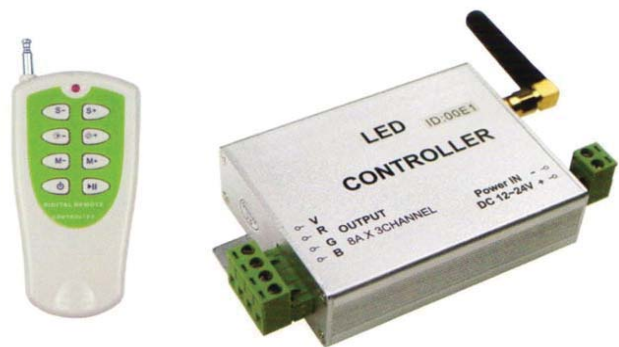

**RGB Remote Controller**

**120x62x24mm**



### LED-HL10W

LED 220V 10W 3000K

1,000.-

### LED-HL10D

LED 220V 10W 6000K

1,000.-

### LED-HL10RGB

LED 220V 10W MIX

1,400.- (with Remote included)

W88xH115mm



### LED-HL30W

LED 220V 30W 3000K

2,800.-

### LED-HL30D

LED 220V 30W 6000K

2,800.-

### LED-HL30RGB

LED 220V 30W MIX

3,800.- (with Remote included)

W190xH230mm



### LED-HLS0W

LED 220V 50W 3000K

4,000.-

### LED-HLS0D

LED 220V 50W 6000K

4,000.-

### LED-HLS0RGB

LED 220V 50W MIX

5,500.- (with Remote included)

W285xH235mm

# UP SERIES

UP-12020  
E27 PAR20 50W  
1,800.-

UP-11020  
E27 PAR20 50W  
1,300.-

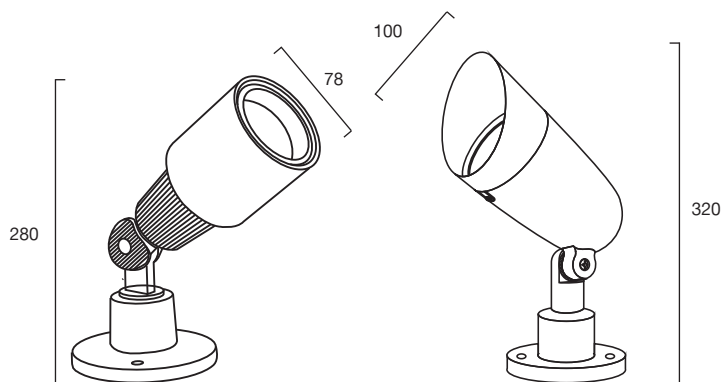
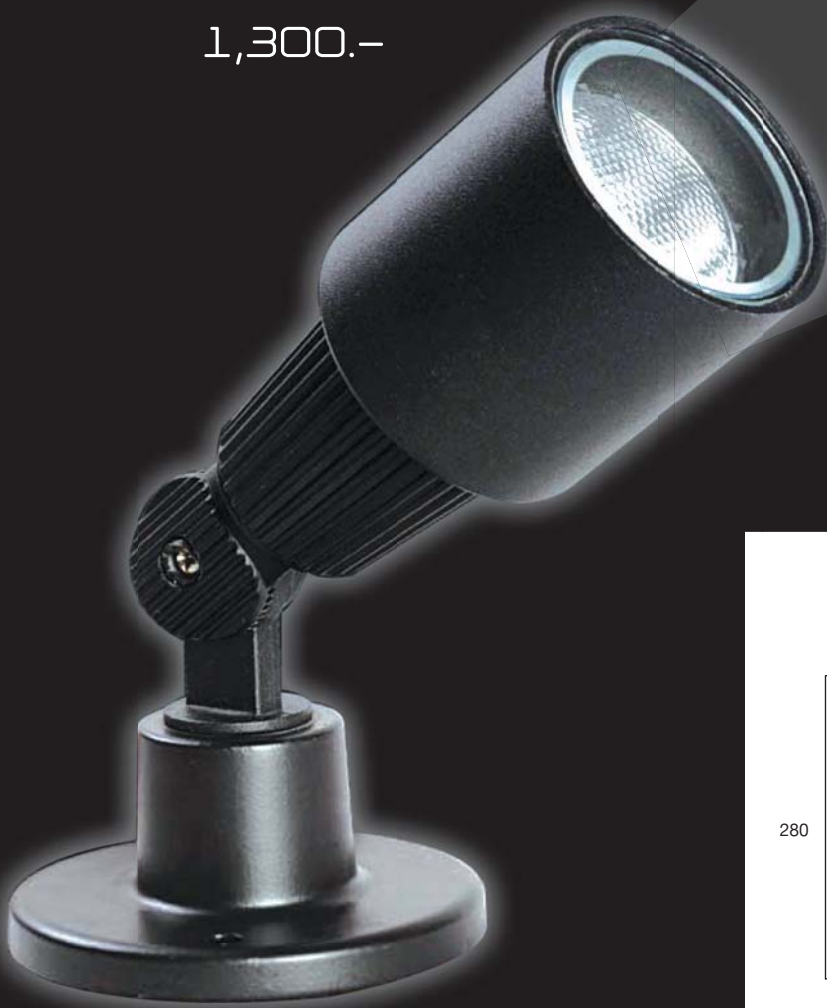

Material : Die-cast Aluminum  
Voltage : 220-240V 50Hz  
110-130V 60Hz

UP-13116  
MR16 12V SOW  
1,400.-

UP-13016  
MR16 12V SOW  
1,400.-

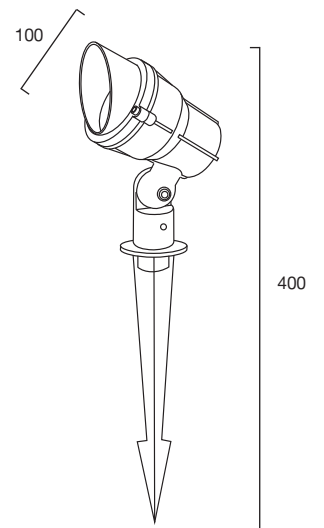
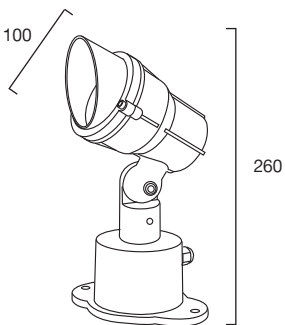

Material : Die-cast Aluminum  
Voltage : 12V

# UP SERIES

UP-14120  
E27 PAR20 SOW  
960.-



UP-14020  
E27 PAR20 SOW  
960.-



Material : Die-cast Aluminum  
Voltage : 220-240V 50Hz  
110-130V 60Hz



UP-15020  
E27 PAR20 SOW  
1,300.-



UP-15120  
E27 PAR20 SOW  
1,300.-

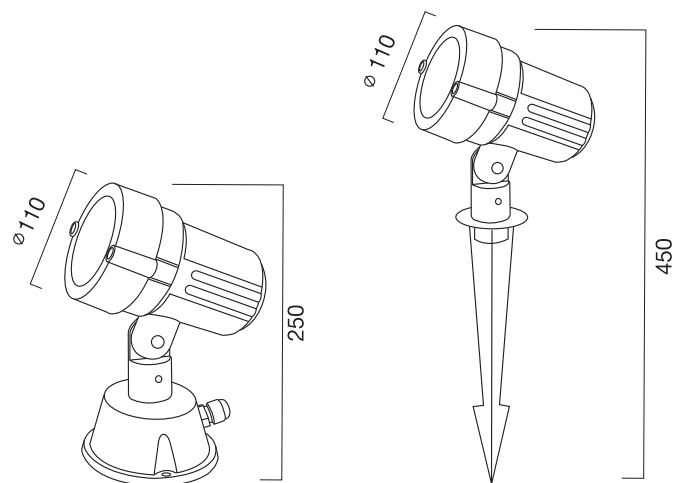

Material : Die-cast Aluminum  
Voltage : 220-240V 50Hz  
110-130V 60Hz

# UP SERIES

UP-16030

E27 PAR30 75W

1,700.-



UP-16130

E27 PAR30 75W

1,600.-

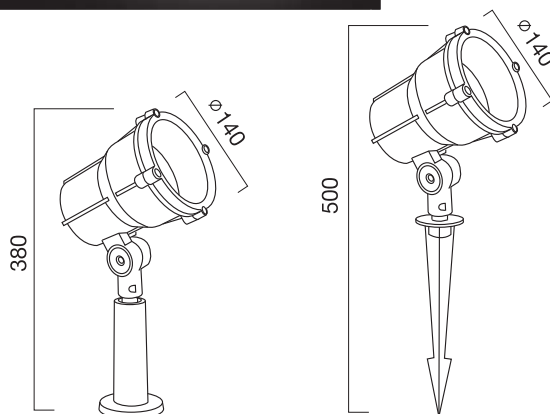

Material : Die-cast Aluminum  
Voltage : 220-240V 50Hz  
110-130V 60Hz





UP-17138

E27 PAR38 120W

1,300.-

UP-17038

E27 PAR38 120W

1,300.-

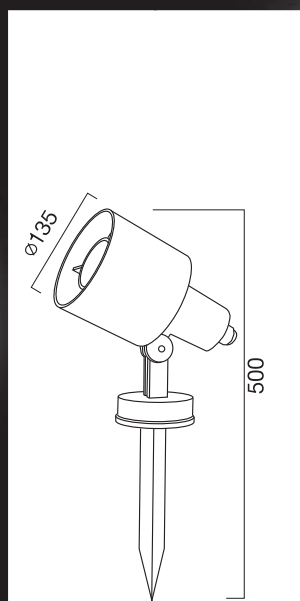
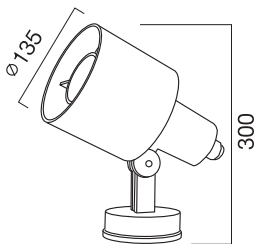

Material : Aluminum  
Voltage : 220-240V 50Hz  
110-130V 60Hz

TEL. 034-872577 FAX 034-872566

UP-6

# UP SERIES



**UP-18030**  
PAR30 100W  
1,600.-

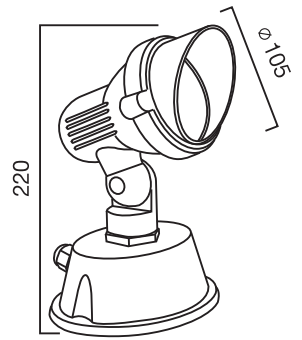
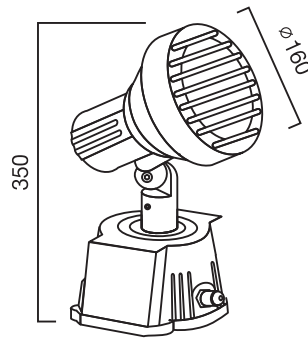

**UP-19012**  
G12 HIT-CE 70W  
3,000.-



**UP-23016**  
MR16 12V 50W  
980.-

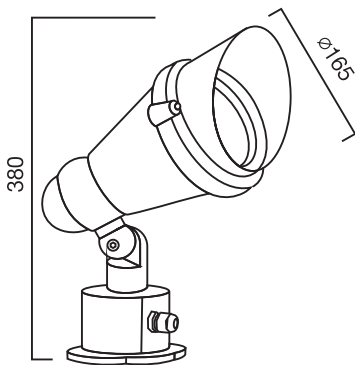

Material : Aluminum  
Voltage : 220-240V 50Hz  
110-130V 60Hz

UP-22138

E27 PAR38 120W

2,000.-



UP-21130

E27 PAR30 100W

1,600.-



UP-20138

E27 PAR38 120W

1,800.-

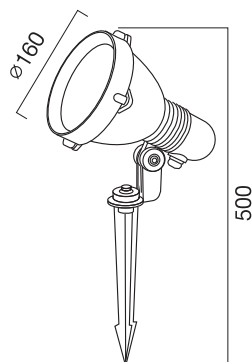
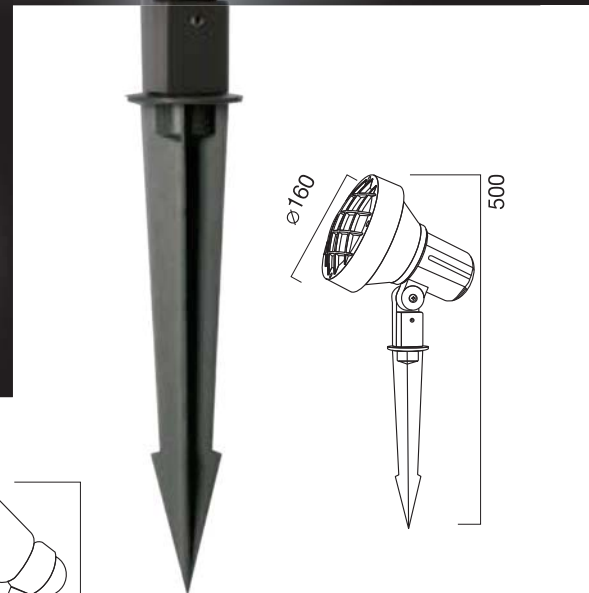

(มี Reflector ตำนโใบ)  
สามารถใส่หลอดประหยัดไฟได้

Material : Aluminum  
Voltage : 220-240V 50Hz  
110-130V 60Hz

# UP SERIES

UP-24012  
G12 HIT-CE70W  
3,000.-

UP-24138  
E27 PAR38 120W  
1,800.-

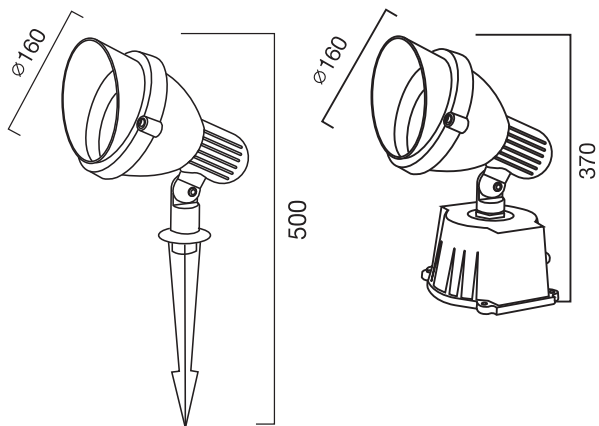

Material : Aluminum  
Voltage : 220-240V 50Hz  
110-130V 60Hz

UP-9 | LIGHTTRIO

UP SERIES

UP-25127

E27 TORNADO 24Wx2

2,600.-



UP-25027

E27 TORNADO 24Wx2

2,600.-

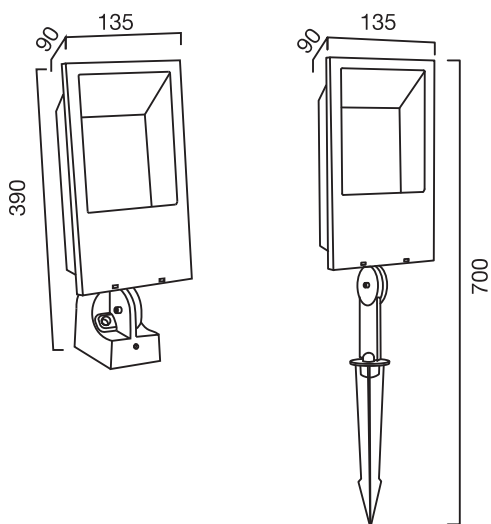

Material : Aluminum  
Voltage : 220-240V 50Hz  
110-130V 60Hz

TEL. 034-872577 FAX 034-872566

UP-10

# UP SERIES

UP-26016

MR16 12V 50W

4,000.-

(พร้อมหลอดแอลอีดี 12 V)



UP-27020

E27 PAR20 50W

2,820.-

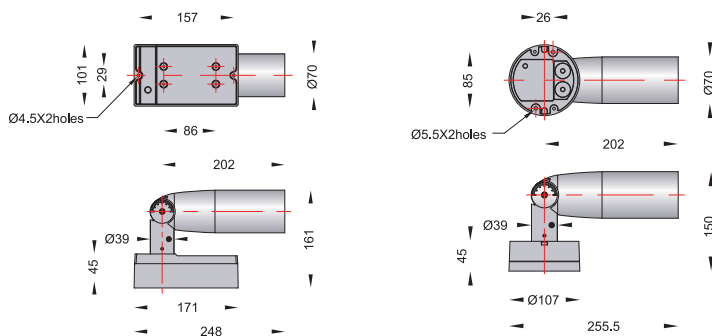

QR-CB51GU53 Par20 10°

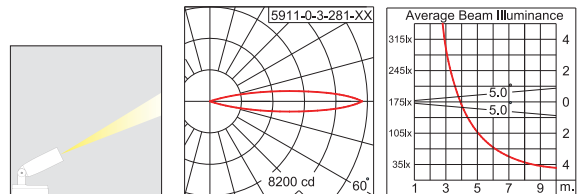

Material : Aluminum  
 Voltage : 220-240V 50Hz  
 110-130V 60Hz

# BOL SERIES



**BOL-1701**

E27 GENIE 18W

7,500.-

**BOL-1801**

E27 GENIE 18W

7,000.-

**BOL-2001**

E27 GENIE 18W

7,880.-

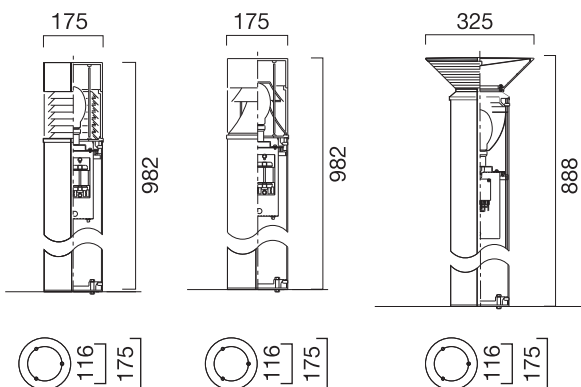

Material : Aluminum  
Voltage : 220-240V 50Hz  
110-130V 60Hz

TEL. 034-872577 FAX 034-872566

BOL-1



**BOL-1901**  
E27 GENIE 18W  
7,900.-



**BOL-1902**  
E27 GENIE 18W  
6,600.-



**BOL-2301**  
G24 PLC18W  
3,900.-

ราคาพร้อมบิลลาสต์ 18 วัตต์

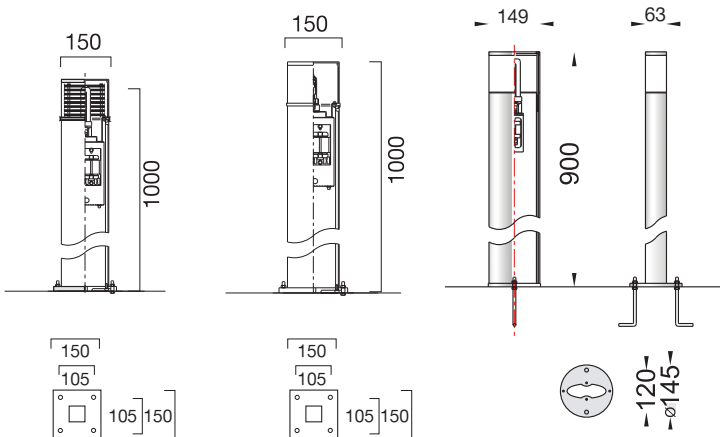

Material : Aluminum  
Voltage : 220-240V 50Hz  
110-130V 60Hz



# BOL SERIES



**BOL-2101**  
E27 GENIE 18W  
4,000.-

**BOL-2102**  
E27 GENIE 18W  
4,000.-

**BOL-2103**  
E27 GENIE 18W  
4,000.-

**BOL-2104**  
E27 GENIE 18Wx2  
6,500.-

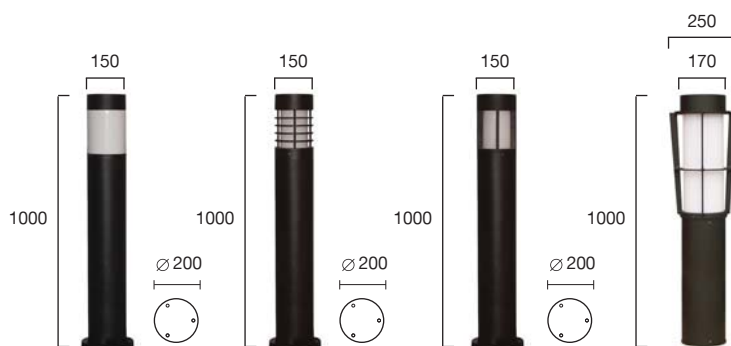

# BOL SERIES

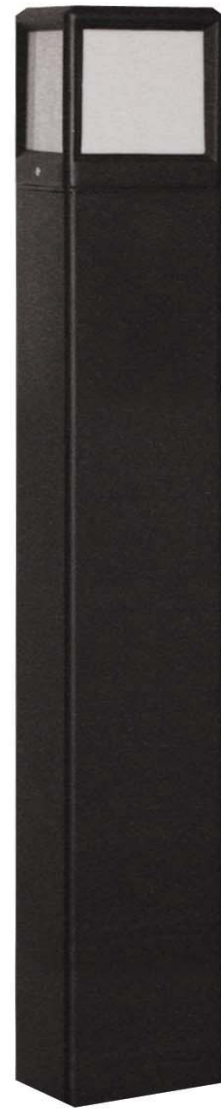
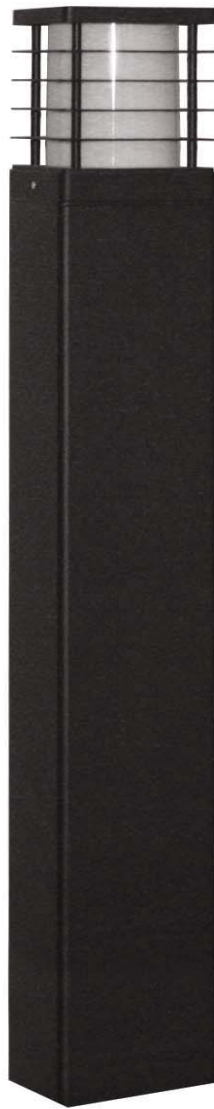
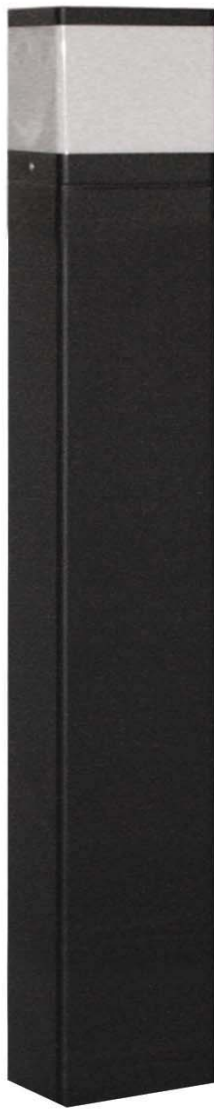

**BOL-2201**

E27 GENIE 18W

4,800.-

**BOL-2202**

E27 GENIE 18W

4,800.-

**BOL-2203**

E27 GENIE 18W

4,800.-

Material : Aluminum  
Voltage : 220-240V 50Hz  
110-130V 60Hz

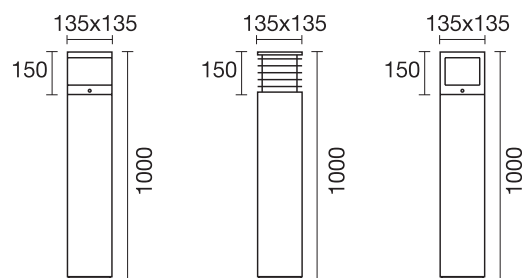

# BOL SERIES



**BOL-10SOA**  
E27 TORNADO 24W  
7,800.-

**BOL-10SOB**  
E27 TORNADO 24W  
8,300.-

**BOL-201S**  
G24 PL2x26W  
7,800.-  
(สกรีนหลอด)

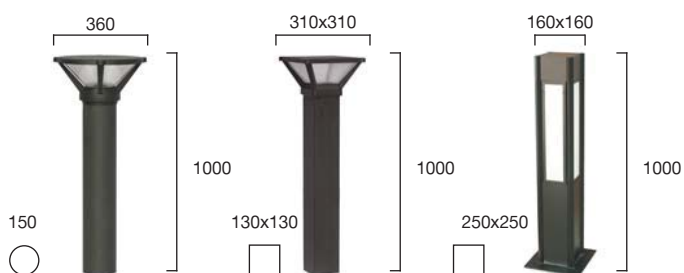

# BOL SERIES

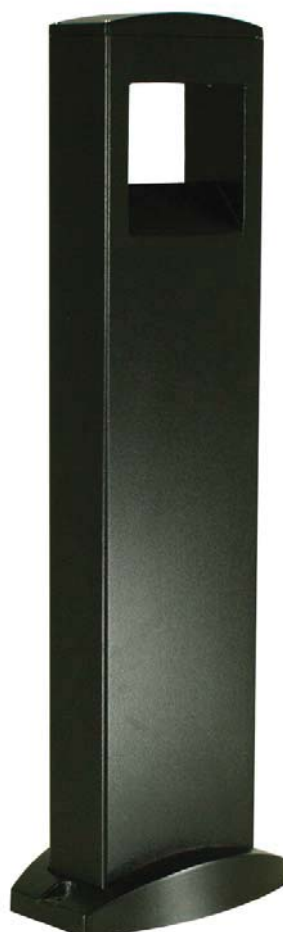

**BOL-0213/GU10**

GU10 LED 220V SW

4,400.-

**BOL-0218/LED**

LED 3W

4,400.-

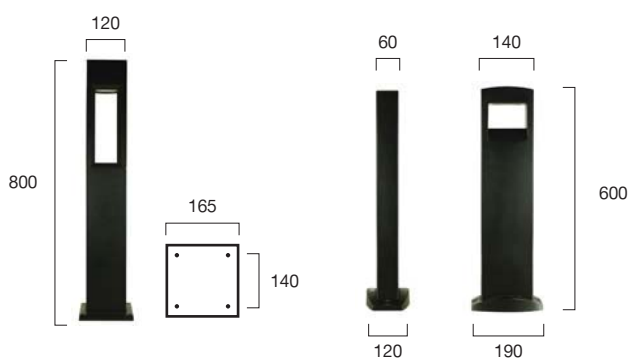

Material : Aluminum  
Voltage : 220-240V 50Hz  
110-130V 60Hz

# BOL SERIES



**BOL-0214/GU10**

GU10 LED 220V SW

4,200.-

**BOL-200**

E27 TORNADO 24W

4,800.-

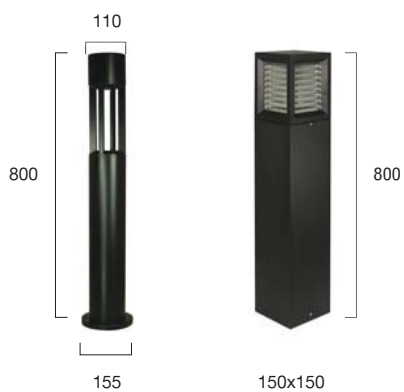

# BOR SERIES

## BOR-110

E27 TORNADO 24W

2,000.-



## BOR-120

E27 TORNADO 24W

2,200.-



## BOR-130

E27 TORNADO 4.5W

2,600.-

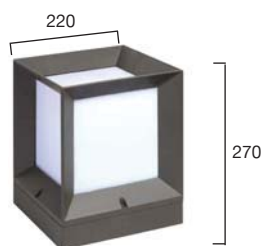

Material : Aluminum  
Voltage : 220-240V 50Hz  
110-130V 60Hz

# BOR SERIES

## BOR-140

E27 GENIE 18W

3,400.-



## BOR-150

E27 TORNADO 45W

3,500.-



Material : Aluminum  
Voltage : 220-240V 50Hz  
110-130V 60Hz

# BOR SERIES

## BOR-160

E27 GENIE 18W

2,000.-



## BOR-170

E27 GENIE 18W

2,440.-



## BOR-180/LED

LED 220V 4W 3000K

2,440.-

(ราคาสำหรับหลอด LED)

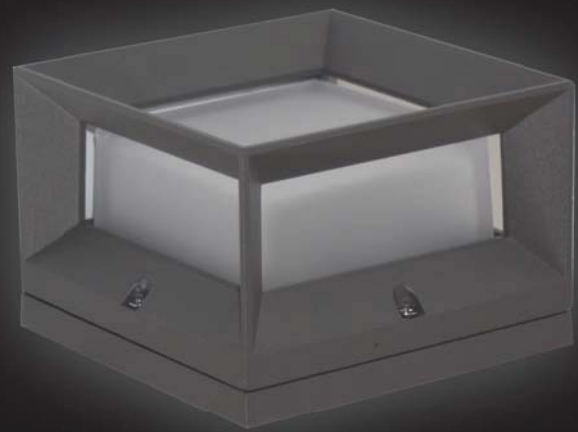

Material : Aluminum  
Voltage : 220-240V 50Hz  
110-130V 60Hz



# BOR SERIES

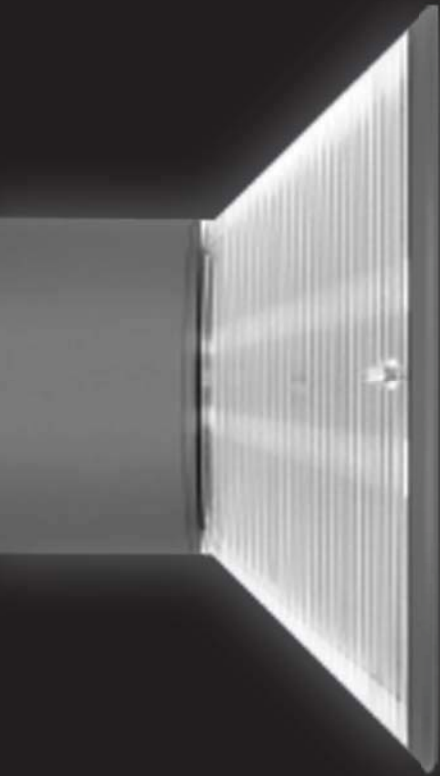

## BOR-2000

E27 GENIE 18W

3,230.-

## BOR-190

E27 GENIE 18W

1,800.-

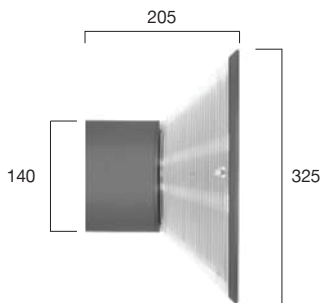

## BOR-200

E27 GENIE 18W

3,600.-



Material : Aluminum  
Voltage : 220-240V 50Hz  
110-130V 60Hz

# BOR SERIES

**BOR-0213**

GU10

3,480.-

**BOR-130/S**

E27 TORNADO 24W

1,920.

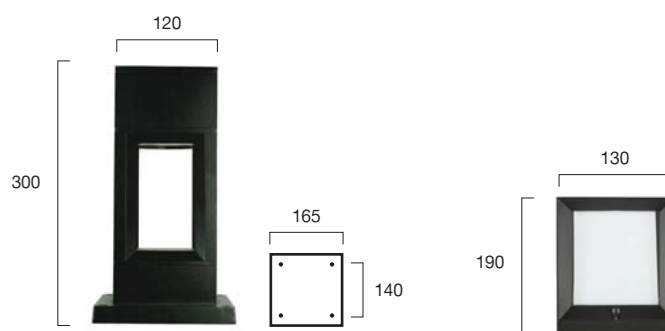

**BOR-0214/GU10**

GU10 LED 220V SW

3,240.-



Material : Aluminum  
Voltage : 220-240V 50Hz  
110-130V 60Hz

# UW SERIES



## UW-11016

MR16 12V 50W

LED 12V 6.5W

1,900.-



## UW-12011

QR11 12V 100W

LED-QR11 15W

2,800.-



## UW-13056

PAR56 12V 300W

8,500.-

Material : Stainless  
Voltage : AC 12V

# UW SERIES



**UW-18011**  
QT12 GY6.35 90W  
6,800.-  
(พร้อมสาย 2 เมตร)  
(Stainless 316)



**UW-19016**  
Gx5.3 12V 50W  
LED 12V 6.5W  
5,000.-  
(พร้อมสาย 2 เมตร)  
(Stainless 316)



**UW-14016**  
Gx5.3 12V 50W  
LED 12V 6.5W  
900.-



**UW-15016**  
Gx5.3 12V 50W  
LED 12V 6.5W  
900.-

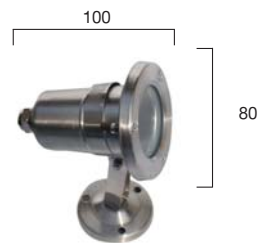



**UW-17111**

QT12 GY6.35 12V 90W

9,500.- (รวมกล่องฝังปูน)  
 (พร้อมสาย 2 เมตร) (Stainless 316)

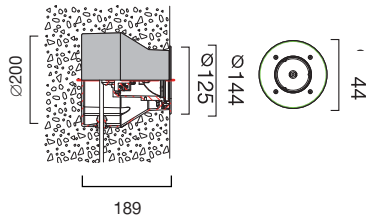

**UW-16116**

Gx5.3 12V 50W

LED 12V 6.5W

6,380.- (รวมกล่องฝังปูน)  
 (พร้อมสาย 2 เมตร) (Stainless 316)

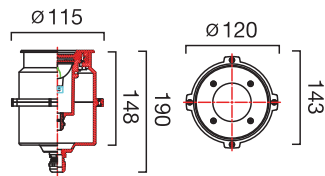

**UW-210 (สีขาว)**

QT12 GY6.35 12V 90W

2,400.-  
 (ABS)



# UW SERIES



LED-UW817

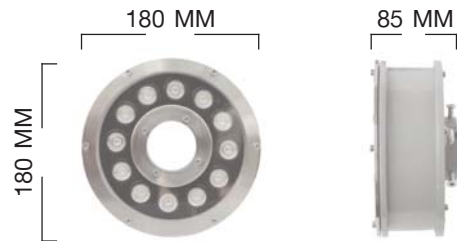

LED-UW817/WH Ø180-24V12x1.2 1SW- 6400K  
6,000.-

LED-UW817/WW Ø180-24V12x1.2 1SW- 3000K  
6,000.-

LED-UW817/RD Ø180-24V12x1.2 1SW- RED  
6,000.-

LED-UW817/GN Ø180-24V12x1.2 1SW- GREEN  
6,000.-

LED-UW817/BL Ø180-24V12x1.2 1SW- BLUE  
6,000.-

LED-UW817/YW Ø180-24V12x1.2 1SW- YELLOW  
6,000.-

LED-UW817/RGB Ø180-24V12x1.2 1SW- MIX  
6,000.-

IP68

ใช้กับหม้อแปลง 24V AC ทั่วๆไป

Material : วัสดุ Aluminium  
          ฝาครอบ Stainless 304  
          น๊อต Stainless  
          สายกันน้ำ 3 ม.

LED-FL-SD816/1S IP65  
 UW-G-SD816/1S IP68

LED-FL-SD816/1S/WH  
 Ø160-220V 15W- 6400K  
 3,600.-

LED-FL-SD816/1S/WW  
 Ø160-220V 15W- 3000K  
 3,600.-

LED-FL-SD816/1S/RD  
 Ø160-220V 15W-RE  
 3,800.-

LED-FL-SD816/1S/GN  
 Ø160-220V 15W-GN  
 3,800.-

LED-FL-SD816/1S/BL  
 Ø160-220V 15W-BL  
 3,800.-

LED-FL-SD816/1S/YW  
 Ø160-220V 15W-YE  
 3,800.-

LED-FL-SD816/1S/RGB  
 Ø160-220V 15W MIX  
 4,000.- ឆ្នាំ 7 ឆ្នាំ

UW-G-SD816/1S/WH  
 Ø160-24V 15W-6400K  
 3,600.-

UW-G-SD816/1S/WW  
 Ø160-24V 15W-3000K  
 3,600.-

UW-G-SD816/1S/RD  
 Ø160-24V 15W-RE  
 3,800.-



UW-G-SD816/1S/GN  
 Ø160-24V 15W-GN  
 3,800.-

UW-G-SD816/1S/BL  
 Ø160-24V 15W-BL  
 3,800.-

UW-G-SD816/1S/YW  
 Ø160-24V 15W-YE  
 3,800.-

UW-G-SD816/1S/RGB  
 Ø160-24V 15W-MIX  
 4,000.- ឆ្នាំ 7 ឆ្នាំ

សូម UW-G ប្រើប្រាស់តែជាមួយ 24V (AC)

# UW SERIES



LED-FL-7633/S  
UW-G-7633/S IP68

LED-FL-SD816  
UW-G-SD816 IP68

LED-FL-7633/S/WH  
220V 5W- 6400K  
2,640.-

LED-FL-7633/S/WW  
220V 5W- 3000K  
2,640.-

UW-G-7633/S/WH  
12V 5W- 6400K  
2,640.-

UW-G-7633/S/WW  
12V 5W- 3000K  
2,640.-

LED-FL-SD816/WH  
220V 10W- 6400K  
3,000.-

LED-FL-SD816/WW  
220V 10W- 3000K  
3,000.-

UW-G-SD816/WH  
12V 10W- 6400K  
3,000.-

UW-G-SD816/WW  
12V 10W- 3000K  
3,000.-

ឧបករណ៍ UW-G ប្រើប្រាស់ប្រភេទប្រព័ន្ធប្រព័ន្ធ 12V ក្នុងស្រុក



## L-PARS6WW252/15W



AC 12V, 15W

Warm White color, 252pcs LED 1300LM.

Diameter 177mm, height 100mm

**4,340.-**

## L-PARS6WW150/S730/30W



AC 12V, 30W

Warm White color, 150 pcs

SMD5730 LED 2500LM.

Diameter 177mm, height 100mm

**6,160.-**

## L-PARS6RGB75/S050/15W



AC 12V, 15W

RGB, 75pcs SMD5050 LED 550LM.

Diameter 177mm, height 100mm.

Remote control

**5,670-**

# UW SERIES

## UW-PF-SS-PAR56



Size: Surface diameter is 296mm,  
Housing diameter 218mm,  
The height of housing is 135mm.  
Material : ABS, Stainless steel

**4,900.-** (ราคาเฉพาะโคม)

## UW-M252WW/ABS/15W UW-M252RGB/ABS/15W



AC 12V, 15W  
Warm White color,  
252pcs LED ,1300LM.  
Diameter 295mm, height 70mm,  
Wall-mounted type,  
Cable 2x1.5 (3 M.)  
ABS housing  
(ใช้กับหม้อแปลงขดลวด 12V)

**6,160.-** (WW)

**7,800.-** (RGB)

## UW-M252WW/SS/15W



AC 12V, 15W  
Warm White color, 252pcs LED ,1300LM.  
Diameter 300mm, height 70mm,  
Wall-mounted type  
Cable 2x1.5 (3 M.)  
Stainless Steel housing

**7,140.-**

## BL-TRWP-50W



Waterproof transformaer  
Input AC220V, 50Hz,  
Output Ac12V. 50W.  
IP65

**1,750.-**



## BL-TRWP-100W

Waterproof transformaer,  
Input AC220V, 50Hz,  
Output Ac12V. 100W.  
IP65

**2,380.-**



## BL-TRWP-300W

Waterproof transformaer,  
Input AC220V,50Hz,  
Output Ac12V. 300W.  
IP65

**4,480-**

# UW SERIES

## UW-G-17S1

Material : Stainless  
Holder : GUS.3  
LAMP : LED 12V SW  
Price : 4,000.-

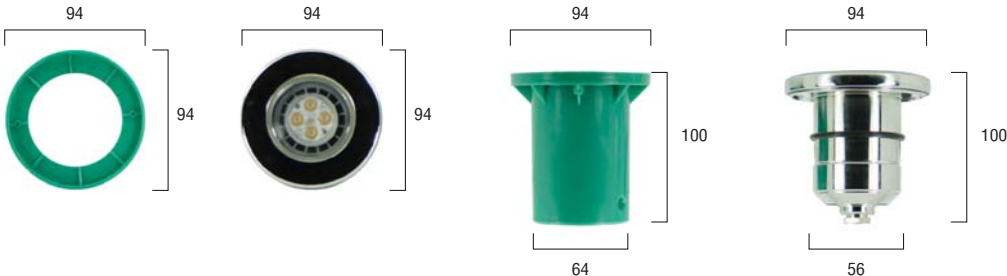

LED-IN-JD006



LED-IN-JD006/15/WH

24V 15W- 6400K

3,600.-

LED-IN-JD006/15/WW

24V 15W- 3000K

3,600.-

LED-IN-JD006/15/GN

24V 15W-GN

3,800.-

LED-IN-JD006/15/BL

24V 15W-BL

3,800.-

LED-IN-JD006/15/RD

24V 15W-RE

3,800.-

LED-IN-JD006/15/YW

24V 15W-YE

3,800.-

LED-IN-JD006/15/RGB

24V 15W-MIX

4,000.-

IP67

ใช้กับหลอด LED 24V (AC) ทั่วๆไป

# IN SERIES



## LED-IN-JD005

- LED-IN-JD005/220/WH  
220V 10W- 6400K  
3,000.-
- LED-IN-JD005/220/WW  
220V 10W- 3000K  
3,000.-
- LED-IN-JD005/12/WH  
12V 10W- 6400K  
3,000.-
- LED-IN-JD005/12/WW  
12V 10W- 3000K  
3,000.-

## LED-IN-JD004

- LED-IN-JD004/220/WH  
220V SW-6400K  
2,000.-
- LED-IN-JD004/220/WW  
220V SW- 3000K  
3,000.-

IP67  
 ระบุ 12V ใช้กับหม้อแปลง 12V AC กว้าง

# IN SERIES

## LED-IN268

LED 1W 12V 3000K  
1,440.-



## LED-IN269

LED 1W 12V 3000K  
1,440.-



ใช้กับหม้อแปลง 12 V หัวโป๊ว

Material : STAINLESS STEEL 304  
Voltage : 12V  
IP : 67

TEL. 034-872577 FAX 034-872566

IN-3

# IN SERIES



## LED-IN277

LED 1.4W 3000K

1,900.-

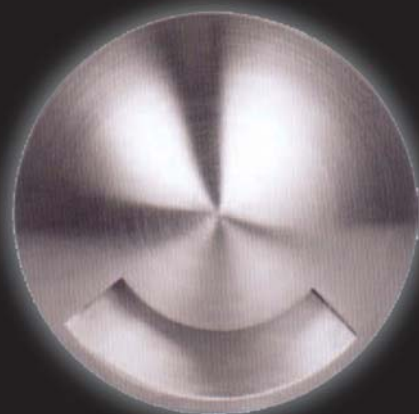

## LED-IN278

LED 1.4W 3000K

1,900.-

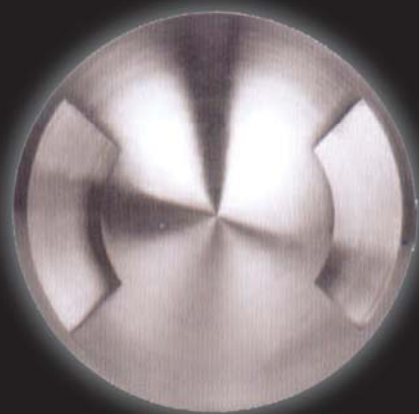

## LED-IN279

LED 1.4W 3000K

1,900.-



## LED-IN280

LED 1.4W 3000K

1,900.-

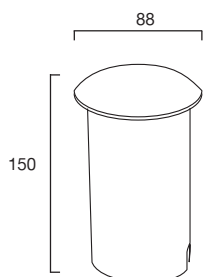

IN-4

LIGHTTRIO



# IN SERIES



## IN-1016

GUS.3 12V 50W  
MR16 LED 12V 6.5W  
LED 220V 3W  
1,200.-



## IN-1116

GUS.3 12V 50W  
MR16 LED 12V 9W  
LED 220V 3W  
1,300.-

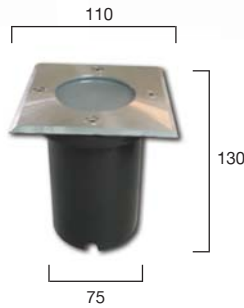

## IN-2601

G12 CDM-T 70W  
5,800.-

(พร้อมกล่องฝังปูน)



## IN-1516

GUS.3 12V 50W  
MR16 LED 12V 6.5W  
LED 220V SW  
1,800.-

(ปรับองศาได้)



Material : Aluminum  
Voltage : 220-240V 50Hz  
110-130V 60Hz

TEL. 034-872577 FAX 034-872566

IN-5

# IN SERIES



## IN-1227

E27 TORNADO 24W

E27 PAR30 100W

1,700.-



## IN-1311/ADJ

QR111 12V SOW

LED QR111 12V 15W

1,200.-



## IN-1411/ADJ

QR111 12V SOW

LED QR111 12V 15W

1,200.-



**IN-1616** (TRIM, STAINLESS316)

GUS.3 MR16 12V 50W

GUS.3 LED 12V 6.5W

3,450.-

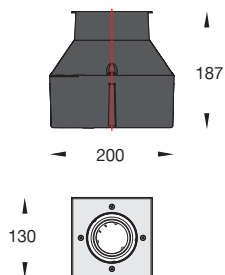
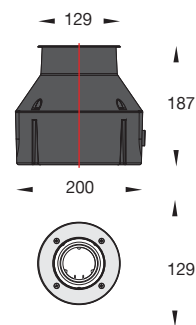

**IN-1716** (TRIM, STAINLESS316)

GUS.3 MR16 12V 50W

GUS.3 LED 12V 6.5W

3,500.-

# IN SERIES

## IN-1827

G12 CDM-T 35W

G24 PLC 26W

7,850.- PLC 26W רכישת מוצר

10,500.- MH 35W רכישת מוצר

10,500.- MH 70W רכישת מוצר

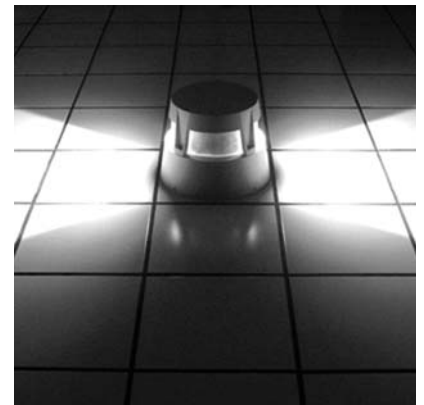
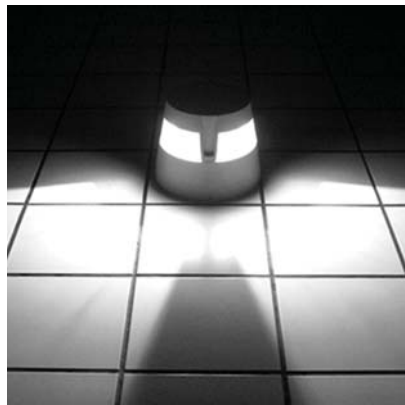
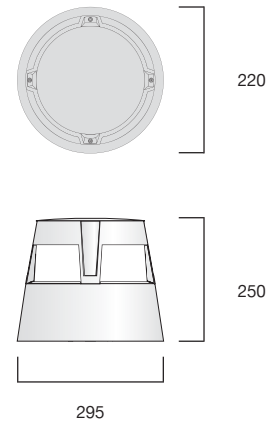

גודל 1, 2 או 4 צל

IP : 65  
Material : Die-Cast Aluminum  
Voltage : 220-240V 50Hz  
110-130V 60Hz

**PT-10112**

Lamp : G12 HIT-CE 70-150W  
 Material : Aluminum  
 Pole : 2-6 meter ใช้เสา PT-01 (10)

**ราคาเหมาจ่าย**

34,050.- (70W พร้อมแบตเตอรี่)

34,600.- (150W พร้อมแบตเตอรี่)



**PT-11112**

Lamp : G12 HIT-CE 70-150W  
 Material : Aluminum  
 Pole : 2-6 meter ใช้เสา PT-01 (10)

**ราคาเหมาจ่าย**

17,820.- (70W พร้อมแบตเตอรี่)

18,420.- (150W พร้อมแบตเตอรี่)

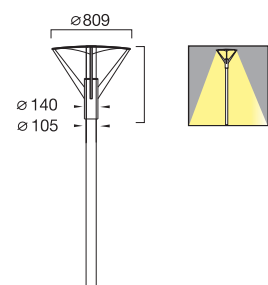
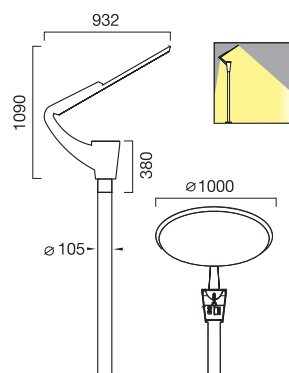

# PT SERIES

## PT-30112

Lamp : G12 HIT-CE 70-150W

Material : Aluminum

Pole : 2-6 meter ใช้เสา PT-01 (10)

## ราคาเฉพาะโคม

16,000.- (MH70W พร้อมบัลลาสต์)

16,500.- (MH150W พร้อมบัลลาสต์)

ปรับมุมองศาได้

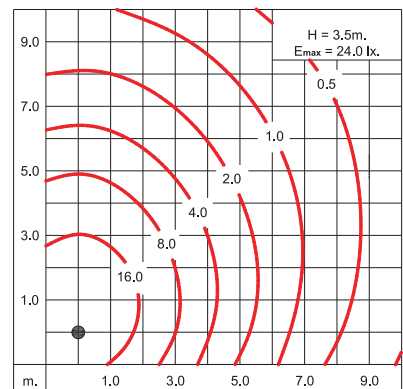
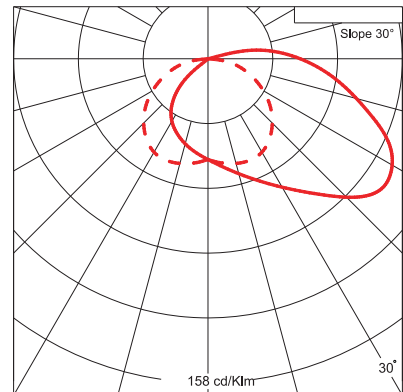
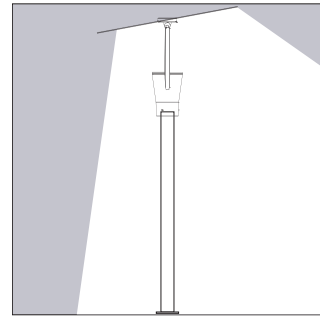
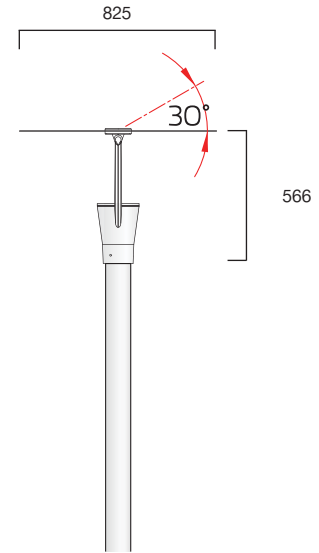
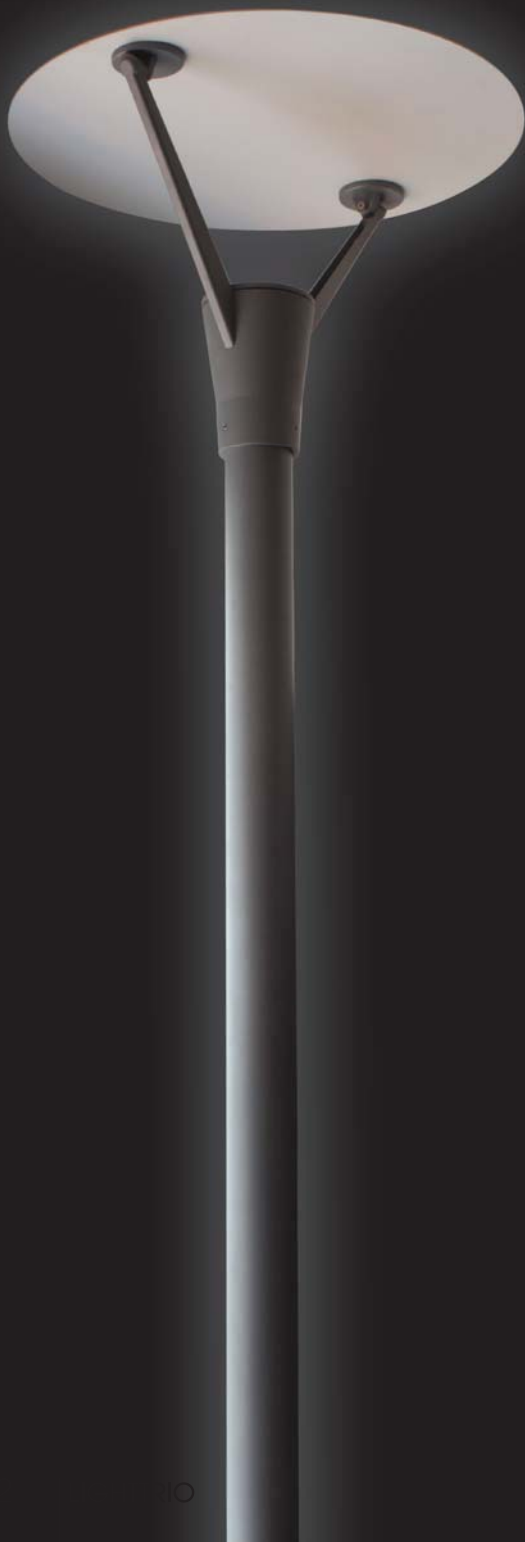

**BEST SELLER**



## PT-15127

Lamp : E27 HIE-CE 70W-150W

Material : Aluminum

Pole : 2-6 meter ใช้เสา PT-01 (10)

### ราคาเหมาจ่าย

12,240.- (MH70W พร้อมเบ้าลวด)

12,840.- (MH150W พร้อมเบ้าลวด)



## PT-14112

Lamp : E27 HIE-CE 70W-150W

Material : Aluminum

Pole : 2-6 meter ใช้เสา PT-01 (10)

### ราคาเหมาจ่าย

15,200.- (MH70W พร้อมเบ้าลวด)

15,800.- (MH150W พร้อมเบ้าลวด)



## PT-13127

Lamp : E27 HIE-CE 70W

Material : Aluminum

Pole : 2-6 meter ใช้เสา PT-01 (10)

### ราคาเหมาจ่าย

13,300.- (MH70W พร้อมเบ้าลวด)

11,800.- (MV80W พร้อมเบ้าลวด)

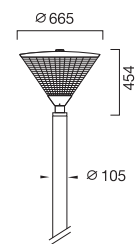
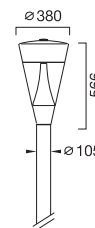
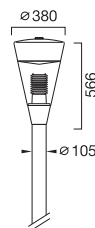

# PT SERIES

## PT-19321

Lamp : GS TS 3x21W  
Material : Aluminium, Steel  
20,000.- (အပူခဲ 3 ပု.)  
21,000.- (အပူခဲ 3.5 ပု.)  
22,000.- (အပူခဲ 4 ပု.)

## PT-18127

Lamp : E27 HIE-CE 70W  
Material : Aluminium, Steel  
15,000.- (အပူခဲ 3 ပု.)  
16,000.- (အပူခဲ 3.5 ပု.)

## PT-16321

Lamp : GS TS 3x21W  
Material : Aluminium, Steel  
16,000.- (အပူခဲ 3 ပု.)  
17,000.- (အပူခဲ 3.5 ပု.)  
18,000.- (အပူခဲ 4 ပု.)

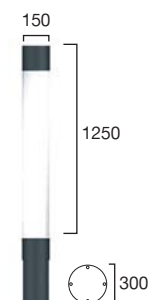
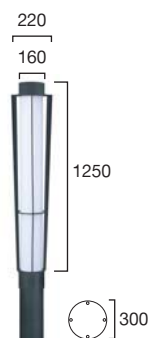



PT-17127

Lamp : E27 HIE-CE 70W  
 Material : Aluminum  
 Pole : 2-6 meter ใช้ เสา PT-01 (7)

ราคาพละ:คค

12,000.-

PT-27127

Lamp : E27 TORNADO 65W  
 Material : Aluminum  
 Pole : 2-6 meter ใช้ เสา PT-02 (7)

ราคาพละ:คค

9,000.-



PT-21127

Lamp : E27 HIE-CE 70W  
 Material : Aluminum  
 Pole : 2-4 meter ใช้ เสา PT-02 (7)

ราคาพละ:คค

12,000.-

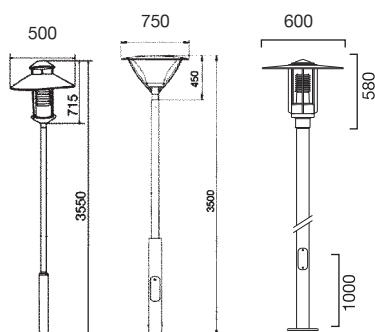

(โคม: Acrylic)

# PT SERIES

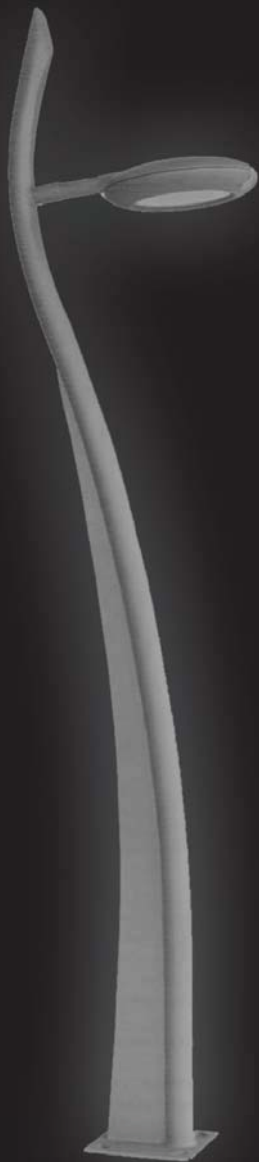

## PT-24328

Lamp : LEDT8 3x18W (3000K)  
GS TS 3x28W

Material : Steel  
Diffuser : Acrylic

19000.- (3.5 מ. TS)

21,000.- (4 מ. TS)

24,000.- (3.5 מ. LED)

26,000.- (4 מ. LED)

## PT-31428

Lamp : TS 4x28W  
(2700, 4000, 6400K)

Material : Steel

מחיר 3 עמודים PT-31328

4 עמודים PT-31428

17,000.- (3 מ. 3 עמודים)

17,500.- (3 מ. 4 עמודים)

18,000.- (3.5 מ. 3 עמודים)

18,500.- (3.5 מ. 4 עמודים)

19,000.- (4 מ. 3 עמודים)

19,500.- (4 מ. 4 עמודים)

מעליות חלודה LED

חלודה: 1,500.-



## PT-29127

Lamp : E27 HIE-CE 70W

Material : Aluminium

שימוש במונח WB009

הצעה 3.5 מ. 12,500.-

הצעה 4 מ. 14,000.-

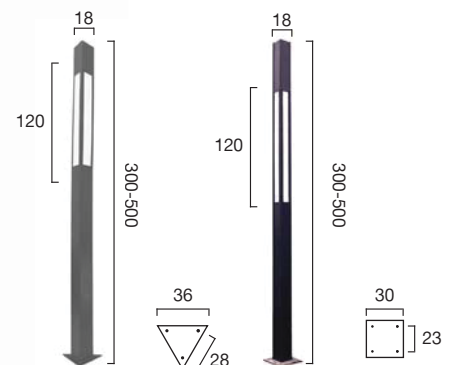
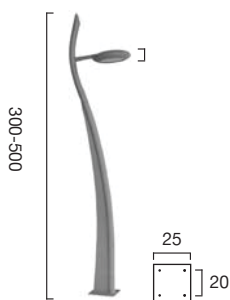

# PT SERIES



## PT-812

Material : Aluminium + Acrylic

Holder : E27 Tonado 4SW

Price : 10,000.-



# ESPL SERIES

UD-11604

Lamp : LED90 3000K  
3,200.-  
: Gx53 12W  
3,000.-



BOL-11601

Lamp : LED90 3000K  
5,600.-  
: Gx53 12W  
5,400.-



BOR-11609

Lamp : LED90 3000K  
3,400.-  
: Gx53 12W  
3,200.-

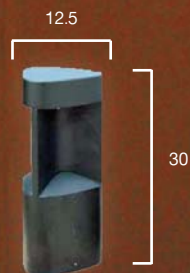
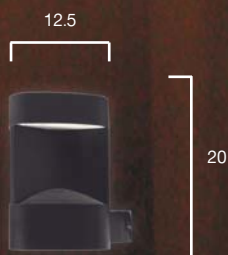

ราคาสินค้าพร้อมหลอด

Material : Die-Cast Aluminum  
Voltage : 220-240V 50Hz  
110-130V 60Hz

# ESPL SERIES

ราคาสินค้าพร้อมหลอด

BOL-11205

Lamp : LED90 3000K  
5,600.-  
: Gx53 12W  
5,400.-

BOR-11206

Lamp : LED90 3000K  
2,800.-  
: Gx53 12W  
2,600.-

BOR-11201

Lamp : LED90 3000K  
3,600.-  
: Gx53 12W  
3,400.-

BOR-11207

Lamp : LED90 3000K  
3,200.-  
: Gx53 12W  
3,000.-

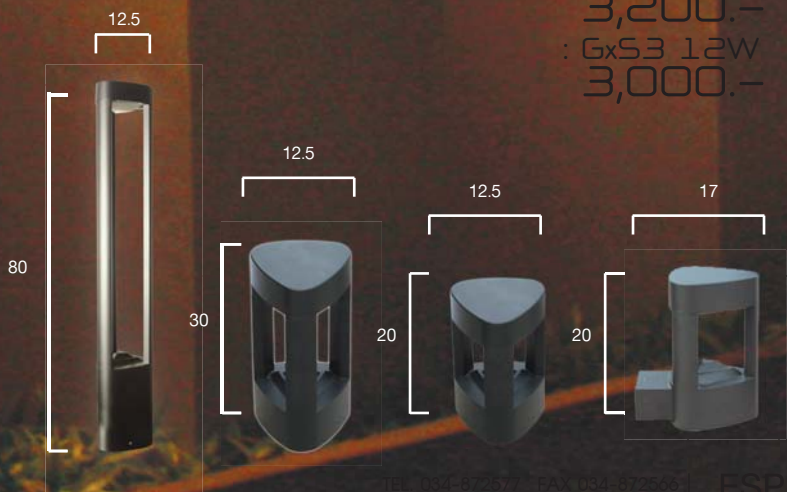

# ESPL SERIES



UD-11307

Lamp : E27 GENIE 18W  
2,800.-



BOL-11306

Lamp : E27 GENIE 18W  
4,000.-



BOR-11304

Lamp : E27 GENIE 18W  
2,400.-



# ESPL SERIES

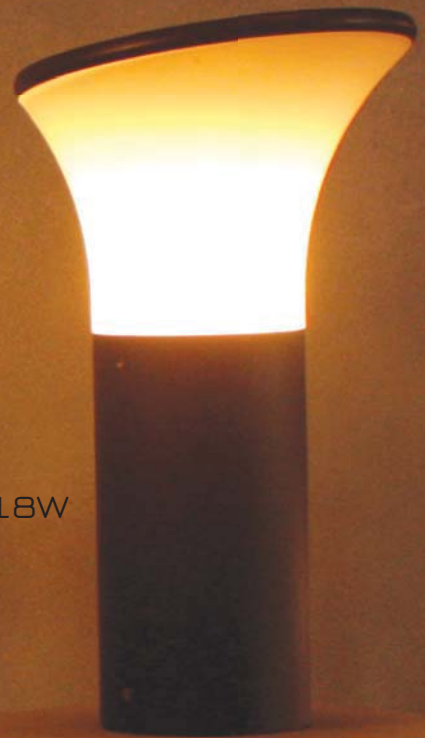

BOR-1140S  
Lamp : E27 GENIE 18W  
3,400.-

UD-11408  
Lamp : E27 GENIE 18W  
3,200.-

BOL-11407  
Lamp : E27 GENIE 18W  
4,800.-



Material : Die-Cast Aluminum  
Voltage : 220-240V 50Hz  
110-130V 60Hz

# ESPL SERIES

BOL-11706

Lamp : LED90 3000K  
5,600.-

BOL-11705

Lamp : LED90 3000K  
5,200.-



ราคาสินค้าพร้อมหลอด

Material : Die-Cast Aluminum  
Voltage : 220-240V 50Hz  
110-130V 60Hz



# DOWNLIGHT SERIES



**DB-C111/L**  
E27 GENIE 14W  
1,000.-



**DB-C121/L**  
E27 TORNADO 24W  
1,600.-



**DB-C191/L**  
E27 TORNADO 24W  
1,400.-

Material : Aluminum  
Voltage : 220-240V 50Hz  
110-130V 60Hz

# DOWNLIGHT SERIES

**HDL-S600-1**  
GU10 220V 50W  
LED GU10 SW  
1,000.-



**HDL-S600-2**  
GU10 220V 50W  
LED GU10 SW  
2,000.-

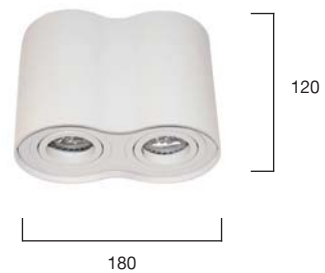

ปรับองศาได้

Material : Aluminum

Voltage : 220-240V 50Hz

110-130V 60Hz

# DOWNLIGHT SERIES



**HDL-S601**  
GU10 220V 50W  
LED GU10 SW  
1,200.-



**HDL-S602**  
GU10 220V 50W  
LED GU10 SW  
2,400.-

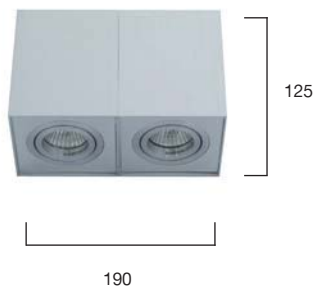

ปรับองศาได้

Material : Aluminum

Voltage : 220-240V 50Hz  
110-130V 60Hz

# DOWNLIGHT SERIES

**HDL-S901-QR111**

QR111 12V 100W

1,150.-



**HDL-S902-QR111**

QR111 12V 100W

2,300.-

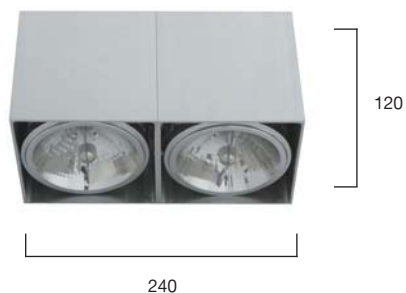

ปรับองศาได้

Material : Aluminum

Voltage : 220-240V 50Hz  
110-130V 60Hz

DOWNLIGHT-4

LIGHTTRIO

# DOWNLIGHT SERIES



## HDR-7302

E27 PAR38 120W 4,200.- (โคมเปล่า)  
 G24 PLC 26W 4,550.- (พร้อมบัลลาสต์)  
 G12 CDM-T 35x70W 7,200.- (พร้อมบัลลาสต์)

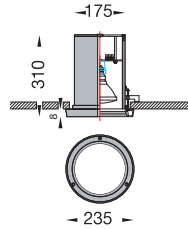

## HDR-7312

E27 PAR20 50W 2,500.- (โคมเปล่า)  
 GU10 LED 220V SW 2,600.- (โคมเปล่า)

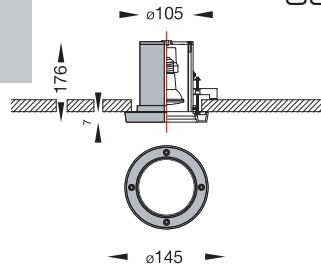

## HDR-7322

E27 PAR30 75W 4,700.- (โคมเปล่า)  
 G12 CDM-T 35,70W 7,600.- (พร้อมบัลลาสต์)

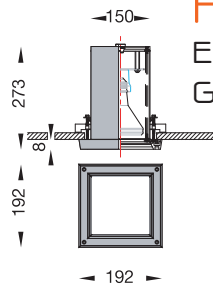

## HDR-7332

E27 PAR20 50W 2,700.- (โคมเปล่า)  
 GU10 LED 220V SW 2,800.- (โคมเปล่า)

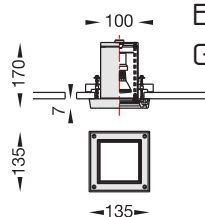

Material : Aluminum  
 Voltage : 220-240V 50Hz  
 110-130V 60Hz

# FLUORESCENCE SERIES

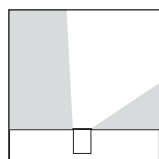

ASSYM

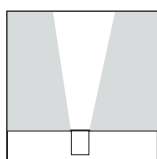

SYM

TS-IN

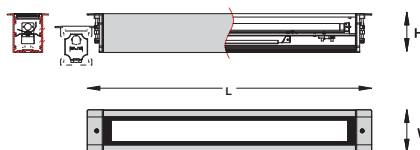
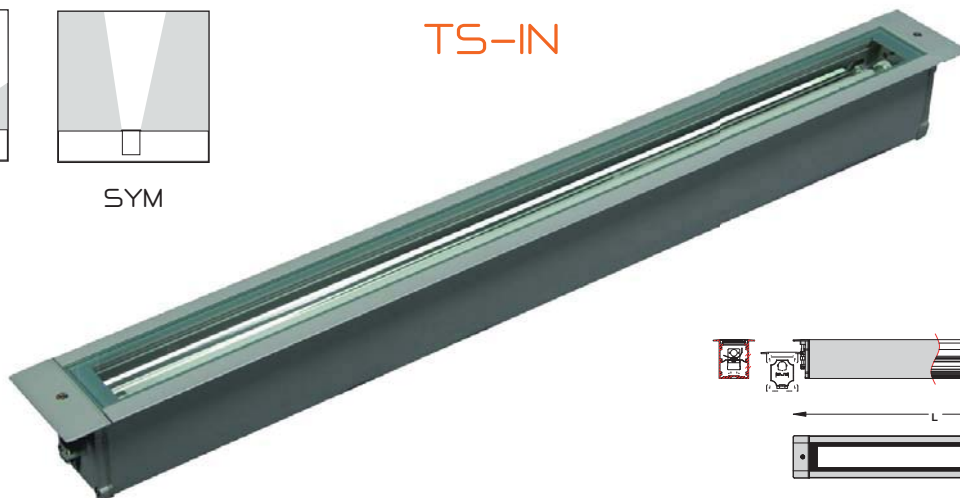

MODEL	TYPE	LxWxH	PRICE (พร้อมบัลลาสต์)
T5-IN14/SYM	T5 14W	674x100x92	6,700.-
T5-IN21/SYM	T5 21W	978x100x92	7,950.-
T5-IN28/SYM	T5 28W	1273x100x92	9,870.-
T5-IN14/ASSYM	T5 14W	674x100x92	6,700.-
T5-IN21/ASSYM	T5 21W	978x100x92	7,950.-
T5-IN28/ASSYM	T5 28W	1273x100x92	9,870.-



TS-INBOX

MODEL	TYPE	LxWxH	PRICE
T5-IN14BOX	T5 14W	662x128x145	1,380.-
T5-IN21BOX	T5 21W	962x128x145	1,750.-
T5-IN28BOX	T5 28W	1262x128x145	2,050.-

# FLUORESCENCE SERIES

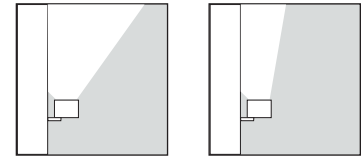
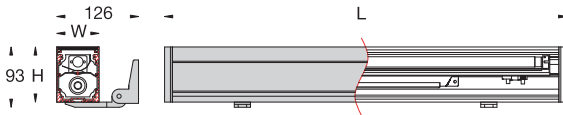

SYM

ASSYM

MODEL	TYPE	LxWxH	PRICE (พร้อมบัลลาสต์)
T5-WL14/SYM	T5 14W	620x65x85	5,150.-
T5-WL21/SYM	T5 21W	924x65x85	6,000.-
T5-WL28/SYM	T5 28W	1219x65x85	7,200.-
T5-WL14/ASSYM	T5 14W	620x65x85	5,150.-
T5-WL21/ASSYM	T5 21W	924x65x85	6,000.-
T5-WL28/ASSYM	T5 28W	1219x65x85	7,200.-

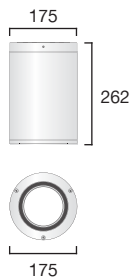

## HDL-4003

E27 PAR38 120W 3,400.- (โคมเปล่า)  
 G24 PLC 26W 4,250.- (พร้อมบัลลาสต์)  
 G12 CMD-T 35,70W 7,200.- (พร้อมบัลลาสต์)

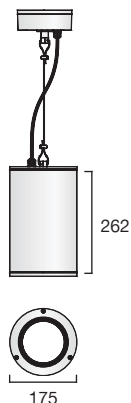

## HHL-1016

E27 PAR38 120W 4,480.- (โคมเปล่า)  
 G24 PLC 26W 4,800.- (พร้อมบัลลาสต์)  
 G12 CMD-T 35,70W 7,550.- (พร้อมบัลลาสต์)

# CLASSIC SERIES



## NA1001

E27 TORNADO 65W

7,000.- (គុណប្រាក់)

ប្រើភ្នំប្រភេទ F100 (7)

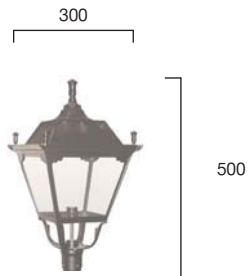

## NA1002

E27 TORNADO 65W

9,000.- (គុណប្រាក់)

ប្រើភ្នំប្រភេទ F100 (7)

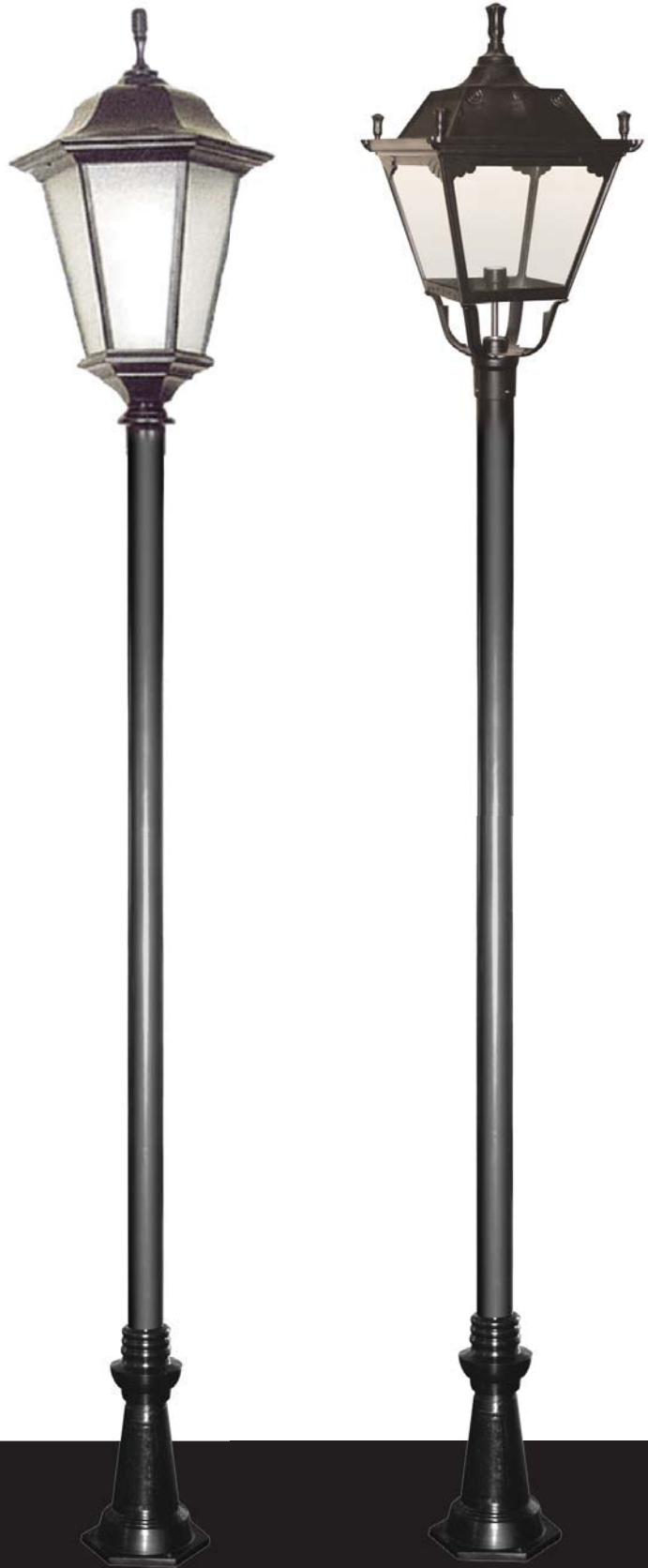



# CLASSIC SERIES



**O-1010W**

E27 GENIE 18W

1,400.- (ໄກມເວ້າ)



**O-1010S**

E27 GENIE 18W

1,400.- (ໄກມເວ້າ)



# CLASSIC SERIES

**0-9002W/S**  
E27 GENIE 18W  
1,500.-

**0-9002W/L**  
E27 GENIE 18W  
1,750.-



**BOL-9002**  
E27 GENIE 18W  
3,600.-

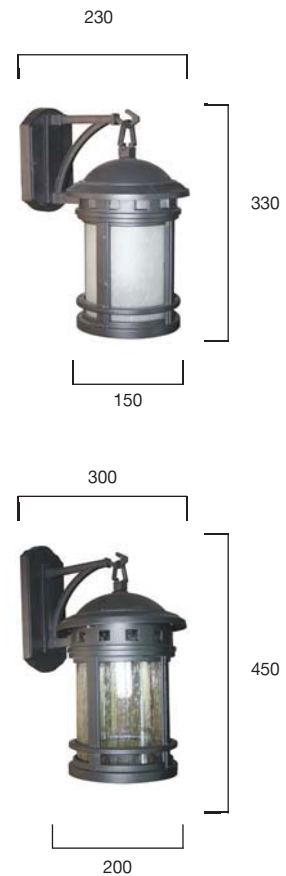

# SOLAR SERIES



## SOLAR-PT-15127

Lamp : LED 12V DC 20W  
Material : Aluminum  
Pole : 3-4 meter  
N/A



## SOLAR-PT-29127

Lamp : LED 12V DC 20W  
Material : Steel  
Pole : 3-4 meter  
N/A



## SOLAR-PT-801-3

Lamp : LED 12V DC 20W  
Material : Aluminum  
Pole : 3-4 meter  
N/A



## SOLAR-PT-802-1

Lamp : LED 12V DC 20W  
Material : Aluminum  
Pole : 3-4 meter  
N/A

## SPECIFICATION

แผงโซลาร์ขนาด 80W ชนิด Poly Crystalline.

โคมไฟหลอด LED ขนาด 20 W

หลอดอายุการใช้งาน 50,000 ชั่วโมง ทึบกำลัง 0.8Ah/1 ชั่วโมง  
แสง 5000K

แบตเตอรี่ลิเธียมขนาด 12V 33Ah.

อุปกรณ์จ่ายกระแส 12Ah

โดยจะเปิดอัตโนมัติตอนกลางคืน 12 ชั่วโมง

(เมื่อแบตเตอรี่เต็ม ทำงานต่อเนื่อง 36 ชั่วโมง (3 วัน))



<http://itthirit.com/>

<http://lighttrio.com/>

<http://facebook.com/ITLighting>