



Lightttrio

2017-2019
WWW.LIGHTTRIO.COM

1

2



INDOOR LIGHTING



COMPANY PROFILE

บริษัท อิทธิฤทธิ์ อิเลคตริก จำกัด ก่อสร้างขึ้นเมื่อปี 2538 ประกอบธุรกิจ จัดจำหน่ายผลิตภัณฑ์โคมไฟฟ้าแสงสว่างอย่างครบวงจร นับตั้งแต่การ นำเข้าและส่งออก ให้ลูกค้าทุกกลุ่มทั้งในและต่างประเทศ นอกจากนี้บริษัทฯ ยังมีบริการเสริมต่างๆ เพื่อให้ลูกค้าได้ประโยชน์มากที่สุด รวมทั้งออกแบบ ระบบแสงสว่างสำหรับงานต่างๆ ออกแบบระบบแสงสว่างให้เหมาะกับลักษณะ ของงาน ตลอดจนการให้บริการเข้าผลิตภัณฑ์โคมไฟฟ้าแสงสว่างและระบบ ไฟฟ้าแสงสว่างสำหรับงานต่างๆผลิตภัณฑ์ของบริษัทมีความหลากหลาย และครบครันสามารถรองรับความต้องการของลูกค้าที่ใช้ไฟฟ้าแสงสว่าง ได้ทุกกลุ่ม เช่น หมู่บ้านจัดสรร, ทาวน์เฮาส์, ทาวน์โฮม, บ้านเดี่ยว, คอนโดมิเนียม, อพาร์ทเมนต์, อาคารพาณิชย์, ศูนย์การค้า, ตึกสูง, สำนักงาน, โชว์รูม, ร้านค้า, ร้านอาหาร, โรงงานอุตสาหกรรม, โรงพยาบาล, โรงแรม, โรงเรียน, มหาวิทยาลัย, คลังสินค้า, สาธารณะ, สนามบิน, หน่วยงานภาครัฐ, หน่วยงานวิสาหกิจ

บริษัทได้รับความไว้วางใจจากโครงการคอนโดมิเนียม, หมู่บ้านจัดสรร, พุฒิมหา, พุฒินาอสังหาริมทรัพย์, เจ้าของโครงการขนาดใหญ่ ในการเลือกใช้โคมไฟ, เสาลโคมไฟสนาม, ไฟพลังงานแสงอาทิตย์, ไฟสำหรับตกแต่งภายในอาคารและ ไฟสำหรับตกแต่งภายในอาคารของ LIGHTTRIO



บริษัท อิทธิฤทธิ์ อิเลคตริก จำกัด



บริษัท อิทธิฤทธิ์ อิเลคตริก จำกัด

89/18-19, 98/18-19 หมู่ 5 ตำบลพันท้ายนรสิงห์
อำเภอเมืองสมุทรสาคร จังหวัดสมุทรสาคร 74000
Tel.: 034-872-577, 034-446-258, 034-446-265
Fax.: 034-872566, 034-446-267



- Galerie rue de 39
- Rhythm Condo
- Life Condo
- The Classe
- The Palazzo
- Soul
- Centro



- Plum Condo
- Chapter One
- Urbano



- Notting Hill
- Knightsbridge
- Kensington
- Pause Condo
- The Cabana
- Tropicana



- Lumpini Place
- Lumpini Ville



- Maestro
- M ทองหล่อ
- M จตุจักร



- Metro Sky
- Perfect Masterpiece
- Perfect Place
- The Metro
- Modi Villa

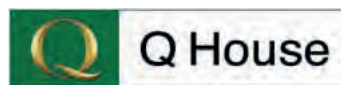

- Q Twelve
- Q Avenue
- พุทธรักษา
- สัตตมารมย์
- คาซ่า



- Narasiri
- The Base
- The Line
- D Condo
- บ้านเคียงฟ้า



- ทรานดา
- Grand Bangkok
- เดอะ เชนท์
- เดอะ เกรสท์
- เซ็นทริค
- แบงค็อก



- J City
- J Grand



A member of MUFG, a global financial group

ทำไมต้องใช้ หลอดไฟ โคมไฟ **LED** ???

- ค่าส่องสว่างต่อวัตต์สูง (ประสิทธิภาพสูง) กว่าหลอดแบบเดิม (High Efficacy)
- ส่องสว่างแบบมีทิศทาง ลดการสูญเสียของแสง (Directional Light)
- อายุการใช้งานยาวนาน (Long Lifespan)
- แสงลดม่น้อยตลอดอายุการใช้งาน หรือแสงไม่ดริอป (Low Lumen Depreciation)
- จุดติดทันที (Instant Start) ไม่ต้องรอการกระพริบ
- ไม่มีรังสี UV
- ไม่แผ่รังสีความร้อน
- ไม่มีสารปรอท
- ทนต่อแรงสั่นสะเทือน (Vibration)



ขั้วหลอดไฟ LED มีกี่แบบ ?

โดยหลักๆ ขั้วหลอดไฟจะมีที่ใช้กันโดยทั่วไปไม่กี่ประเภท แต่ในที่นี้เราจะมาแนะนำในส่วนขอ ขั้วหลอดไฟที่เราใช้กันทั่วไปและพบเห็นได้บ่อยๆ



ขั้ว E14 : หรือที่เรียกกันว่า "ขั้วเล็ก" สำหรับขั้วหลอดไฟ E14 นิยมใช้กับหลอดรูปทรงจำปา หรือ ทรงกระบอกเล็ก



ขั้ว E27 : เป็นขั้วหลอดไฟที่พบเห็นได้มากที่สุด เพราะนิยมนำมาใช้กับหลอดไฟหลากหลายแบบ โดยทรงที่นิยม คือ LED BULB (ทรงน้ำเต้า)



ขั้ว E40 : เป็นขั้วหลอดไฟที่คล้ายเหมือนกับ ขั้ว E27 แต่มีขนาดใหญ่กว่า สำหรับขั้วหลอดไฟ E40 นิยมใช้กับหลอดที่มีกำลังวัตต์สูงๆ โดยทั่วไปจะใช้กับหลอดที่มีกำลังวัตต์มากกว่า 40W ขึ้นไป



ขั้ว B22 : เป็นขั้วหลอดไฟชนิดบิดล็อก ซึ่งที่ขั้วหลอดจะมีขั้วเล็กๆ ยื่นออกมา 2 จุด เพื่อเกี่ยวกับฐานใส่หลอดไฟ ทำให้การใส่และถอดรวดเร็ว เหมาะกับการใส่จำนวนมากๆ



ขั้ว G13 : คือขั้วหลอดไฟชนิดหลอดยาว ซึ่งต้องใช้ควบคู่กับบัลลาสต์และสตาร์ทเตอร์ แต่ในปัจจุบันมีหลอด LED TUBE ช่วยทำให้ประหยัดไฟลงได้มากขึ้น ติดตั้งง่าย ไม่ต้องใช้บัลลาสต์และสตาร์ทเตอร์ ให้ความสว่างมากกว่าและความร้อนต่ำกว่า



ขั้ว GU10 : หรือขั้วขาสตาร์ทเตอร์ ลักษณะจะเหมือนกับขั้วสตาร์ทเตอร์ คือ มีขาบิดล็อกได้ ซึ่งขั้ว GU10 มักจะพบเห็นในหลอดฮาโลเจนแบบถ้วย MR16 ซึ่งหลอดดังกล่าวนิยมนำมาใช้กับโคมไฟติดราง ซึ่งเหมาะกับหลอดไฟบางประเภทเท่านั้น



ขั้ว GX5.3 : นิยมนำมาใช้กับหลอดฮาโลเจนแบบถ้วย และ ฮาโลเจนแบบแคปซูล ซึ่งลักษณะขั้วจะเป็นเหล็กกลมสั้นๆ 2 แท่ง ที่ตัวหลอด โดยตัวเลข 5.3 คือ ระยะห่างของแท่งเหล็กทั้ง 2 แท่ง (หน่วยเป็นมิลลิเมตร)



การอ่านค่าอุณหภูมิของสี Color Temperature

ค่าอุณหภูมิของแสงอยู่ที่
2700K - 3000K

WARM WHITE



ให้แสงสีแฉวออกโทนส้ม เป็นโทนสีร้อน โทนอบอุ่น

ค่าอุณหภูมิของแสงอยู่ที่
3500K - 4000K

COOL WHITE



ให้แสงสีออกโทนขาวเหลือง เป็นโทนสีที่ดูเย็นสบายตา ค่อนข้างสว่างกว่า เมื่อเทียบกับ Warm White

ค่าอุณหภูมิของแสงอยู่ที่
5000K - 6500K

DAY LIGHT



ให้แสงสีโทนออกขาวอมฟ้า เป็นโทนสีแสงตอนกลางวัน สว่างสดใส ดังนั้นค่าความถูกต้องของสีจึงมากกว่า เมื่อเทียบกับ Warm White หรือ Cool White

แสงที่เหมาะสมกับห้องต่างๆ ในบ้านคุณ

Day Light
5000K - 6500K

Cool White
3500K - 4000K

Warm White
2700K - 3000K



ห้องน้ำ 3000K 4000K



ห้องนอน 3000K 4000K

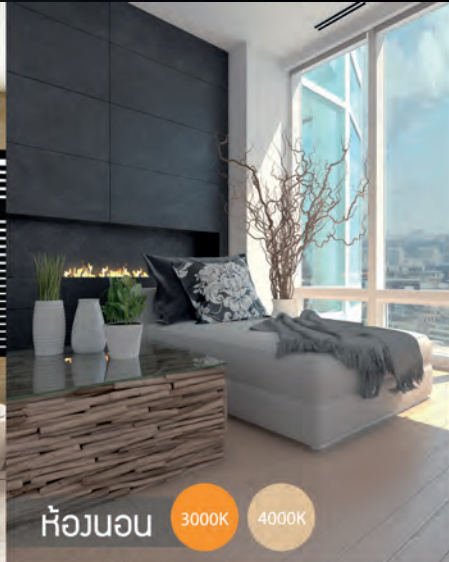

ห้องรับแขก 4000K 6500K



ห้องทำงาน 4000K 6500K











ห้องครัว 3000K 6500K



ที่จอดรถ 4000K 6500K



CONTENT

	PAGE
 FLUORESCENT SERIES	1-24
 LED SERIES	1-20
 SOLAR SERIES	1-5
 HIGH BAY SERIES	1-4
 TRACK LIGHT SERIES	1-4
 DOWNLIGHT SERIES	1-51
 EMERGENCY SERIES	1-7
 CEILING LAMP SERIES	1-6

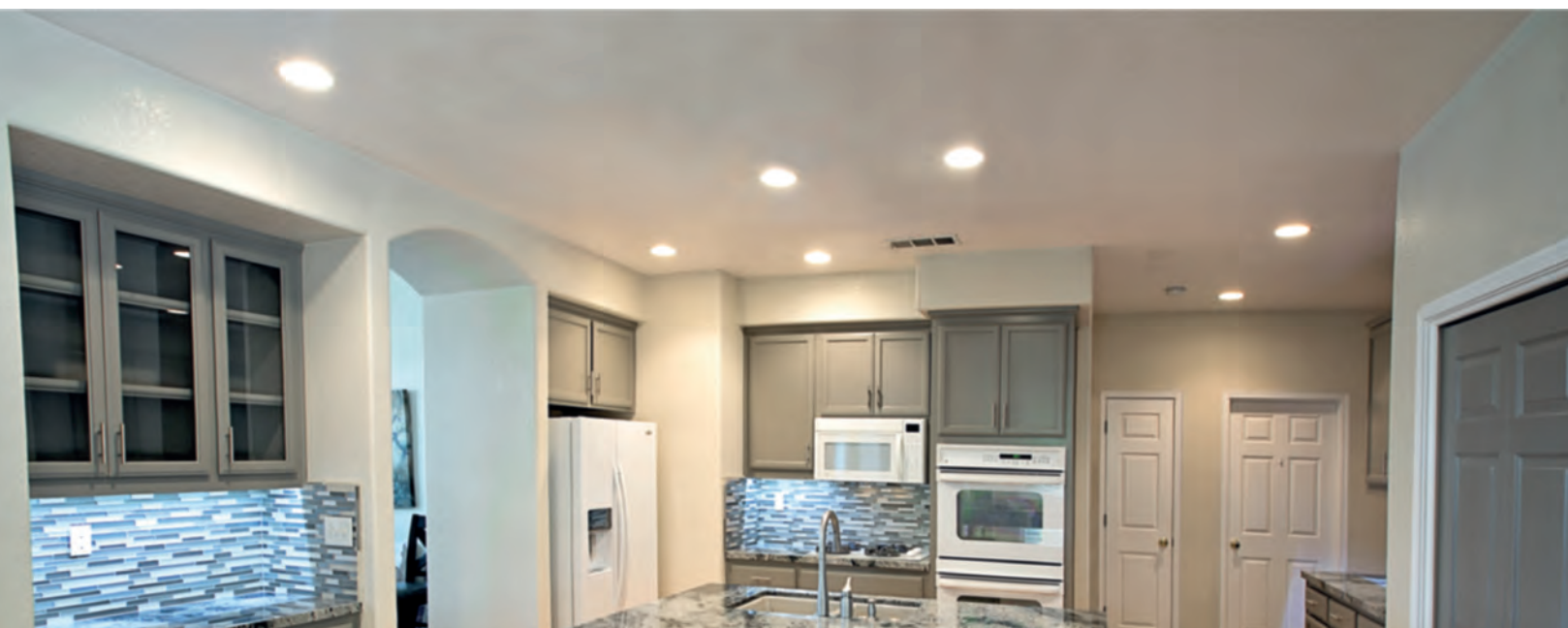



F-LOR

T8 Recessed Louver Luminaire



HOUSING

- MADE OF HIGH QUALITY COLD-ROLLED STEEL SHEET OF THICKNESS 0.6 OR 0.4MM.
- FIVE-STAGE ZINC PHOSPHATE PRETREATMENT FOR RUST RESISTANCE.
- FINISHED WITH WHITE POLYESTER POWDER BY TWO-STAGE ELECTROSTATIC METHOD.
- HEAVY DUTY ROTARY-LOCKED TYPE (G13) LAMP HOLDER (TIS.344-1987 STANDARD)
- ROTARY-LOCKED TYPE STARTER HOLDER (TIS STANDARD)
- CABLE THW (TIS.11-1988 STANDARD)

REFLECTOR & LOUVER

- 99.85% HIGH PURITY ANODIZED ALUMINIUM REFLECTOR WITH TOTAL REFLECTANCE OF 87% (87) MIRROR FINISHED (DIN 5036-2) FOR NORMAL USAGE. OPTIONAL: TR = 95% (95) FOR HIGH EFFICIENCY PURPOSE.
- 99.85% HIGH PURITY ANODIZED ALUMINIUM REFLECTOR WITH TOTAL REFLECTANCE OF 87% (87) MIRROR FINISHED (DIN 5036-2) FOR LONGITUDINAL WITH ALUMINIUM PROFILE TO ANTI-GLARE. STANDARD
- SPRING-LOCK TYPE FOR EASE OF MAINTENANCE.

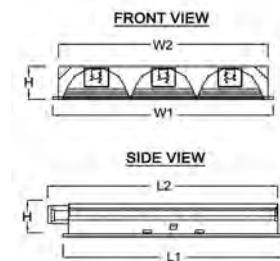

INSTALLATION & APPLICATION

- FOR RECESSED T-BAR AND GYPSUM CEILING INSTALLATION.
- RECOMMENDED FOR COMMERCIAL BUILDINGS, SHOPS, HOSPITALS, DEPARTMENT STORES, SCHOOLS, ETC.



MODEL NO	WATT	DIMENSION (MM.)					CUT OUT (MM.)	REMARK
		L1	L2	W1	W2	H		
F-LOR118	1 X T8 18W.	595	620	200	170	80	575 X 185	
F-LOR118/30	1 X T8 18W	595	620	295	265	80	575 X 275	
F-LOR218	2 X T8 18W.	595	620	295	265	80	575 X 275	
F-LOR218/60	2 X T8 18W.	595	620	595	565	80	575 X 575	
F-LOR318	3 X T8 18W.	595	620	595	565	80	575 X 575	
F-LOR418	4 X T8 18W.	595	620	595	565	80	575 X 575	
F-LOR136	1 X T8 36W.	595	620	595	565	80	1175 X 185	
F-LOR136/30	1 X T8 36W.	1195	1222	200	170	80	1175 X 275	
F-LOR236	2 X T8 36W.	1195	1222	295	265	80	175 X 275	
F-LOR236/60	2 X T8 36W.	1195	1222	595	565	80	1175 X 575	
F-LOR336	3 X T8 36W.	1195	1222	595	565	80	1175 X 575	
F-LOR436	4 X T8 36W.	1195	1222	595	565	80	1175 X 575	



F-LOS

T8 Surface Mounted[®] Louver Luminaire

HOUSING

- MADE OF HIGH QUALITY COLD-ROLLED STEEL SHEET OF THICKNESS 0.6 OR 0.4MM.
- FIVE-STAGE ZINC PHOSPHATE PRETREATMENT FOR RUST RESISTANCE.
- FINISHED WITH WHITE POLYESTER POWDER BY TWO-STAGE ELECTROSTATIC METHOD.
- HEAVY DUTY ROTARY-LOCKED TYPE (G13) LAMP HOLDER (TIS.344-1987 STANDARD)
- ROTARY-LOCKED TYPE STARTER HOLDER (TIS STANDARD)
- CABLE THW (TIS.11-1988 STANDARD)

REFLECTOR & LOUVER

- 99.85% HIGH PURITY ANODIZED ALUMINIUM REFLECTOR WITH TOTAL REFLECTANCE OF 87% (87) MIRROR FINISHED (DIN 5036-2) FOR NORMAL USAGE. OPTIONAL: TR = 95% (95) FOR HIGH EFFICIENCY PURPOSE.
- 99.85% HIGH PURITY ANODIZED ALUMINIUM REFLECTOR WITH TOTAL REFLECTANCE OF 87% (87) MIRROR FINISHED (DIN 5036-2) FOR LONGITUDINAL WITH ALUMINIUM PROFILE TO ANTI-GLARE. STANDARD
- SPRING-LOCK TYPE FOR EASE OF MAINTENANCE.

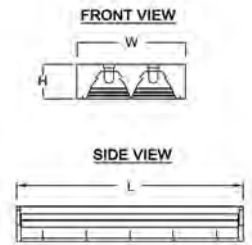

INSTALLATION & APPLICATION

- FOR SURFACE MOUNTED OR SUSPENSION ROD INSTALLATION
- RECOMMENDED FOR COMMERCIAL BUILDINGS, SHOPS, HOSPITALS, DEPARTMENT STORES, SCHOOLS, ETC.

MODEL NO	WATT	DIMENSION (MM.)			REMARK
		L	W	H	
F-LOS118	1 X T8 18W.	615	200	80	
F-LOS118/30	1 X T8 18W	615	295	80	
F-LOS218	2 X T8 18W.	615	295	80	
F-LOS218/60	2 X T8 18W.	615	595	80	
F-LOS318	3 X T8 18W.	615	595	80	
F-LOS418	4 X T8 18W.	615	595	80	
F-LOS136	1 X T8 36W.	1222	200	80	
F-LOS136/30	1 X T8 36W.	1222	295	80	
F-LOS236	2 X T8 36W.	1222	295	80	
F-LOS236/60	2 X T8 36W.	1222	595	80	
F-LOS336	3 X T8 36W.	1222	595	80	
F-LOS436	4 X T8 36W.	1222	595	80	



F-LORP

T8 Recessed Acrylic Diffuser Luminaire



HOUSING

- MADE OF HIGH QUALITY COLD-ROLLED STEEL SHEET OF THICKNESS 0.6 OR 0.4MM.
- FIVE-STAGE ZINC PHOSPHATE PRETREATMENT FOR RUST RESISTANCE.
- FINISHED WITH WHITE POLYESTER POWDER BY TWO-STAGE ELECTROSTATIC METHOD.
- HEAVY DUTY ROTARY-LOCKED TYPE (G13) LAMP HOLDER (TIS.344-1987 STANDARD)
- ROTARY-LOCKED TYPE STARTER HOLDER (TIS STANDARD)
- CABLE THW (TIS.11-1988 STANDARD)

REFLECTOR & LOUVER

- HIGH QUALITY ACRYLIC DIFFUSER WITH STEEL PAINTED FRAME. FOUR ACRYLIC DIFFUSERS ARE AVAILABLE: PRISMATIC, OPAL, STIPPLE, AND CLEAR
- 99.85% HIGH PURITY ANODIZED ALUMINIUM REFLECTANCE WITH TOTAL REFLECTANCE OF 87% (87 FOR NORMAL USAGE. OPTIONAL: TOTAL REFLECTANCE OF 95% (95) FOR HIGH EFFICIENCY PURPOSE.
- SPRING-LOCK TYPE FOR EASE OF MAINTENANCE.

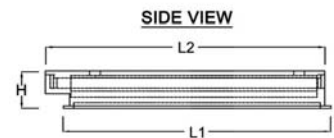
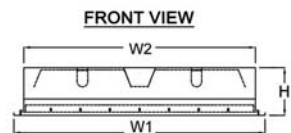

INSTALLATION & APPLICATION

- FOR RECESSED T-BAR AND GYPSUM CEILING INSTALLATION.
- RECOMMENDED FOR COMMERCIAL BUILDINGS, HOSPITALS, LABORATORIES, SCHOOLS, ETC.



MODEL NO	WATT	DIMENSION (MM.)					CUT OUT (MM.)	REMARK
		L1	L2	W1	W2	H		
F-LORP118	1 X T8 18W.	595	620	200	170	100	575 X 185	
F-LORP118/30	1 X T8 18W	595	620	295	265	100	575 X 275	
F-LORP218	2 X T8 18W.	595	620	295	265	100	575 X 275	
F-LORP218/60	2 X T8 18W.	595	620	595	565	100	575 X 575	
F-LORP318	3 X T8 18W.	595	620	595	565	100	575 X 575	
F-LORP418	4 X T8 18W.	595	620	595	565	100	575 X 575	
F-LORP136	1 X T8 36W.	595	620	595	565	100	1175 X 185	
F-LORP136/30	1 X T8 36W.	1195	1222	200	170	100	1175 X 275	
F-LORP236	2 X T8 36W.	1195	1222	295	265	100	175 X 275	
F-LORP236/60	2 X T8 36W.	1195	1222	595	565	100	1175 X 575	
F-LORP336	3 X T8 36W.	1195	1222	595	565	100	1175 X 575	
F-LORP436	4 X T8 36W.	1195	1222	595	565	100	1175 X 575	

B = ACRYLIC TYPE (PR, OP, ST, CL)

A = REFLECTANCE OF ALUMINIUM REFLECTOR (87=87% , 95=95%)

កាំរស្មី គឺ ប្លង់ REFLECTOR



F-LOSP

T8 Surface Mounted Acrylic Diffuser Luminaire



- MADE OF HIGH QUALITY COLD-ROLLED STEEL SHEET OF THICKNESS 0.6 OR 0.4MM.
- FIVE-STAGE ZINC PHOSPHATE PRETREATMENT FOR RUST RESISTANCE.
- FINISHED WITH WHITE POLYESTER POWDER BY TWO-STAGE ELECTROSTATIC METHOD.
- HEAVY DUTY ROTARY-LOCKED TYPE (G13) LAMP HOLDER (TIS.344-1987 STANDARD)
- ROTARY-LOCKED TYPE STARTER HOLDER (TIS STANDARD)
- CABLE THW (TIS.11-1988 STANDARD)

REFLECTOR & LOUVER

- HIGH QUALITY ACRYLIC DIFFUSER WITH STEEL PAINTED FRAME. FOUR ACRYLIC DIFFUSERS ARE AVAILABLE: PRISMATIC, OPAL, STIPPLE, AND CLEAR
- 99.85% HIGH PURITY ANODIZED ALUMINIUM REFLECTANCE WITH TOTAL REFLECTANCE OF 87% (87 FOR NORMAL USAGE. OPTIONAL: TOTAL REFLECTANCE OF 95% (95) FOR HIGH EFFICIENCY PURPOSE.

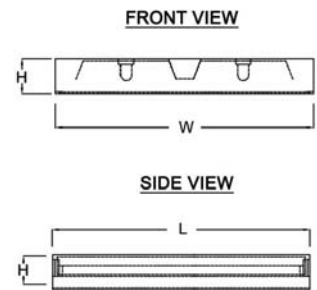

INSTALLATION & APPLICATION

- FOR SURFACE MOUNTED OR SUSPENSION ROD INSTALLATION
- RECOMMENDED FOR COMMERCIAL BUILDINGS, HOSPITALS, LABORATORIES, SCHOOLS, ETC.

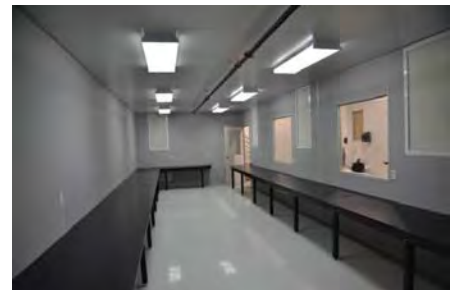

MODEL NO	WATT	DIMENSION (MM.)			REMARK
		L	W	H	
F-LOSP118	1 X T8 18W.	615	200	82	
F-LOSP118/30	1 X T8 18W	615	295	82	
F-LOSP218	2 X T8 18W.	615	295	82	
F-LOSP218/60	2 X T8 18W.	615	595	82	
F-LOSP318	3 X T8 18W.	615	595	82	
F-LOSP418	4 X T8 18W.	615	595	82	
F-LOSP136	1 X T8 36W.	1222	200	82	
F-LOSP136/30	1 X T8 36W.	1222	295	82	
F-LOSP236	2 X T8 36W.	1222	295	82	
F-LOSP236/60	2 X T8 36W.	1222	595	82	
F-LOSP336	3 X T8 36W.	1222	595	82	
F-LOSP436	4 X T8 36W.	1222	595	82	

B = ACRYLIC TYPE (PR, OP, ST, CL)

A = REFLECTANCE OF ALUMINIUM REFLECTOR (87=87% , 95=95%)

កាំប៉ង គឺ ប៉ង REFLECTOR



F-LORT5

T5 Recessed Louver Luminaire

HOUSING

- MADE OF HIGH QUALITY COLD-ROLLED STEEL SHEET OF THICKNESS 0.6 OR 0.4MM.
- FIVE-STAGE ZINC PHOSPHATE PRETREATMENT FOR RUST RESISTANCE.
- FINISHED WITH WHITE POLYESTER POWDER BY TWO-STAGE ELECTROSTATIC METHOD.
- HEAVY DUTY ROTARY-LOCKED TYPE (G13) LAMP HOLDER (TIS.344-1987 STANDARD)
- CABLE THW (TIS.11-1988 STANDARD)

REFLECTOR & LOUVER

- 99.85% HIGH PURITY ANODIZED ALUMINIUM REFLECTOR WITH TOTAL REFLECTANCE OF 87% (87) MIRROR FINISHED (DIN 5036-2) FOR NORMAL USAGE. OPTIONAL: TR = 95% (95) FOR HIGH EFFICIENCY PURPOSE.
- 99.85% HIGH PURITY ANODIZED ALUMINIUM REFLECTOR WITH TOTAL REFLECTANCE OF 87% (87) MIRROR FINISHED (DIN 5036-2) FOR LONGITUDINAL WITH ALUMINIUM PROFILE TO ANTI-GLARE. STANDARD
- SPRING-LOCK TYPE FOR EASE OF MAINTENANCE.

FRONT VIEW

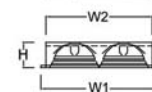

SIDE VIEW

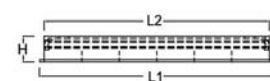

INSTALLATION & APPLICATION

- FOR RECESSED T-BAR AND GYPSUM CEILING INSTALLATION.
- RECOMMENDED FOR COMMERCIAL BUILDINGS, SHOPS, HOSPITALS, DEPARTMENT STORES, SCHOOLS, ETC.



MODEL NO	WATT	DIMENSION (MM.)					CUT OUT (MM.)	REMARK
		L1	L2	W1	W2	H		
F-LORT5-114	1 X T5 14W.	595	570	200	170	65	575 X 185	
F-LORT5-114/30	1 X T5 14W.	595	570	295	270	65	575 X 275	
F-LORT5-214	2 X T5 14W.	595	570	295	270	65	575 X 275	
F-LORT5-214/60	2 X T5 14W.	595	570	595	570	65	575 X 575	
F-LORT5-314	3 X T5 14W..	595	570	595	570	65	575 X 575	
F-LORT5-414	4 X T5 14W.	595	570	595	570	65	575 X 575	
F-LORT5-128	1 X T5 28W.	1195	1170	200	170	65	1175 X 185	
F-LORT5-128/30	1 X T5 28W.	1195	1170	295	270	65	1175 X 275	
F-LORT5-228	2 X T5 28W.	1195	1170	295	270	65	1175 X 275	
F-LORT5-228/60	2 X T5 28W.	1195	1170	595	570	65	1175 X 575	
F-LORT5-328	3 X T5 28W.	1195	1170	595	570	65	1175 X 575	
F-LORT5-428	4 X T5 28W.	1195	1170	595	570	65	1175 X 575	



F-LOST5

T5 Surface Mounted Louver Luminaire

HOUSING

- MADE OF HIGH QUALITY COLD-ROLLED STEEL SHEET OF THICKNESS 0.6 OR 0.4MM.
- FIVE-STAGE ZINC PHOSPHATE PRETREATMENT FOR RUST RESISTANCE.
- FINISHED WITH WHITE POLYESTER POWDER BY TWO-STAGE ELECTROSTATIC METHOD.
- HEAVY DUTY ROTARY-LOCKED TYPE (G13) LAMP HOLDER (TIS.344-1987 STANDARD)
- CABLE THW (TIS.11-1988 STANDARD)

REFLECTOR & LOUVER

- 99.85% HIGH PURITY ANODIZED ALUMINIUM REFLECTOR WITH TOTAL REFLECTANCE OF 87% (87) MIRROR FINISHED (DIN 5036-2) FOR NORMAL USAGE. OPTIONAL: TR = 95% (95) FOR HIGH EFFICIENCY PURPOSE.
- 99.85% HIGH PURITY ANODIZED ALUMINIUM REFLECTOR WITH TOTAL REFLECTANCE OF 87% (87) MIRROR FINISHED (DIN 5036-2) FOR LONGITUDINAL WITH ALUMINIUM PROFILE TO ANTI-GLARE. STANDARD
- SPRING-LOCK TYPE FOR EASE OF MAINTENANCE.

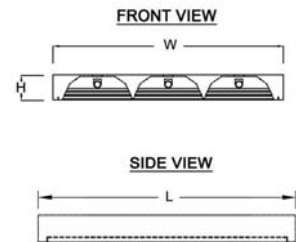

INSTALLATION & APPLICATION

- FOR SURFACE MOUNTED OR SUSPENSION ROD INSTALLATION
- RECOMMENDED FOR COMMERCIAL BUILDINGS, SHOPS, HOSPITALS, DEPARTMENT STORES, SCHOOLS, ETC.



MODEL NO	WATT	DIMENSION (MM.)			REMARK
		L	W	H	
F-LOST5-114	1 X T5 14W.	615	200	65	
F-LOST5-114/30	1 X T5 14W.	615	295	65	
F-LOST5-214	2 X T5 14W.	615	295	65	
F-LOST5-214/60	2 X T5 14W.	615	595	65	
F-LOST5-314	3 X T5 14W..	615	595	65	
F-LOST5-414	4 X T5 14W.	615	595	65	
F-LOST5-128	1 X T5 28W.	1222	200	65	
F-LOST5-128/30	1 X T5 28W.	1222	295	65	
F-LOST5-228	2 X T5 28W.	1222	295	65	
F-LOST5-228/60	2 X T5 28W.	1222	595	65	
F-LOST5-328	3 X T5 28W.	1222	595	65	
F-LOST5-428	4 X T5 28W.	1222	595	65	



F-LORPT5

T5 Recessed Acrylic Diffuser Luminaire



HOUSING

- MADE OF HIGH QUALITY COLD-ROLLED STEEL SHEET OF THICKNESS 0.6 OR 0.4MM
- FIVE-STAGE ZINC PHOSPHATE PRETREATMENT FOR RUST RESISTANCE.
- FINISHED WITH WHITE POLYESTER POWDER BY TWO-STAGE ELECTROSTATIC METHOD.
- HEAVY DUTY ROTARY-LOCKED TYPE (G13) LAMP HOLDER (TIS.344-1987 STANDARD)
- CABLE THW (TIS.11-1988 STANDARD)

REFLECTOR & LOUVER

- HIGH QUALITY ACRYLIC DIFFUSER WITH STEEL PAINTED FRAME. FOUR ACRYLIC DIFFUSERS ARE AVAILABLE: PRISMATIC, OPAL, STIPPLE, AND CLEAR
- 99.85% HIGH PURITY ANODIZED ALUMINIUM REFLECTANCE WITH TOTAL REFLECTANCE OF 87% (87 FOR NORMAL USAGE. OPTIONAL: TOTAL REFLECTANCE OF 95% (95) FOR HIGH EFFICIENCY PURPOSE.
- SPRING-LOCK TYPE FOR EASE OF MAINTENANCE.

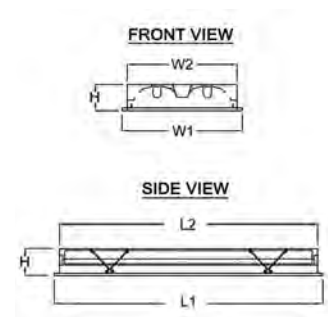

INSTALLATION & APPLICATION

- FOR RECESSED T-BAR AND GYPSUM CEILING INSTALLATION.
- RECOMMENDED FOR COMMERCIAL BUILDINGS, HOSPITALS, LABORATORIES, SCHOOLS, ETC.



MODEL NO	WATT	DIMENSION (MM.)					CUT OUT (MM.)	REMARK
		L1	L2	W1	W2	H		
F-LORPT5-114	1 X T5 14W.	595	570	200	170	65	575 X 185	
F-LORPT5-114/30	1 X T5 14W.	595	570	295	270	65	575 X 275	
F-LORPT5-214	2 X T5 14W.	595	570	295	270	65	575 X 275	
F-LORPT5-214/60	2 X T5 14W.	595	570	595	570	65	575 X 575	
F-LORPT5-314	3 X T5 14W..	595	570	595	570	65	575 X 575	
F-LORPT5-414	4 X T5 14W.	595	570	595	570	65	575 X 575	
F-LORPT5-128	1 X T5 28W.	1195	1170	200	170	65	1175 X 185	
F-LORPT5-128/30	1 X T5 28W.	1195	1170	295	270	65	1175 X 275	
F-LORPT5-228	2 X T5 28W.	1195	1170	295	270	65	1175 X 275	
F-LORPT5-228/60	2 X T5 28W.	1195	1170	595	570	65	1175 X 575	
F-LORPT5-328	3 X T5 28W.	1195	1170	595	570	65	1175 X 575	
F-LORPT5-428	4 X T5 28W.	1195	1170	595	570	65	1175 X 575	

B = ACRYLIC TYPE (PR, OP, ST, CL)

A = REFLECTANCE OF ALUMINIUM REFLECTOR (87=87% , 95=95%)

កាំរស្មី គឺ ប្លង់ REFLECTOR



F-LOSPT5

T5 Surface Mounted Acrylic Diffuser Luminaire



HOUSING

- MADE OF HIGH QUALITY COLD-ROLLED STEEL SHEET OF THICKNESS 0.6 OR 0.4MM.
- FIVE-STAGE ZINC PHOSPHATE PRETREATMENT FOR RUST RESISTANCE.
- FINISHED WITH WHITE POLYESTER POWDER BY TWO-STAGE ELECTROSTATIC METHOD.
- HEAVY DUTY ROTARY-LOCKED TYPE (G13) LAMP HOLDER (TIS.344-1987 STANDARD)
- CABLE THW (TIS.11-1988 STANDARD)

REFLECTOR & LOUVER

- HIGH QUALITY ACRYLIC DIFFUSER WITH STEEL PAINTED FRAME. FOUR ACRYLIC DIFFUSERS ARE AVAILABLE: PRISMATIC, OPAL, STIPPLE, AND CLEAR
- 99.85% HIGH PURITY ANODIZED ALUMINIUM REFLECTANCE WITH TOTAL REFLECTANCE OF 87% (87 FOR NORMAL USAGE. OPTIONAL: TOTAL REFLECTANCE OF 95% (95) FOR HIGH EFFICIENCY PURPOSE.

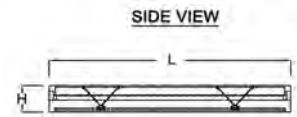
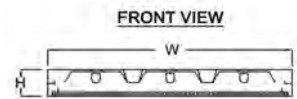

INSTALLATION & APPLICATION

- FOR SURFACE MOUNTED OR SUSPENSION ROD INSTALLATION
- RECOMMENDED FOR COMMERCIAL BUILDINGS, HOSPITALS, LABORATORIES, SCHOOLS, ETC.



MODEL NO	WATT	DIMENSION (MM.)			REMARK
		L	W	H	
F-LOSPT5-114	1 X T5 14W.	595	200	65	
F-LOSPT5-114/30	1 X T5 14W.	595	295	65	
F-LOSPT5-214	2 X T5 14W.	595	295	65	
F-LOSPT5-214/60	2 X T5 14W.	595	595	65	
F-LOSPT5-314	3 X T5 14W..	595	595	65	
F-LOSPT5-414	4 X T5 14W.	595	595	65	
F-LOSPT5-128	1 X T5 28W.	1200	200	65	
F-LOSPT5-128/30	1 X T5 28W.	1200	295	65	
F-LOSPT5-228	2 X T5 28W.	1200	295	65	
F-LOSPT5-228/60	2 X T5 28W.	1200	595	65	
F-LOSPT5-328	3 X T5 28W.	1200	595	65	
F-LOSPT5-428	4 X T5 28W.	1200	595	65	

B = ACRYLIC TYPE (PR, OP, ST, CL)

A = REFLECTANCE OF ALUMINIUM REFLECTOR (87=87% , 95=95%)

កាំប៉ង គឺ ប៉ង REFLECTOR

F-LASR

Recess Air Supply Louver Luminaire

- MADE OF HIGH QUALITY COLD-ROLLED STEEL SHEET OF THICKNESS 0.6
- FIVE-STAGE ZINC PHOSPHATE PRETREATMENT FOR RUST RESISTANCE.
- FINISHED WITH WHITE POLYESTER POWDER BY TWO-STAGE ELECTROSTATIC METHOD.
- HEAVY DUTY ROTARY-LOCKED TYPE (G13) LAMP HOLDER (TIS.344-1987 STANDARD)
- ROTARY-LOCKED TYPE STARTER HOLDER (TIS.344-1987 STANDARD)
- 99.85% HIGH PURITY ANODIZED ALUMINIUM REFLECTOR WITH TOTAL REFLECTANCE OF 87% (87) FOR NORMAL USAGE WITH ALUMINIUM PROFILE TO ANTI-GLARE.
- HIGH QUALITY ALUMINIUM EXTRUDED AIR SLOTS TO SUPPLY AIR FLOW.
- SPRING-LOCK TYPE FRAME FOR EASE OF MAINTENANCE



MODEL NO	WATT	DIMENSION (MM.)					CUT OUT (MM.)
		L1	L2	W1	W2	H	
F-LASR218/60	2 X T8 18W.	595	615	595	425	90	575 X 575
F-LASR318	3 X T8 18W.	595	615	595	425	90	575 X 575
F-LASR236/60	2 X T8 36W.	1195	1222	595	425	90	1175 X 575
F-LASR336	3 X T8 36W.	1195	1222	595	425	90	1175 X 575

F-LARR

Recess Air Return Louver Luminaire

- MADE OF HIGH QUALITY COLD-ROLLED STEEL SHEET OF THICKNESS 0.6
- FIVE-STAGE ZINC PHOSPHATE PRETREATMENT FOR RUST RESISTANCE.
- FINISHED WITH WHITE POLYESTER POWDER BY TWO-STAGE ELECTROSTATIC METHOD.
- HEAVY DUTY ROTARY-LOCKED TYPE (G13) LAMP HOLDER (TIS.344-1987 STANDARD)
- ROTARY-LOCKED TYPE STARTER HOLDER (TIS.344-1987 STANDARD)
- 99.85% HIGH PURITY ANODIZED ALUMINIUM REFLECTOR WITH TOTAL REFLECTANCE OF 87% (87) FOR NORMAL USAGE WITH ALUMINIUM PROFILE TO ANTI-GLARE.
- HIGH QUALITY STEEL PAINTED AIR RETURN SLOTS.
- SPRING-LOCK TYPE FRAME FOR EASE OF MAINTENANCE.

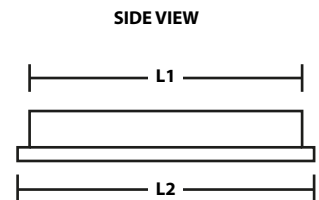
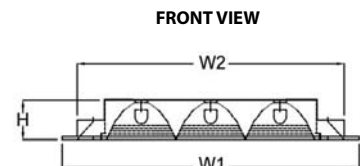

MODEL NO	WATT	DIMENSION (MM.)					CUT OUT (MM.)
		L1	L2	W1	W2	H	
F-LARR218/60	2 X T8 18W.	595	615	595	425	90	575 X 575
F-LARR318	3 X T8 18W.	595	615	595	425	90	575 X 575
F-LARR236/60	2 X T8 36W.	1195	1222	595	425	90	1175 X 575
F-LARR336	3 X T8 36W.	1195	1222	595	425	90	1175 X 575



F-HB

T8 Acrylic Diffuser Type Fluorescent High Bay

HOUSING

- MADE OF HIGH QUALITY COLD-ROLLED STEEL SHEET OF THICKNESS 0.6
- FIVE-STAGE ZINC PHOSPHATE PRETREATMENT FOR RUST RESISTANCE.
- FINISHED WITH WHITE POLYESTER POWDER BY TWO-STAGE ELECTROSTATIC METHOD.
- HEAVY DUTY ROTARY-LOCKED TYPE (G13) LAMP HOLDER (TIS.344-1987 STANDARD)
- CABLE THW (TIS.11-1988 STANDARD)

REFLECTOR & LOUVER

- 99.85% HIGH PURITY ANODIZED ALUMINIUM REFLECTOR WITH TOTAL REFLECTANCE OF 87% (87) MIRROR FINISHED (DIN 5036-2) FOR NORMAL USAGE. OPTIONAL: TR = 95% (95) FOR HIGH EFFICIENCY PURPOSE.
- HIGH QUALITY ACRYLIC DIFFUSER WITH STEEL PAINTED FRAME. FOUR ACRYLIC DIFFUSERS ARE AVAILABLE: PRISMATIC, OPAL, STIPPLE, AND CLEAR
- PAINTED STEEL FRAME WITH STAINLESS CLIP-LOCK TYPE FOR EASE OF MAINTENANCE
- WEATHER PROOF GASKET SEAL FOR HIGHER PREVENTION (OPTIONAL).
- WIRE GURAD COVER (OPTIONAL).

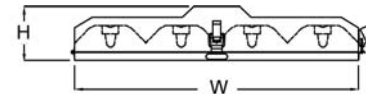

INSTALLATION & APPLICATION

- FOR SURFACE MOUNTED OR SUSPENSION ROD INSTALLATION
- RECOMMENDED FOR WAREHOUSES, FACTORIES, ETC.



OPTIONAL: WIRE GUARD COVER



MODEL NO	WATT	DIMENSION (MM.)			REMARK
		L	W	H	
F-HB336	3 X T8 36W.	1222	400	90	
F-HB436	4 X T8 36W.	1222	400	90	

B = ACRYLIC TYPE (PR, OP, ST, CL)

A = REFLECTANCE OF ALUMINIUM REFLECTOR (87=87%)

កាំរស្មី គឺ ប្លង់ REFLECTOR

F-CURVE 1

Recessed Mounted Luminaire

- MADE OF HIGH QUALITY COLD-ROLLED STEEL SHEET OF THICKNESS 0.6 (T6)
- FIVE-STAGE ZINC PHOSPHATE PRETREATMENT FOR RUST RESISTANCE.
- FINISHED WITH WHITE POLYESTER POWDER BY TWO-STAGE ELECTROSTATIC METHOD.
- HEAVY DUTY ROTARY-LOCKED TYPE (TIS.344-1987 STANDARD)
- SPRING-LOCK TYPE FRAME FOR EASE OF MAINTENANCE.



MODEL NO	WATT	DIMENSION (MM.)					CUT OUT (MM.)
		L1	L2	W1	W2	H	
F-CURVE1-218F	2 X T8 18W.	620	595	595	565	115	575 X 575
F-CURVE1-236PL	3 X PLL 36W.	595	565	595	565	115	575 X 575
F-CURVE1-236F	2 X T8 36W.	1220	1995	595	565	115	1172 X 575

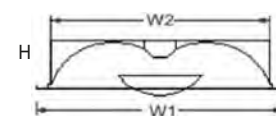

F-CURVE-V

Recessed Mounted Louver Luminaire

HOUSING

- MADE OF HIGH QUALITY COLD-ROLLED STEEL SHEET OF THICKNESS 0.6 (T6).
- FIVE-STAGE ZINC PHOSPHATE PRETREATMENT FOR RUST RESISTANCE.
- FINISHED WITH WHITE POLYESTER POWDER BY TWO-STAGE ELECTROSTATIC METHOD.
- HEAVY DUTY ROTARY-LOCKED TYPE (G13) LAMP HOLDER (TIS.344-1987 STANDARD)

REFLECTOR & LOUVER

- 99.85% HIGH PURITY ANODIZED ALUMINIUM REFLECTOR WITH TOTAL REFLECTANCE OF 87% (87) FOR NORMAL USAGE.
- SPRING-LOCK TYPE LOUVER FOR EASE OF MAINTENANCE.



MODEL NO	WATT	DIMENSION (MM.)					CUT OUT (MM.)
		L1	L2	W1	W2	H	
F-CURVE-V-218F	2 X T8 18W.	620	595	595	565	100	605 X 580
F-CURVE-V-236F	2 X T8 16W.	1220	1195	595	565	100	1205 X 575
F-CURVE-V-236PLL	2 X PLL 36W.	620	570	595	565	100	580 X 605

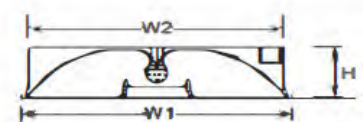

F-FRAME

Recessed Mounted with Downlight Luminaire

- MADE OF HIGH QUALITY COLD-ROLLED STEEL SHEET OF THICKNESS 0.6 (T6)
- FIVE-STAGE ZINC PHOSPHATE PRETREATMENT FOR RUST RESISTANCE.
- FINISHED WITH WHITE POLYESTER POWDER BY TWO-STAGE ELECTROSTATIC METHOD.
- HEAVY DUTY ROTARY-LOCKED TYPE (TIS.344-1987 STANDARD)
- DUAL QR111 DOWNLIGHT ON BOTH END (OPTIONAL: OTHER DOWNLIGHTS ARE AVAILABLE UPON REQUEST)
- 99.85% HIGH PURITY ANODIZED ALUMINIUM REFLECTOR WITH TOTAL REFLECTANCE OF 87%(87)
- OPAL ACRYLIC DIFFUSER FOR SMOOTH LIGHT DISTRIBUTION

MODEL NO	WATT	DIMENSION (MM.)				
		L1	L2	W1	W2	H
F-FRAME136/QR	1 X T8 36W.	1646	1622	206	180	140
F-FRAME236/QR	2 X T8 36W.	1646	1622	206	180	140



F-DOUBLE

Recessed Mounted with Downlight Luminaire

- MADE OF HIGH QUALITY COLD-ROLLED STEEL SHEET OF THICKNESS 0.6 (T6)
- FIVE-STAGE ZINC PHOSPHATE PRETREATMENT FOR RUST RESISTANCE.
- FINISHED WITH WHITE POLYESTER POWDER BY TWO-STAGE ELECTROSTATIC METHOD.
- HEAVY DUTY ROTARY-LOCKED TYPE (TIS.344-1987 STANDARD)
- DUAL G12 DOWNLIGHT ON BOTH END (OPTIONAL: OTHER DOWNLIGHTS ARE AVAILABLE UPON REQUEST)
- 99.85% HIGH PURITY ANODIZED ALUMINIUM REFLECTOR WITH TOTAL REFLECTANCE OF 87%(87)
- OPAL ACRYLIC DIFFUSER FOR SMOOTH LIGHT DISTRIBUTION

MODEL NO	WATT	DIMENSION (MM.)				
		L1	L2	W1	W2	H
F-DOUBLE136/G12	1 X T8 36W.	1646	1622	206	180	140
F-DOUBLE236/G12	2 X T8 36W.	1646	1622	206	180	140



ORDERING DATA : F-UBT5_/C C = ACRYLIC TYPE (PR=PRISMATIC, OP=OPAL ST =STIPPLE, CL=CLEAR)

F-LINES

Slim Pendant Louver Luminaire

- MADE OF HIGH QUALITY COLD-ROLLED STEEL SHEET OF THICKNESS 0.6 (T6)
- FIVE-STAGE ZINC PHOSPHATE PRETREATMENT FOR RUST RESISTANCE.
- FINISHED WITH WHITE POLYESTER POWDER BY TWO-STAGE ELECTROSTATIC METHOD.
- HEAVY DUTY ROTARY-LOCKED TYPE (TIS.344-1987 STANDARD)
- 99.85% HIGH PURITY ANODIZED ALUMINIUM REFLECTOR WITH TOTAL REFLECTANCE OF 87% (87) FOR NORMAL USAGE.
- SPRING-LOCK TYPE LOUVER FOR EASE OF MAINTENANCE.

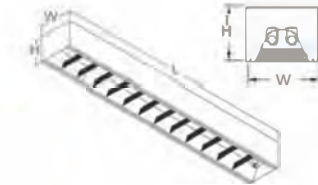

MODEL NO	WATT	DIMENSION (MM.)		
		L	W	H
F-LINES-136	1 X T8 36W.	1245	120	130
F-LINES-236	2 X T8 36W.	1245	150	130

F-LINER

Slim Recessed Mounted Louver Luminaire

- MADE OF HIGH QUALITY COLD-ROLLED STEEL SHEET OF THICKNESS 0.6 (T6)
- FIVE-STAGE ZINC PHOSPHATE PRETREATMENT FOR RUST RESISTANCE.
- FINISHED WITH WHITE POLYESTER POWDER BY TWO-STAGE ELECTROSTATIC METHOD.
- HEAVY DUTY ROTARY-LOCKED TYPE (TIS.344-1987 STANDARD)
- 99.85% HIGH PURITY ANODIZED ALUMINIUM REFLECTOR WITH TOTAL REFLECTANCE OF 87% (87) FOR NORMAL USAGE.
- SPRING-LOCK TYPE LOUVER FOR EASE OF MAINTENANCE.

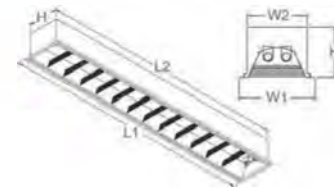

MODEL NO	WATT	DIMENSION (MM.)				
		L1	L2	W1	W2	H
F-LINER-136	1 X T8 36W.	1270	1245	150	120	130
F-LINER-236	2 X T8 36W.	1270	1245	180	150	130



F-HL-SLIM/P

Pendant Acrylic Luminaire

- MADE OF HIGH QUALITY COLD-ROLLED STEEL SHEET OF THICKNESS 0.6 (T6)
- FIVE-STAGE ZINC PHOSPHATE PRETREATMENT FOR RUST RESISTANCE.
- FINISHED WITH WHITE POLYESTER POWDER BY TWO-STAGE ELECTROSTATIC METHOD.
- HEAVY DUTY ROTARY-LOCKED TYPE (TIS.344-1987 STANDARD)
- OPAL ACRYLIC DIFFUSER FOR SMOOTH LIGHT DISTRIBUTION

MODEL NO	WATT	DIMENSION (MM.)		
		L	W	H
F-HL-SLIM120/P	1 X T8 LED	1245	100	100
F-HL-SLIM220/P	2 X T8 LED	1245	150	100

สไลด์ 1 เมตร

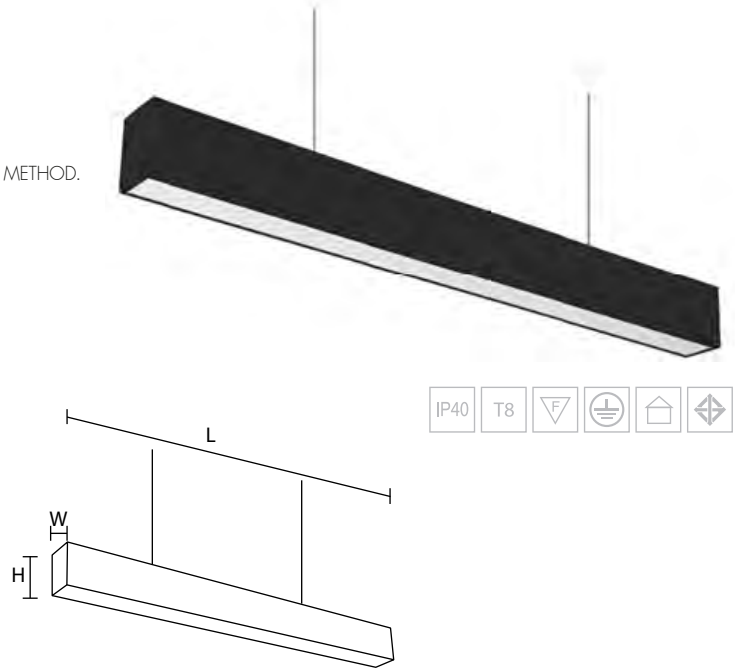

F-RS-SLIM/P

T8 Recessed Acrylic Diffuser Luminaire

- MADE OF HIGH QUALITY COLD-ROLLED STEEL SHEET OF THICKNESS 0.6 (T6)
- FIVE-STAGE ZINC PHOSPHATE PRETREATMENT FOR RUST RESISTANCE.
- FINISHED WITH WHITE POLYESTER POWDER BY TWO-STAGE ELECTROSTATIC METHOD.
- HEAVY DUTY ROTARY-LOCKED TYPE (TIS.344-1987 STANDARD)
- OPAL ACRYLIC DIFFUSER FOR SMOOTH LIGHT DISTRIBUTION

MODEL NO	WATT	DIMENSION (MM.)				
		L1	L2	W1	W2	H
F-RS-SLIM120/P	1 X T8 LED	1265	1245	100	85	100
F-RS-SLIM220/P	2 X T8 LED	1265	1245	150	130	100

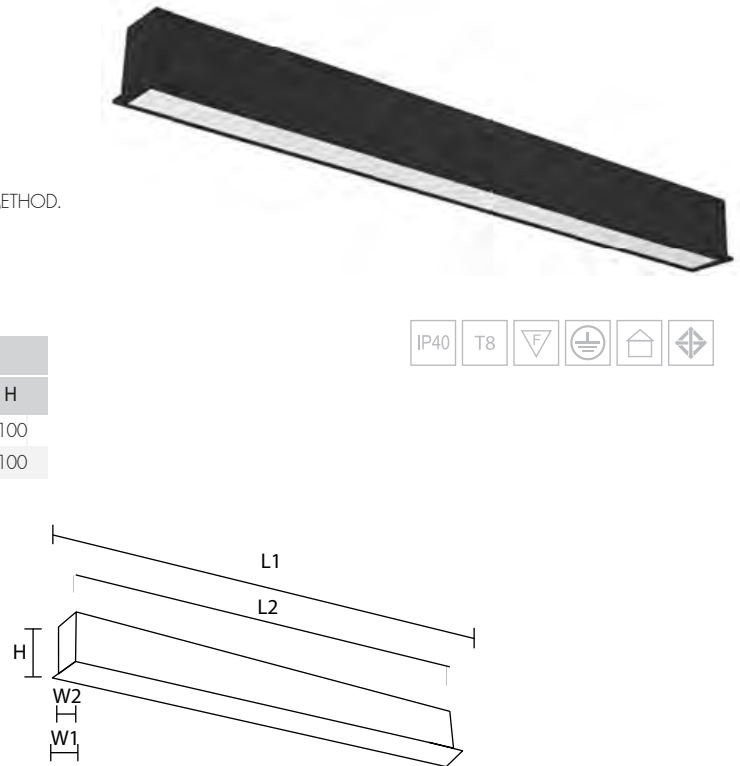

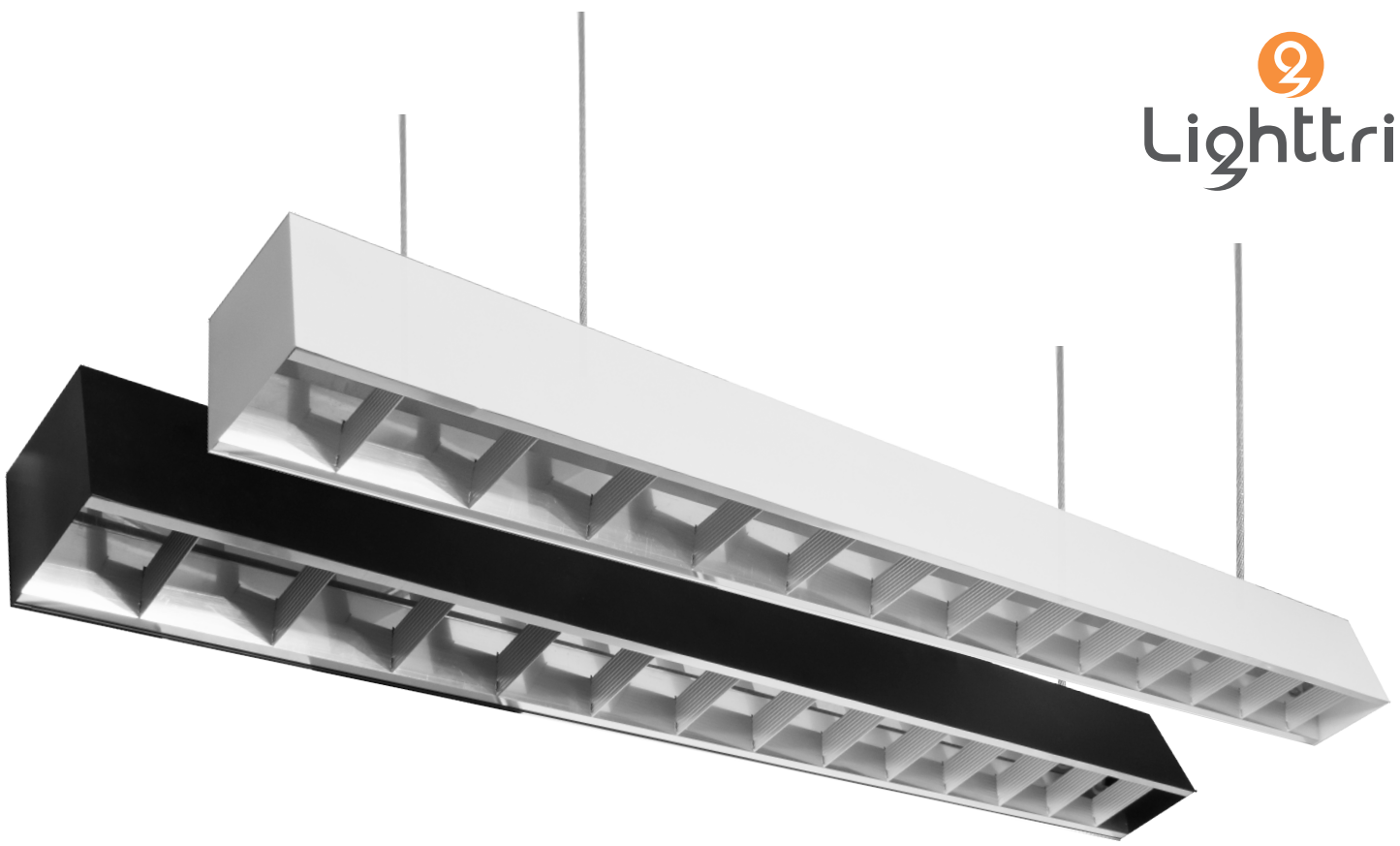

F-HL-SLIM/L

Pendant Louver Luminaire

- MADE OF HIGH QUALITY COLD-ROLLED STEEL SHEET OF THICKNESS 0.6 (T6)
- FIVE-STAGE ZINC PHOSPHATE PRETREATMENT FOR RUST RESISTANCE.
- FINISHED WITH WHITE POLYESTER POWDER BY TWO-STAGE ELECTROSTATIC METHOD.
- HEAVY DUTY ROTARY-LOCKED TYPE (TIS.344-1987 STANDARD)
- 99.85%(87) HIGH PURITY ANODIZED ALUMINIUM REFLECTOR WITH TOTAL REFLECTANCE OF 87%(87) FOR NORMAL USAGE.
- SPRING-LOCK TYPE LOUVER FOR EASE OF MAINTENANCE

MODEL NO	WATT	DIMENSION (MM.)		
		L	W	H
F-HL-SLIM120/L	1 X T8 LED.	1245	100	100
F-HL-SLIM220/L	2 X T8 LED.	1245	150	100

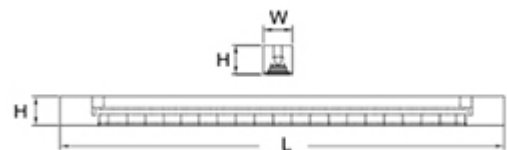

สไลด์ 1 เมตร

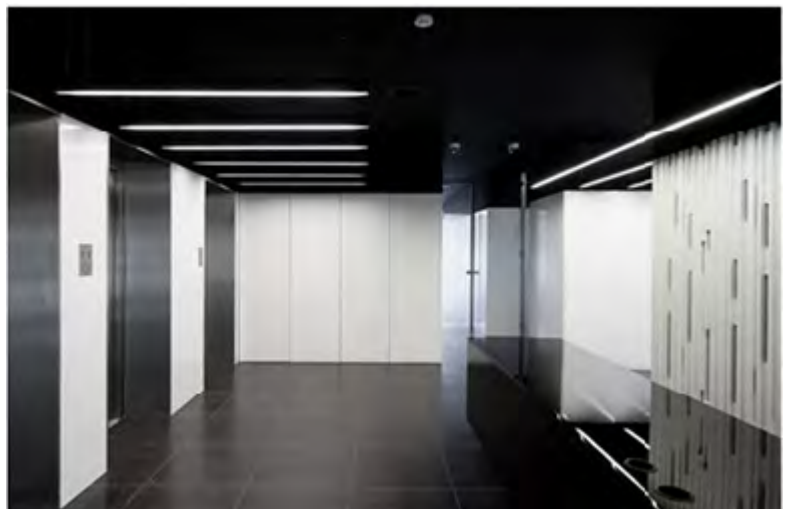

F-XL-287-5S-228P

Slim Pendant Louver Luminaire

- MADE OF ALUMINIUM
- FINISHED WITH POLYESTER POWDER BY TWO -STAGE ELECTROSTATIC METHOD.
- HEAVY DUTY ROTARY -LOCKED TYPE (TIS.344-1987 STANDARD) (GS)
- 99.85% HIGH PURITY ANODIZED ALUMINIUM REFLECTOR WITH TOTAL REFLECTANCE OF 87% (87) FOR NORMAL USAGE.
- ACRYLIC DIFFUSER
- INSTALLATION : SURFACE MOUNTING OR PENDANT

MODEL NO	WATT	DIMENSION (MM.)		
		L	W	H
F-XL-287-SS-228P	2 X T5 28W.	120	25.5	6

5,200.-

ราคาพร้อมมูลค่าดี (ไม่รวมค่าติดตั้ง)

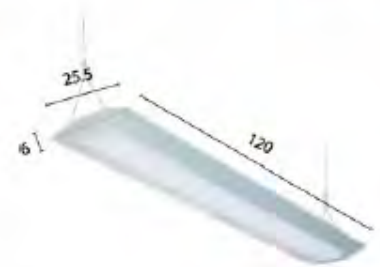

F-XL-287-5S-228V

Slim Pendant Louver Luminaire

- MADE OF ALUMINIUM
- FINISHED WITH POLYESTER POWDER BY TWO -STAGE ELECTROSTATIC METHOD.
- HEAVY DUTY ROTARY-LOCKED TYPE (TIS.344-1987 STANDARD) (GS)
- 99.85% HIGH PURITY ANODIZED ALUMINIUM REFLECTOR WITH TOTAL REFLECTANCE OF 87% (87) FOR NORMAL USAGE.
- ALUMINIUM LOUVER
- INSTALLATION : SURFACE MOUNTING OR PENDANT

MODEL NO	WATT	DIMENSION (MM.)		
		L	W	H
F-XL-287-SS-228V	2 X T5 28W.	120	25.5	6

5,600.-

ราคาพร้อมมูลค่าดี (ไม่รวมค่าติดตั้ง)

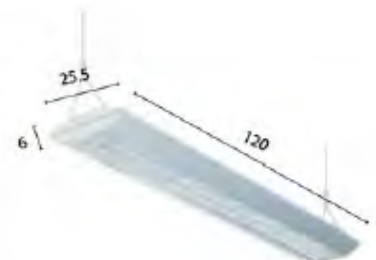



F-A

T8 Batten Type Luminaire

- HIGH QUALITY COLD- ROLLED STEEL HOUSING OF THICKNESS 0.4
- FIVE-STAGE ZINC PHOSPHATE PRETREATMENT FOR RUST RESISTANCE.
- FINISHED WITH WHITE POLYESTER POWDER BY TWO-STAGE ELECTROSTATIC METHOD.
- ROTARY-LOCKED TYPE STARTER HOLDER (TIS.344-1987 STANDARD)
- CABLE THW (TIS.11-1988 STANDARD)
- SUITABLE FOR GENERAL PURPOSE WITH HIGH EFFICIENCY REQUIREMENT



MODEL NO	WATT	DIMENSION (MM.)		
		L	W	H
F-A118/SET-1	1 X T8 18W.	636	60	97
F-A218	2 X T8 18W.	636	120	97
F-A136/SET-1	1 X T8 36W.	1245	60	97
F-A236	2 X T8 36W.	1245	120	97

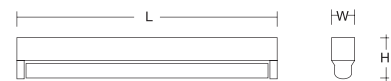

F-BT5

T5 Batten Type Luminaire

- HIGH QUALITY COLD- ROLLED STEEL HOUSING.
- FIVE-STAGE ZINC PHOSPHATE PRETREATMENT FOR RUST RESISTANCE.
- FINISHED WITH WHITE POLYESTER POWDER BY TWO-STAGE ELECTROSTATIC METHOD.
- CABLE THW (TIS.11-1988 STANDARD)
- SUITABLE FOR GENERAL PURPOSE WITH HIGH EFFICIENCY REQUIREMENT



MODEL NO	WATT	DIMENSION (MM.)		
		L	W	H
F-BT5-114	1 X T5 14W.	575	35	55
F-BT5-214	2 X T5 14W.	575	82	55
F-BT5-128	1 X T5 28W.	1175	35	55
F-BT5-228	2 X T5 28W.	1175	85	55

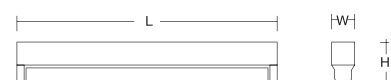

F-FW/F-FAL

T8 Industrial Type Luminaire

- HIGH QUALITY COLD-ROLLED STEEL HOUSING OF THICKNESS 0.4MM.
- FIVE-STAGE ZINC PHOSPHATE PRETREATMENT FOR RUST RESISTANCE.
- FINISHED WITH WHITE POLYESTER POWDER BY TWO-STAGE ELECTROSTATIC METHOD.
- POWDER PAINTED SHEEL SHEET REFLECTOR. OPTIONAL: 99.85% HIGH PURTIY ANODIZED ALUMINIUM REFLECTOR WITH TOTAL REFLECTANCE OF 87%(87) OR 95%(95)
- ROTARY-LOCKED TYPE STARTER HOLDER (TIS.344-1987 STANDARD)
- HEAVY DUTY LAMP HOLDER (TIS.344-1987 STANDARD)
- CABLE THW TIS.11-1988 STANDARD).
- SUITABLE FOR GENERAL PURPOSE WITH HIGH EFFICIENCY REQUIREMENT



F-FAL

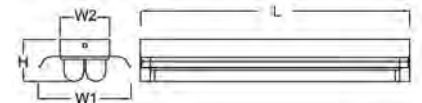

MODEL NO	WATT	DIMENSION (MM.)			
		L1	W1	W2	H
F-FW118	1 X T8 18W.	636	135	60	101
F-FAL118	1 X T8 18W.	636	135	60	101
F-FW218	2 X T8 18W.	636	230	120	101
F-FAL218	2 X T8 18W.	636	230	120	101
F-FW136	1 X T8 36W.	1245	135	60	101
F-FAL136	1 X T8 36W.	1245	135	60	101
F-FW236	2 X T8 36W.	1245	230	120	101
F-FAL236	2 X T8 36W.	1245	230	120	101

F-V

T8 Taper Batten Type Luminaire

- HIGH QUALITY COLD-ROLLED STEEL HOUSING OF THICKNESS 0.4MM.
- FIVE-STAGE ZINC PHOSPHATE PRETREATMENT FOR RUST RESISTANCE.
- FINISHED WITH WHITE POLYESTER POWDER BY TWO-STAGE ELECTROSTATIC METHOD.
- ROTARY-LOCKED TYPE STARTER HOLDER (TIS.344-1987 STANDARD)
- HEAVY DUTY LAMP HOLDER (TIS.344-1987 STANDARD)
- CABLE THW (TIS.11-1988 STANDARD).
- SUITABLE FOR GENERAL PURPOSE WITH HIGH EFFICIENCY REQUIREMENT



MODEL NO	WATT	DIMENSION (MM.)		
		L	W	H
F-V118	1 X T8 18W.	636	155	115
F-V218	2 X T8 18W.	636	155	90
F-V136	1 X T8 36W.	1245	155	115
F-V236	2 X T8 36W.	1245	155	90



F-AT5

T5 Complete Set Without Cover

- T5 ELECTRONIC FLUORESCENT BATTEN FOR HOME DECORATION
- 20% LESS ENERGY THAN AVERAGE T8 BATTEN TYPE
- HARMONIC <20%



MODEL NO	WATT	COLOR TEMPERATURE (K)	DIMENSION (MM.)		
			L	W	H
F-AT5-8	8W.	3000, 4000, 6500	315	25	37
F-AT5-14	14W.	3000, 4000, 6500	575	25	37
F-AT5-21	21W.	3000, 4000, 6500	875	25	37
F-AT5-28	28W.	3000, 4000, 6500	1175	25	37

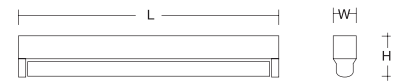

F-AT5-A3
(สายยึด Connector)



F-AT5-A1
(หัวขั้ว Terminal)

F-R

T8 Asymmetric Batten Type Luminaire

- HIGH QUALITY COLD-ROLLED STEEL HOUSING OF 0.4MM.
- FIVE-STAGE ZINC PHOSPHATE PRETREATMENT FOR RUST RESISTANCE.
- FINISHED WITH WHITE POLYESTER POWDER BY TWO-STAGE ELECTROSTATIC METHOD.
- ROTARY-LOCKED TYPE STARTER HOLDER (TIS.344-1987 STANDARD)
- HEAVY DUTY LAMP HOLDER (TIS.344-1987 STANDARD)
- CABLE THW (TIS.11-1988 STANDARD)

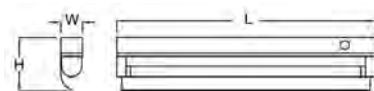

MODEL NO	WATT	DIMENSION (MM.)		
		L	W	H
F-R118	1 X T8 18W.	636	60	133
F-R136	2 X T8 36W.	1245	60	133

F-U

T8 U-Type Acrylic Diffuser Luminaire

- HIGH QUALITY COLD-ROLLED STEEL HOUSING OF THICKNESS 0.6 (T6)
- FIVE-STAGE ZINC PHOSPHATE PRETREATMENT FOR RUST RESISTANCE.
- FINISHED WITH WHITE POLYESTER POWDER BY TWO-STAGE ELECTROSTATIC METHOD.
- HIGH QUALITY ACRYLIC DIFFUSER WITH STEEL PAINTED FRAME. FOUR ACRYLIC DIFFUSERS ARE AVAILABLE: PRISMATIC (PR), OPAL (OP), STIPPLE (ST), AND CLEAR (CL)
- ROTARY-LOCKED TYPE STARTER HOLDER (TIS.344-1987 STANDARD)
- HEAVY DUTY LAMP HOLDER (TIS.344-1987 STANDARD).
- CABLE THW (TIS.11-1988 STANDARD).
- SUITABLE FOR GENERAL PURPOSE WITH HIGH EFFICIENCY REQUIREMENT



MODEL NO	WATT	DIMENSION (MM.)		
		L	W	H
F-U118	1 X T8 18W.	636	70	80
F-U218	2 X T8 18W.	636	200	80
F-U136	1 X T8 36W.	1245	70	80
F-U236	2 X T8 36W.	1245	200	80

F-UBT5

T5 U-Type Acrylic Diffuser Luminaire

- HIGH QUALITY COLD-ROLLED STEEL HOUSING
- FIVE-STAGE ZINC PHOSPHATE PRETREATMENT FOR RUST RESISTANCE.
- FINISHED WITH WHITE POLYESTER POWDER BY TWO-STAGE ELECTROSTATIC METHOD.
- HIGH QUALITY ACRYLIC DIFFUSER WITH STEEL PAINTED FRAME. FOUR ACRYLIC DIFFUSERS ARE AVAILABLE: PRISMATIC(PR), OPAL(OP), STIPPLE(ST), AND CLEAR(CL)
- HEAVY DUTY ROTARY-LOCKED TYPE(G5) LAMP HOLDER (TIS.344-1987 STANDARD).
- CABLE THW (TIS.11-1988 STANDARD).
- SUITABLE FOR GENERAL PURPOSE WITH HIGH EFFICIENCY REQUIREMENT

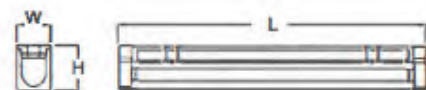

MODEL NO	WATT	DIMENSION (MM.)		
		L	W	H
F-UBT5-114	1 X T5 14W.	575	70	80
F-UBT5-214	2 X T5 14W.	575	200	80
F-UBT5-128	1 X T5 28W.	1175	70	80
F-UBT5-228	2 X T5 28W.	1175	200	80

ORDERING DATA : F-UBT5_/C C = ACRYLIC TYPE (PR=PRISMATIC, OP=OPAL ST =STIPPLE, CL=CLEAR)

F-COMPACT1

T8 U-Shape Acrylic Guard Batten Type Luminaire

- FIVE-STAGE ZINC PHOSPHATE PRETREATMENT FOR RUST RESISTANCE.
- FINISHED WITH WHITE POLYESTER POWDER BY TWO-STAGE ELECTROSTATIC METHOD.
- HIGH QUALITY ACRYLIC DIFFUSER WITH STEEL PAINTED FRAME.
- HEAVY DUTY ROTARY LOCKED TYPE LAMP HOLDER (TIS.344-1987 STANDARD)
- CABLE THW (TIS.11-1988 STANDARD).
- SUITABLE FOR GENERAL PURPOSE WITH HIGH EFFICIENCY REQUIREMENT-

MODEL NO	WATT	DIMENSION (MM.)		
		L	W	H
F-COMPACT1-118	1 X T8 LED	645	47	70
F-COMPACT1-136	1 X T8 LED	1250	47	70

โคมเปล้าสำหรับใส่หลอด LED T8



F-COMPACT

T8 U-Shape Acrylic Guard Batten Type Luminaire

- FIVE-STAGE ZINC PHOSPHATE PRETREATMENT FOR RUST RESISTANCE.
- FINISHED WITH WHITE POLYESTER POWDER BY TWO-STAGE ELECTROSTATIC METHOD.
- ROTARY-LOCKED TYPE STARTER HOLDER (TIS.344-1987 STANDARD)
- HEAVY DUTY ROTARY LOCKED TYPE LAMP HOLDER (TIS.344-1987 STANDARD).
- CABLE THW (TIS.11-1988 STANDARD).
- SUITABLE FOR GENERAL PURPOSE WITH HIGH EFFICIENCY REQUIREMENT

MODEL NO	WATT	DIMENSION (MM.)		
		L	W	H
F-COMPACT1118	1 X T8 18W.	636	70	90
F-COMPACT136	1 X T8 36W.	1240	70	90

โคมพร้อมบัลลาสต์ชนิดหลอด



F-WP

T8 Weather Proof Luminaire

- INJECTED POLYCARBONATE(PC) IN GREY COLOR WITH INJECTION MOLDED CLEAR PRISMATIC UV STABILIZED POLYCARBONATE (PC) WITH CURVED TO ANTI-GLARE.
- COLD-ROLLED STEEL PLATE, FINISHED WITH HIGH GLOSSY BAKED WHITE POLYESTER POWDER COATING
- STAINLESS CLIP LOCK (SL). OPTINAL: POLYCARBONATE (PC) CLIP LOCK
- ROTARY-LOCKED TYPE LAMP HOLDER G13 (TIS.344-1987 STANDARD)
- ROTARY-LOCKED TYPE STARTER HOLDER (TIS.344-1987 STANDARD)
- CABLE THW (TIS.11-1988 STANDARD).
- SUITABLE FOR SEMI-OUTDOOR OR OUTDOOR APPLICATION

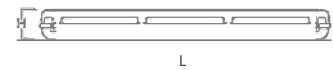

OPTIONAL: ANODIZED ALUMINIUM REFLECTOR TR 87% MIRROR FINISHED

MODEL NO	WATT	DIMENSION (MM.)		
		L	W	H
F-WP118/SET	1 X T8 18W.	670	110	108
F-WP136/SET	1 X T8 36W.	1270	110	108
F-WP236/SET	2 X T8 36W.	1270	170	108

ORDERING DATA : F-WP_/SET/A

SET = COMPLETE WITH LOW LOSS BL+ST+FLUORESCENT LAMP (DAYLIGHT)

A : REFLECTANCE ALUMINIUM REFLECTOR (87=87%)

LED-F-WP



คุณสมบัติ

- ระบายความร้อนได้ดี
- ระดับการกระเทก IK08
- ระดับกันน้ำ กันฝุ่น IP65
- ฟลักครอบพลาสติกอย่างดี ป้องกัน UV
- อายุการใช้งานยาวนานถึง 30,000 ชั่วโมง

ประโยชน์ที่ได้รับ

- อายุการใช้งานยาวนานกว่า 4 เท่าของกันน้ำ กันฝุ่นปกติ
- เนื่องจากมีระดับการกันน้ำ กันฝุ่น ถึง IP65 จึงเหมาะกับการใช้งานภายนอก
- ทนแรงกระเทกได้
- ฟลักครอบป้องกันการเปลี่ยนสี

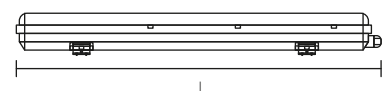

รายละเอียดสินค้า	POWER FACTOR (PF)	LUMINOUS FLUX (Lumen)	COLOR TEMP. (Kelvin)	อายุการใช้งาน (ชั่วโมง)
LED-F-WP10C/OP	0.5	900	4000K	30,000
LED-F-WP10D/OP	0.5	900	6000K	30,000
LED-F-WP20C/OP	0.5	1800	4000K	30,000
LED-F-WP20D/OP	0.5	1800	6000K	30,000

DIMENSIONAL	L	W	H
LED-F-W10_/OP	630	60	56
LED-F-W20_/OP	1230	60	56



F-WG

T8 Wire Guard Batten Type Luminaire

- HIGH QUALITY COLD-ROLLED STEEL HOUSING
- FIVE-STAGE ZINC PHOSPHATE PRETREATMENT FOR RUST RESISTANCE.
- FINISHED WITH WHITE POLYESTER POWDER BY TWO-STAGE ELECTROSTATIC METHOD.
- POWDER PAINTED STEEL WIRE GUARD
- ROTARY-LOCKED TYPE STARTER HOLDER (TIS.344-1987 STANDARD)
- HEAVY DUTY LAMP HOLDER (TIS.344-1987 STANDARD).
- CABLE THW (TIS.11-1988 STANDARD).
- SUITABLE FOR GENERAL PURPOSE WITH HIGH EFFICIENCY REQUIREMENT



MODEL NO	WATT	DIMENSION (MM.)		
		L	W	H
F-WG118	1 X T8 18W.	636	64	112
F-WG218	2 X T8 18W.	636	124	112
F-WG136	1 X T8 36W.	1245	64	112
F-WG236	2 X T8 36W.	1245	124	112

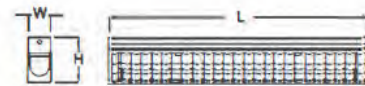

F-GAMMA

T8 Surface Batten Type Luminaire High

- HIGH QUALITY COLD-ROLLED STEEL HOUSING
- FIVE-STAGE ZINC PHOSPHATE PRETREATMENT FOR RUST RESISTANCE.
- FINISHED WITH WHITE POLYESTER POWDER BY TWO-STAGE ELECTROSTATIC METHOD.
- HEAVY DUTY ROTARY LOCKED HOLDER (TIS.344-1987 STANDARD).
- CABLE THW (TIS.11-1988 STANDARD).
- SUITABLE FOR GENERAL PURPOSE WITH HIGH EFFICIENCY REQUIREMENT
- ANODIZED ALUMINIUM REFLECTOR TF 87%



MODEL NO	WATT	DIMENSION (MM.)		
		L	W	H
F-GAMMA118	1 X T8 LED	715	115	45
F-GAMMA218	2 X T8 LED	730	161	58
F-GAMMA136	1 X T8 LED	1320	115	45
F-GAMMA236	2 X T8 LED	1338	161	58

โคมเปล่งสำหรับใช้หลอด LED T8



F-F-A

Hanging Rod

- HIGH QUALITY COLD-ROLLED STEEL HOUSING OF THICKNESS 0.6 (T6) METAL PLATE,
- STEEL ROD OF DIAMETER 1/2 INCH
- FIVE-STAGE ZINC PHOSPHATE PRETREATMENT FOR RUST RESISTANCE.
- FINISHED WITH WHITE POLYESTER POWDER BY TWO-STAGE ELECTROSTATIC METHOD.
- FOR HANGING FIXTURES

MODEL NO	DIMENSION (MM.)		
	L	W	H
F-F-A/0.5	415	330	500
F-F-A/ 1.0	415	330	1000
F-F-A/ 1.5	415	330	1500
F-F-A/ 2.0	415	330	2000
F-F-A/ 2.5	415	330	2500
F-F-A/ 3.0	415	330	3000

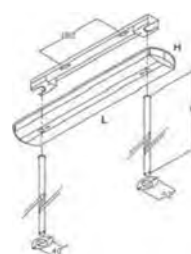

F-LR32

Recessed 32w Luminaire

HOUSING

- MADE OF HIGH QUALITY COLD-ROLLED STEEL SHEET OF THICKNESS 0.6 (T6)
- FIVE-STAGE ZINC PHOSPHATE PRETREATMENT FOR RUST RESISTANCE.
- FINISHED WITH WHITE POLYESTER POWDER BY TWO-STAGE ELECTROSTATIC METHOD.
- HEAVY DUTY ROTARY-LOCKED TYPE (TIS.344-1987 STANDARD)
- ROTARY-LOCKED TYPE STARTER HOLDER (TIS STANDARD)



MODEL NO	WATT	DIMENSION (MM.)		
		W1	W2	H
F-LR32	1 X TLE 32W	382	382	70





F-WP-E218

T8 Weather Proof Luminaire

- INJECTED POLYCARBONATE(PC) IN GREY COLOR WITH INJECTION MOLDED CLEAR PRISMATIC UV STABILIZED POLYCARBONATE (PC) WITH CURVED TO ANTI-GLARE.
- COLD-ROLLED STEEL PLATE, FINISHED WITH HIGH GLOSSY BAKED WHITE POLYESTER POWDER COATING
- STAINLESS CLIP LOCK (SL). OPTINAL: POLYCARBONATE (PC) CLIP LOCK
- ROTARY-LOCKED TYPE LAMP HOLDER G13 (TIS.344-1987 STANDARD)
- ROTARY-LOCKED TYPE STARTER HOLDER (TIS.344-1987 STANDARD)
- CABLE THW (TIS.111-1988 STANDARD).
- SUITABLE FOR SEMI-OUTDOOR OR OUTDOOR APPLICATION

OPTIONAL: ANODIZED ALUMINIUM REFLECTOR TR 87% MIRROR FINISHED

MODEL NO	WATT	DIMENSION (MM.)		
		L	W	H
F-WP-E218	2 X T8 36W.	1225	110	55

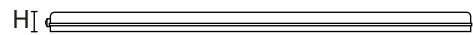

คุณสมบัติ

- ระบายความร้อนได้ดี
- ระดับการกระเทก IK08
- ระดับกันน้ำ กันฝุ่น IP65
- ฟาครอบพลาสติกอย่างดี ป้องกัน UV
- อายุการใช้งานยาวนานถึง 30,000 ชั่วโมง

ประโยชน์ที่ได้รับ

- อายุการใช้งานยาวนานกว่า 4 เท่าของกันน้ำ กันฝุ่นปกติ
- เนื่องจากมีระดับการกันน้ำ กันฝุ่น ถึง IP65 จึงเหมาะกับการใช้งานภายนอก
- ทนแรงกระเทกได้
- ฟาครอบป้องกันการเปลี่ยนสี



อายุการใช้งาน
ยาวนาน



ติดตั้งง่าย



ประหยัดพลังงาน



คุณภาพสูงอายุ
ใช้งานนาน

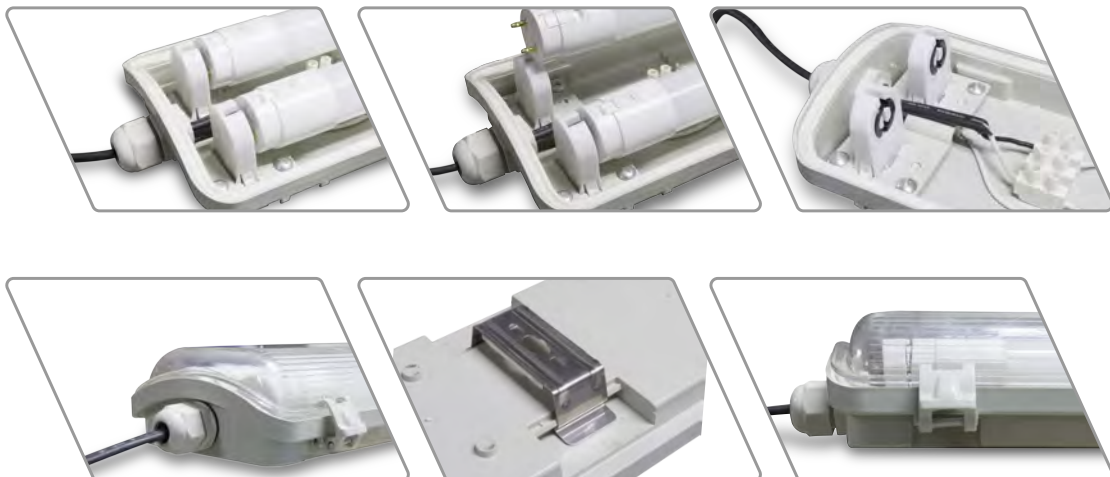



F-WP-E118

T8 Weather Proof Luminaire

- INJECTED POLYCARBONATE(PC) IN GREY COLOR WITH INJECTION MOLDED CLEAR PRISMATIC UV STABILIZED POLYCARBONATE (PC) WITH CURVED TO ANTI-GLARE.
- COLD-ROLLED STEEL PLATE, FINISHED WITH HIGH GLOSSY BAKED WHITE POLYESTER POWDER COATING
- STAINLESS CLIP LOCK (SL). OPTINAL: POLYCARBONATE (PC) CLIP LOCK
- ROTARY-LOCKED TYPE LAMP HOLDER G13 (TIS.344-1987 STANDARD)
- ROTARY-LOCKED TYPE STARTER HOLDER (TIS.344-1987 STANDARD)
- CABLE THW (TIS.11-1988 STANDARD).
- SUITABLE FOR SEMI-OUTDOOR OR OUTDOOR APPLICATION

OPTIONAL: ANODIZED ALUMINIUM REFLECTOR TR 87% MIRROR FINISHED

MODEL NO	WATT	DIMENSION (MM.)		
		L	W	H
F-WP-E118	1 X T8 36W.	1300	70	55

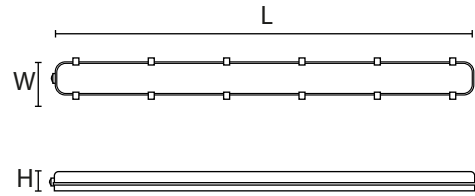

คุณสมบัติ

- ระบายความร้อนได้ดี
- ระดับการกระเทก IK08
- ระดับกันน้ำ กันฝุ่น IP65
- ฟลักซอนพลาสติกอย่างดี ป้องกัน UV
- อายุการใช้งานยาวนานถึง 30,000 ชั่วโมง

ประโยชน์ที่ได้รับ

- อายุการใช้งานยาวนานกว่า 4 เท่าของกันน้ำ กันฝุ่นปกติ
- เนื่องจากมีระดับการกันน้ำ กันฝุ่น ถึง IP65 จึงเหมาะกับการใช้งานภายนอก
- ทนแรงกระเทกได้
- ฟลักซอนป้องกันการเปลี่ยนสี



อายุการใช้งาน
ยาวนาน



ติดตั้งง่าย



ประหยัดพลังงาน



คุณภาพสูง
ติดตั้งดี





F-WP-E109

T8 Weather Proof Luminaire

- INJECTED POLYCARBONATE(PC) IN GREY COLOR WITH INJECTION MOLDED CLEAR PRISMATIC UV STABILIZED POLYCARBONATE (PC) WITH CURVED TO ANTI-GLARE.
- COLD-ROLLED STEEL PLATE, FINISHED WITH HIGH GLOSSY BAKED WHITE POLYESTER POWDER COATING
- STAINLESS CLIP LOCK (SL). OPTINAL: POLYCARBONATE (PC) CLIP LOCK
- ROTARY-LOCKED TYPE LAMP HOLDER G13 (TIS.344-1987 STANDARD)
- ROTARY-LOCKED TYPE STARTER HOLDER (TIS.344-1987 STANDARD)
- CABLE THW (TIS.111-1988 STANDARD).
- SUITABLE FOR SEMI-OUTDOOR OR OUTDOOR APPLICATION

OPTIONAL: ANODIZED ALUMINIUM REFLECTOR TR 87% MIRROR FINISHED

MODEL NO	WATT	DIMENSION (MM.)		
		L	W	H
F-WP-E109	1 X T8 9W.	690	70	55

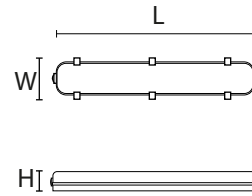

คุณสมบัติ

- ระบายความร้อนได้ดี
- ระดับการกระเทก IK08
- ระดับกันน้ำ กันฝุ่น IP65
- ฟลักครอบพลาสติกอย่างดี ป้องกัน UV
- อายุการใช้งานยาวนานถึง 30,000 ชั่วโมง

ประโยชน์ที่ได้รับ

- อายุการใช้งานยาวนานกว่า 4 เท่าของกันน้ำ กันฝุ่นปกติ
- เนื่องจากมีระดับการกันน้ำ กันฝุ่น ถึง IP65 จึงเหมาะกับการใช้งานภายนอก
- ทนแรงกระเทกได้
- ฟลักครอบป้องกันการเปลี่ยนสี



อายุการใช้งาน
ยาวนาน



ติดตั้งง่าย



ประหยัดพลังงาน



คุณภาพสูงอายุ
ใช้งานนาน





F-WG136/S

T8 Batten Type Luminaire

- HIGH QUALITY COLD- ROLLED STEEL HOUSING OF THICKNESS 0.6
- FIVE-STAGE ZINC PHOSPHATE PRETREATMENT FOR RUST RESISTANCE.
- FINISHED WITH WHITE POLYESTER POWDER BY TWO-STAGE ELECTROSTATIC METHOD.
- ROTARY-LOCKED TYPE STARTER HOLDER (TIS.344-1987 STANDARD)
- CABLE THW (TIS.11-1988 STANDARD)
- SUITABLE FOR GENERAL PURPOSE WITH HIGH EFFICIENCY REQUIREMENT

MODEL NO	WATT	DIMENSION (MM.)		
		L	W	H
F-WG136	1 X T8 36W	1250	60	100



F-WGS136

T8 Batten Type Luminaire

- HIGH QUALITY COLD- ROLLED STEEL HOUSING OF THICKNESS 0.6
- FIVE-STAGE ZINC PHOSPHATE PRETREATMENT FOR RUST RESISTANCE.
- FINISHED WITH WHITE POLYESTER POWDER BY TWO-STAGE ELECTROSTATIC METHOD.
- ROTARY-LOCKED TYPE STARTER HOLDER (TIS.344-1987 STANDARD)
- CABLE THW (TIS.11-1988 STANDARD)
- SUITABLE FOR GENERAL PURPOSE WITH HIGH EFFICIENCY REQUIREMENT

MODEL NO	WATT	DIMENSION (MM.)		
		L	W	H
F-WGS136	1 X T8 36W	1230	58	98



acariñ 3 MM.

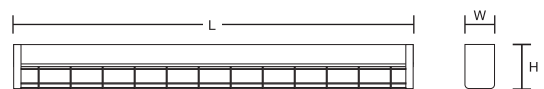

LED PANEL SLIM ROUND

ALUMINIUM BODY, WORKING VOLTAGE AC 85-265V, CHIP TYPE EPISTAR
 LUMEN PER WATT 85-90 LM/WATT, BEAM ANGLE 120 DEG
 LIFE TIME 25,000 Hrs.

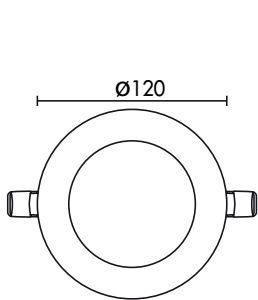

LED-PN006D/LTO
LED-PN006W/LTO
 EPISTAR 2835 SMD LED CHIP
 540 LM
 220V,AC, 50/60HZ
 160.-

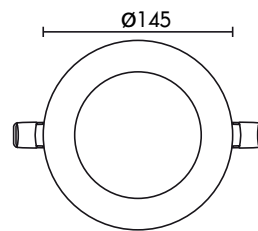

LED-PN009D/LTO
LED-PN009W/LTO
 EPISTAR 2835 SMD LED CHIP
 810 LM
 220V,AC, 50/60HZ
 220.-

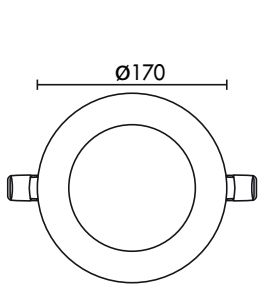

LED-PN012D/LTO
LED-PN012W/LTO
 EPISTAR 2835 SMD LED CHIP
 1080 LM
 220V,AC, 50/60HZ
 280.-

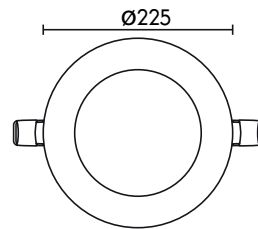

LED-PN018D/LTO
LED-PN018W/LTO
 EPISTAR 2835 SMD LED CHIP
 1620 LM
 220V,AC, 50/60HZ
 340.-



DAYLIGHT
(6000K)



WARMWHITE
(3000K)



LED PANEL SLIM SQUARE

ALUMINIUM BODY, WORKING VOLTAGE AC 85-265V, CHIP TYPE EPISTAR
 LUMEN PER WATT 85-90 LM/WATT, BEAM ANGLE 120 DEG
 LIFE TIME 25,000 Hrs.

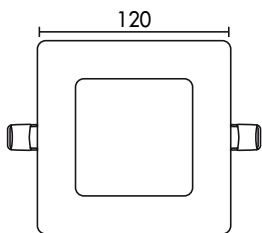
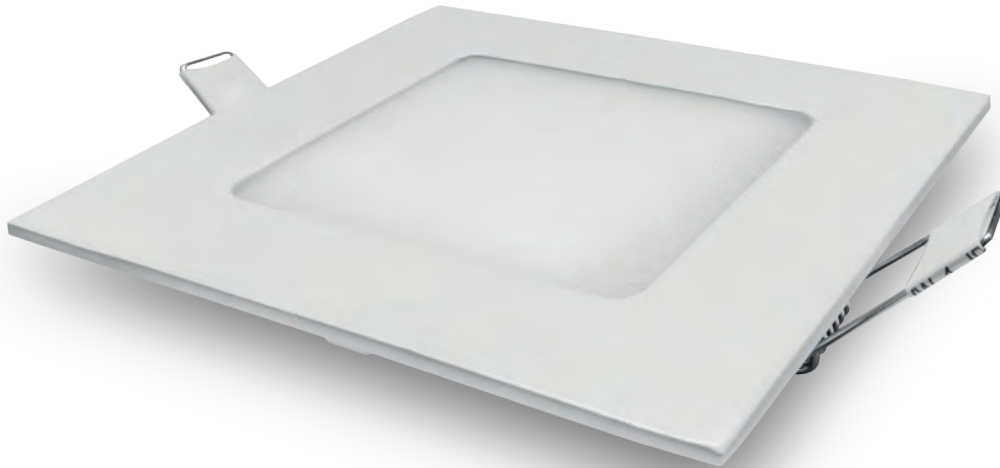

LED-PN406D/LTO
LED-PN406W/LTO

EPISTAR 2835 SMD LED CHIP
 540 LM
 220V,AC, 50/60HZ
 160.-

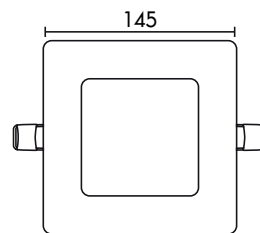

LED-PN409D/LTO
LED-PN409W/LTO

EPISTAR 2835 SMD LED CHIP
 810 LM
 220V,AC, 50/60HZ
 220.-

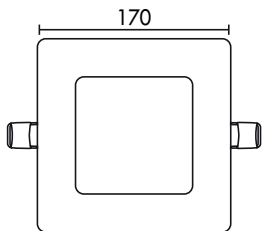

LED-PN412D/LTO
LED-PN412W/LTO

EPISTAR 2835 SMD LED CHIP
 1080 LM
 220V,AC, 50/60HZ
 280.-

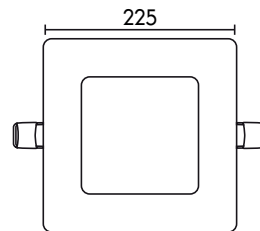

LED-PN418D/LTO
LED-PN418W/LTO

EPISTAR 2835 SMD LED CHIP
 1620 LM
 220V,AC, 50/60HZ
 340.-



DAYLIGHT
(6000K)



WARMWHITE
(3000K)



LED PANEL SLIM SQUARE

ALUMINIUM BODY, WORKING VOLTAGE AC 85-265V, CHIP TYPE EPISTAR
LUMEN PER WATT 90-100 LM/WATT, BEAM ANGLE 120 DEG
LIFE TIME 25,000 Hrs.



LED-PNS406D/LTO LED-PNS406W/LTO

EPISTAR 2835 SMD LED CHIP
540 LM
220V,AC, 50/60HZ
270.-

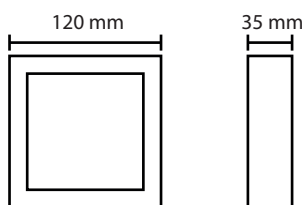

LED-PNS412D/LTO LED-PNS412W/LTO

EPISTAR 2835 SMD LED CHIP
1080 LM
220V,AC, 50/60HZ
400.-

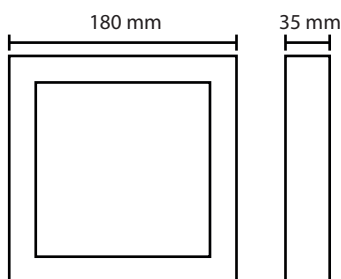

LED-PNS418D/LTO LED-PNS418W/LTO

EPISTAR 2835 SMD LED CHIP
1620 LM
220V,AC, 50/60HZ
490.-

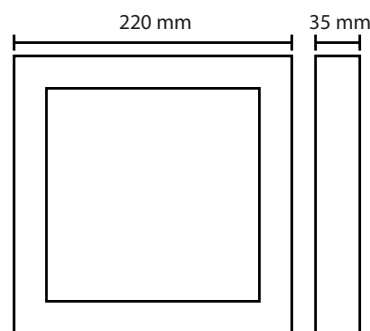

DAYLIGHT
(6000K)



WARMWHITE
(3000K)



พจน. 1955-2551

LED PANEL SLIM ROUND

ALUMINIUM BODY, WORKING VOLTAGE AC 85-265V, CHIP TYPE EPISTAR
 LUMEN PER WATT 90-100 LM/WATT, BEAM ANGLE 120 DEG
 LIFE TIME 25,000 Hrs,



LED-PNS06D/LTO LED-PNS06W/LTO

EPISTAR 2835 SMD LED CHIP
 540 LM
 220V,AC, 50/60HZ
 270.-

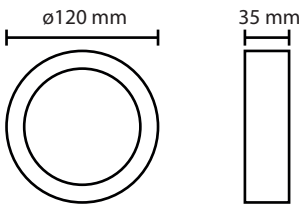

LED-PNS012D/LTO LED-PNS012W/LTO

EPISTAR 2835 SMD LED CHIP
 1080 LM
 220V,AC, 50/60HZ
 400.-

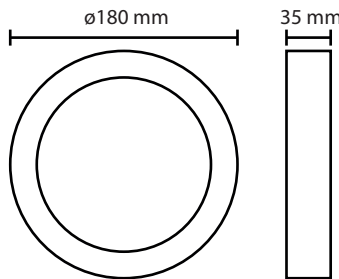

LED-PNS018D/LTO LED-PNS018W/LTO

EPISTAR 2835 SMD LED CHIP
 1620 LM
 220V,AC, 50/60HZ
 490.-

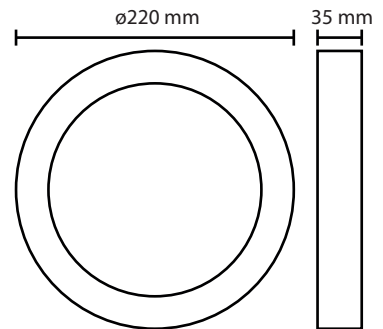

DAYLIGHT
(6000K)



WARMWHITE
(3000K)



พณ. 1955-2551



LED-LA60 LED-LA70

LED GLS Retrofit Lamp

คุณสมบัติ

- เปลี่ยนสีได้ 3 สี ได้แก่ 3000K(วอร์มไวท์), 4000K(คลูไวท์), 6000K(เดย์ไลท์) (เฉพาะ: LED-LA607DWC/OP และ LED-LA609DWC/OP)
- อายุการใช้งานยาวนาน 25,000 ชม.
- ประหยัดพลังงาน

ประโยชน์ที่ได้รับ

- เปลี่ยนสีได้เพียงแค่ออกสวิตช์ เปิด/ปิด (เฉพาะ: LED-LA607DWC/OP และ LED-LA609DWC/OP)
- อายุการใช้งานยาวนานเป็น 20 เท่า เมื่อเทียบกับหลอดไส้ทั่วไป ประหยัดไฟสูงสุดถึง 85% เมื่อเทียบกับหลอดไส้ทั่วไป และ ประหยัดไฟสูงสุดถึง 40% เมื่อเทียบกับหลอดตะเกียบทั่วไป

A60 E27

ø60 mm

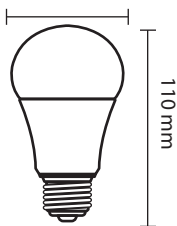

A70 E27

ø70 mm

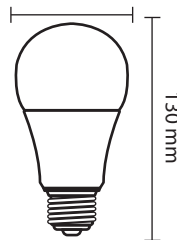

รายละเอียดสินค้า	WATT (W)	POWER FACTOR (PF)	LUMINOUS FLUX (Lumen)	COLOR TEMP. (Kelvin)
LED-LA607DWC/OP	7	>0.5	650	COLOR 3 IN 1
LED-LA609DWC/OP	9	>0.5	806	COLOR 3 IN 1

รายละเอียดสินค้า	WATT (W)	POWER FACTOR (PF)	LUMINOUS FLUX (Lumen)	COLOR TEMP. (Kelvin)
LED-LA607W/OP	7	>0.5	500	3000K
LED-LA607C/OP	7	>0.5	550	4000K
LED-LA607D/OP	7	>0.5	550	6000K
LED-LA609W/OP	9	>0.5	850	3000K
LED-LA609C/OP	9	>0.5	850	4000K
LED-LA609D/OP	9	>0.5	850	6000K
LED-LA7012W/OP	12	>0.5	1000	3000K
LED-LA7012C/OP	12	>0.5	1100	4000K
LED-LA7012D/OP	12	>0.5	1100	6000K
LED-LA7014W/OP	14	>0.5	1350	3000K
LED-LA7014C/OP	14	>0.5	1350	4000K
LED-LA7014D/OP	14	>0.5	1350	6000K

รายละเอียดสินค้า	WATT (W)	POWER FACTOR (PF)	LUMINOUS FLUX (Lumen)	COLOR TEMP. (Kelvin)
LED-LA609W-DIM/OP	9	>0.9	806	2700K



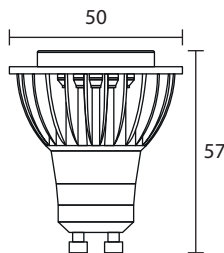

LED-LGU106/OP

คุณสมบัติ

- ใช้ได้ตั้งแต่ 100-240V
- เลนส์กระจายแสงได้รับการออกแบบมาเป็นพิเศษ
- มีให้เลือกหลายขนาดวัตต์และหลายมุมกระจายแสง
- ประหยัดพลังงาน

ประโยชน์ที่ได้รับ

- เนื่องจากใช้ได้ตั้งแต่ 100-240V ทำให้ใช้งานได้แม้ไฟตก
- ไร้แสงฟุ้งเป็นล้า เนื่องจากเลนส์ถูกออกแบบมาเป็นพิเศษ
- ติดตั้งง่าย เพราะไม่ต้องใช้หม้อแปลง
- ประหยัดไฟสูงสุด 85% เมื่อเทียบกับหลอดฮาโลเจน GU10 ทั่วไป

รายละเอียดสินค้า	POWER FACTOR (PF)	LUMINOUS FLUX (Lumen)	COLOR TEMP. (Kelvin)	อายุการใช้งาน (ชั่วโมง)
LED-LGU106W-24/OP	>0.5	450	3,000	25,000
LED-LGU106D-24/OP	>0.5	450	5,700	25,000
LED-LGU106W-36/OP	>0.5	450	3,000	25,000
LED-LGU106D-36/OP	>0.5	450	5,700	25,000

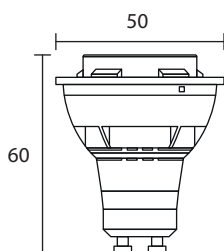

LED-LGU107/DIM/OP

คุณสมบัติ

- สามารถปรับความสว่างได้ตั้งแต่ 10-100%
- ใช้เทคโนโลยี COB แบบ SINGLE LENS
- ออกแบบมาให้เหมาะสมกับที่อยู่อาศัย
- ประหยัดพลังงาน

ประโยชน์ที่ได้รับ

- ปรับความเข้มแสงได้ตามต้องการ
- ให้ความรู้สึกเหมือนหลอดฮาโลเจน
- กระจายความร้อนได้ดี ช่วยลดอุณหภูมิภายในหลอดไฟ ทำให้ยืดอายุการใช้งานยาวนานเป็นพิเศษ
- ประหยัดไฟสูงสุด 85% เมื่อเทียบกับหลอดฮาโลเจน GU10 ทั่วไป

รายละเอียดสินค้า	POWER FACTOR (PF)	LUMINOUS FLUX (Lumen)	COLOR TEMP. (Kelvin)	อายุการใช้งาน (ชั่วโมง)
LED-LGU107W/DIM-24/OP	>0.5	450	2,700	25,000
LED-LGU107W/DIM-36/OP	>0.5	450	2,700	25,000
LED-LGU107D/DIM-24/OP	>0.5	450	5,700	25,000
LED-LGU107D/DIM-36/OP	>0.5	450	5,700	25,000

LED-LHA2205.5W/LTO

LED MR16 Retrofit Lamp



LED-LGU106W/LTO

LED GU10 Retrofit Lamp



รายละเอียดสินค้า

	ชื่อ	WATT (W)	VOLTAGE	LUMINOUS FLUX (Lumen)	COLOR TEMP (Kelvin)	อายุการใช้งาน (ชั่วโมง)
LED-LGU106W/LTO	GU10	6	220V	450	3000K	15,000
LED-LHA2205.5W/LTO	MR16	5.5	220V	450	3000K	15,000

LED-LHA125_/OP

LED MR16 Retrofit Lamp



รายละเอียดสินค้า

	ชื่อ	WATT (W)	VOLTAGE	LUMINOUS FLUX (Lumen)	COLOR TEMP (Kelvin)	อายุการใช้งาน (ชั่วโมง)
LED-LHA125W/OP	MR16	5	12V	340	2700K	30,000
LED-LHA125C/OP	MR16	5	12V	380	4000K	30,000
LED-LHA125D/OP	MR16	5	12V	400	5700K	30,000



คุณสมบัติ

- เลนส์กระจายแสงได้รับการออกแบบมาเป็นพิเศษ
- อายุการใช้งานยาวนาน
- ประหยัดพลังงาน

ประโยชน์ที่ได้รับ

- ให้แสงสวยงามคมชัด สามารถใช้ร่วมกับโคมไฟหลากหลายรูปแบบ
- อายุการใช้งานยาวนานกว่าหลอดฮาโลเจนทั่วไปถึง 20 เท่า
- ประหยัดไฟสูงสุด 85% เมื่อเทียบกับหลอดฮาโลเจนทั่วไป



LED-HB-E100/OP

Lowbay EcoMax

รายละเอียดสินค้า	POWER FACTOR (PF)	LUMINOUS FLUX (Lumen)	COLOR TEMP (Kelvin)	อายุการใช้งาน (ชั่วโมง)
LED-HB-E100D-60/OP	>0.95	900	5,700	30,000
LED-HB-E100D-90/OP	>0.95	10500	5,700	30,000



LED-HB-E150/OP

Lowbay EcoMax

รายละเอียดสินค้า	POWER FACTOR (PF)	LUMINOUS FLUX (Lumen)	COLOR TEMP (Kelvin)	อายุการใช้งาน (ชั่วโมง)
LED-HB-E150D-60/OP	>0.95	13500	5,700	30,000
LED-HB-E150D-90/OP	>0.95	15750	5,700	30,000

คุณสมบัติ

- ระบายความร้อนได้ดี
- อายุการใช้งานยืนยาวนาน
- ประสิทธิภาพส่องสว่างสูงถึง 105 LM/W
- มีองศาการกระจายแสงให้เลือก 2 องศา
- ติดตั้งได้ทั้งแบบ ตะขอกะเกี่ยว, ก้านแขิง, ติดผนัง

ประโยชน์ที่ได้รับ

- อายุการใช้งานนานกว่าโคมโลว์เบย์แบบเดิมถึง 4 เท่า
- สามารถติดตั้งแทนโคมโลว์เบย์แบบเดิมได้ทันที
- ประหยัดไฟสูงสุดถึง 50% เมื่อเทียบโคมโลว์เบย์แบบเดิม
- ใช้งานได้หลายรูปแบบ หลายสภาพแวดล้อม
- ติดตั้งง่าย

DIMENSIONAL	H	Ø
LED-HB-E100D-60/OP	415mm.	330mm.
LED-HB-E100D-90/OP	335mm.	412mm.
LED-HB-E150D-60/OP	475mm.	330mm.
LED-HB-E150D-90/OP	395mm.	412mm.

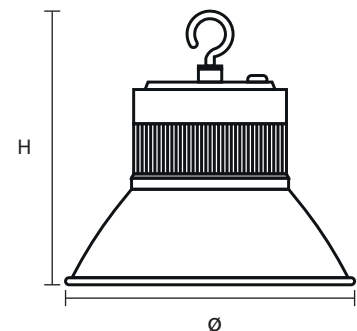
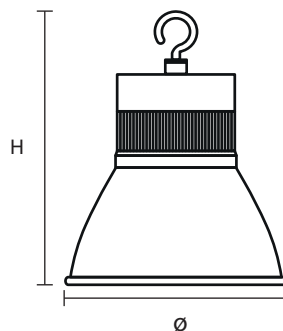

LED-L22-16_/OP

ECOMAX CEILING MODULE (C MODULE)



รายละเอียดสินค้า	POWER FACTOR (PF)	LUMINOUS FLUX (Lumen)	COLOR TEMP. (Kelvin)	อายุการใช้งาน (ชั่วโมง)
LED-L22-16W/OP	0.5	1450	3000k	15,000
LED-L22-16D/OP	0.5	1750	5700k	15,000

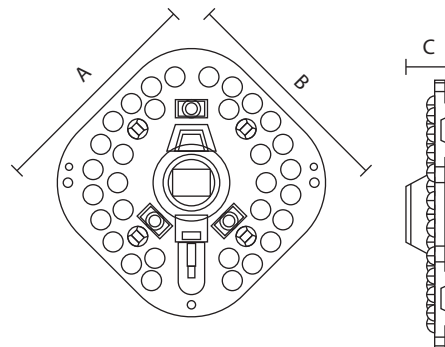

DIMENSIONAL

A (mm)	162
B (mm)	162
C (mm)	30

LED-L32-24CW/OP

ECOMAX CEILING MODULE (C MODULE)



รายละเอียดสินค้า	POWER FACTOR (PF)	LUMINOUS FLUX (Lumen)	COLOR TEMP. (Kelvin)	อายุการใช้งาน (ชั่วโมง)
LED-L32-24CW/OP	0.5	1800	4500K/3000k (สลับสี)	25,000

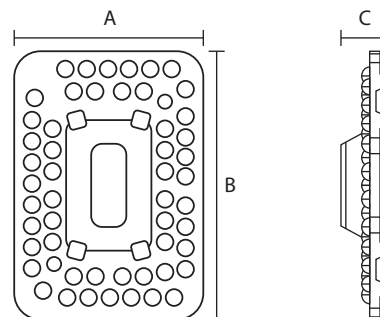

DIMENSIONAL

A (mm)	157
B (mm)	162
C (mm)	30

คุณสมบัติ

- ใช้แม่เหล็กสำหรับยึดติดใต้อุปกรณ์ฝ้าสูง
- เลนส์กระจายแสงได้เป็นการออกแบบมาเป็นพิเศษ
- เปิดติดกันที่ไม่มีกระพริบ
- ประหยัดพลังงาน

ประโยชน์ที่ได้รับ

- ใช้ทดแทนหลอดฟลูออเรสเซนต์
- กระจายแสงทั่วถึง ปราศจากจุดมืด
- เปิดติดได้เมื่ออยู่ในพื้นที่ที่มีอุณหภูมิต่ำ
- ประหยัดไฟสูงสุดถึง 60%เมื่อเทียบกับหลอดฟลูออเรสเซนต์แบบเดิม

โคมเพดานอะคริลิกคุณภาพสูง
 มาพร้อม LED 22W
 สามารถรับได้ 2 สี โดยใช้สวิตช์ (ปิด-เปิด)



C-HC48-22WC/OP

D Dimensions

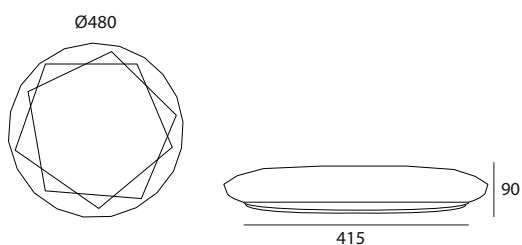

สินค้ารับประกัน 2 ปี

STEP-1
DAYLIGHT(22W)
(4000K)

STEP-2
WARMWHITE(5W)
(3000K)

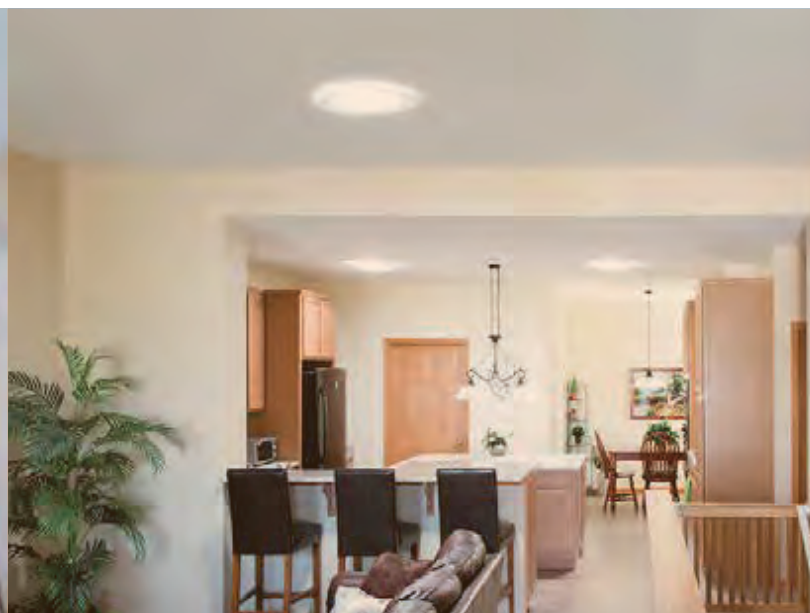
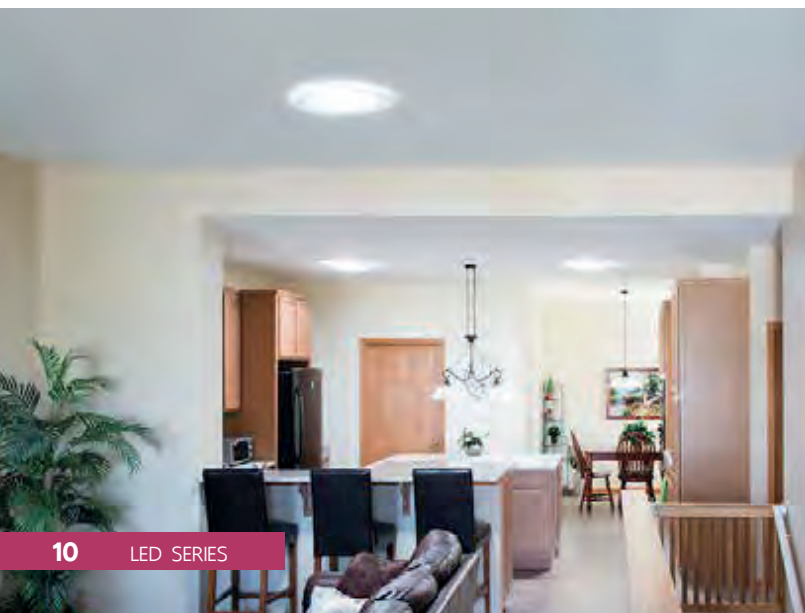

โคมเพดานอะคริลิกคุณภาพสูง
มาพร้อม LED 16W (สามารถเปลี่ยนหลอดได้ในอนาคต)
มีให้เลือกทั้งแสง Daylight(6000K) และ Warmwhite(3000K)



C-HC35-16D/OP
C-HC35-16W/OP

D Dimensions

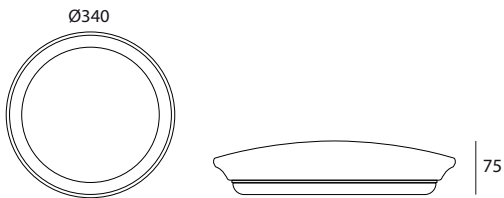

สินค้ารับประกัน 2 ปี



พอก. 1955-2551



DAYLIGHT
(6000K)

WARMWHITE
(3000K)

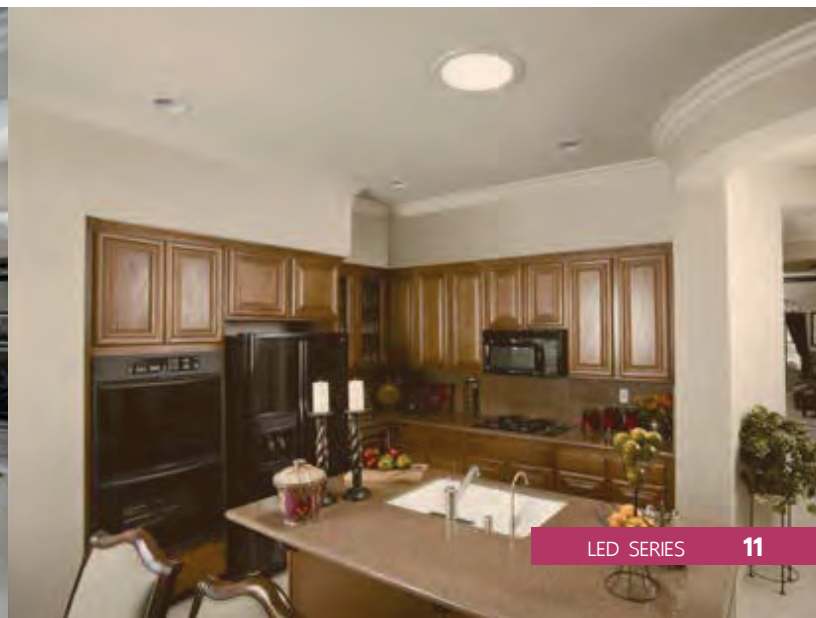



C-ME00/32

HOUSING : ACRYLIC COVER.
STEEL PLATE

E27X2
360.-
LED-16W
580.-

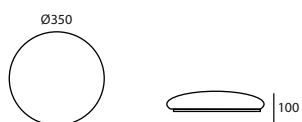

C-ME00/22

HOUSING : ACRYLIC COVER.
STEEL PLATE

E27X1 (GENIE 18W)
300.-

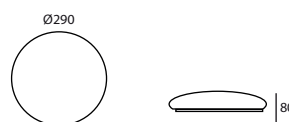

C-ME01/32

HOUSING : ACRYLIC COVER.
STEEL PLATE

E27X2
360.-
LED-16W
580.-

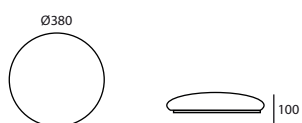

C-ME01/22

HOUSING : ACRYLIC COVER.
STEEL PLATE

E27X1 (GENIE 18W)
300.-

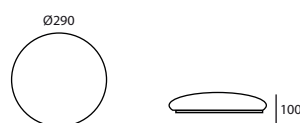

C-ME05/32

HOUSING : ACRYLIC COVER.
STEEL PLATE

E27X2
360.-
LED-16W
580.-

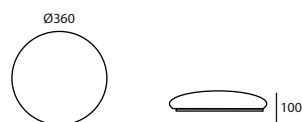

C-ME05/22

HOUSING : ACRYLIC COVER.
STEEL PLATE

E27X1 (GENIE 18W)
300.-

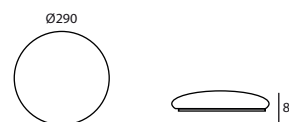



C-A200

HOUSING : ACRYLIC COVER.
STEEL PLATE

E27X2
420.-
LED-16W
700.-

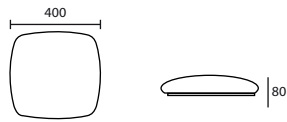

C-A300

HOUSING : ACRYLIC COVER.
STEEL PLATE

E27X2
420.-
LED-16W
700.-

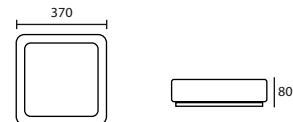

C-A400

HOUSING : ACRYLIC COVER.
STEEL PLATE

E27X2
420.-
LED-16W
700.-

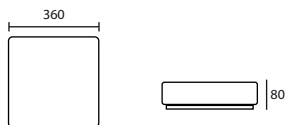

C-ME09

HOUSING : ACRYLIC COVER.
STEEL PLATE

E27X2
360.-
LED-16W
640.-

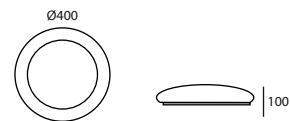

C-ME09AL/D330

HOUSING : ACRYLIC COVER. ALUMINIUM TRIM,
STEEL PLATE

E27X1 (GENIE 18W)
700.-
LED-16W
980.-

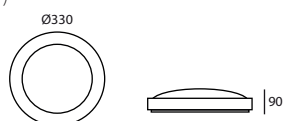



LED-RB/2835/_/OP

Led Ribbon Strip Light

รายละเอียดสินค้า	WATT (W)	LUMINOUS FLUX (Lumen)	COLOR TEMP. (Kelvin)	VOLT (V)	อายุการใช้งาน (ชั่วโมง)
LED-RB/2835/27/OP	6W/M	620	2700K	12V DC	15,000
LED-RB/2835/30/OP	6W/M	650	3000K	12V DC	15,000
LED-RB/2835/40/OP	6W/M	680	4000K	12V DC	15,000
LED-RB/2835/65/OP	6W/M	690	6500K	12V DC	15,000

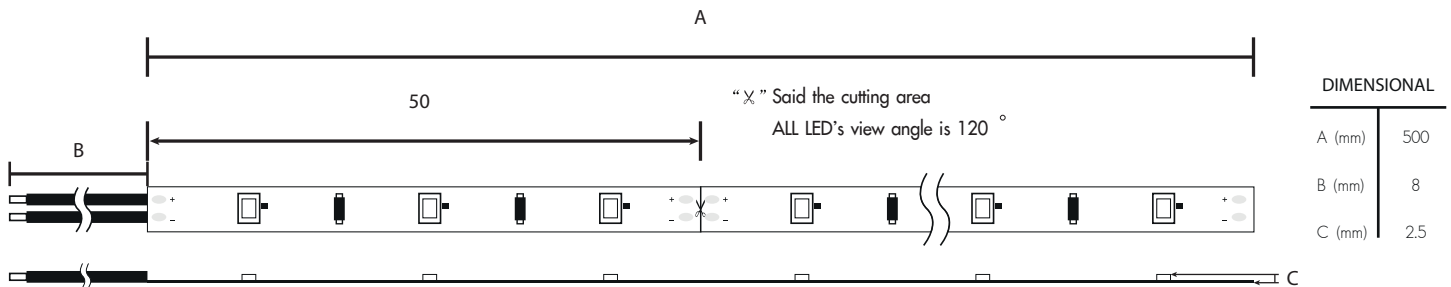

LED-TRRS1235/MW LED-TRRS1275/MW LED-TRNES12150/MW

Enclosed Switching Power Supply



AC INPUT VOLTAGE RANGE	88-264/125-373VDC
DC ADJUSTMENT RANGE	±10% RATED OUTPUT RANGE
OVERLOAD PROTECTION	110-150% RATED OUTPUT POWER
OVER VOLTAGE PROTECTION	115%-145% RATED OUTPUT VOLTAGE
WORKING TEMPERATURE	-20°C +50°C (REFER TO OUTPUT DERATING CURVE)
SAFETY STANDARDS	UL60950-1 APPROVED

LED-TRNES12200/MW

Enclosed Switching Power Supply

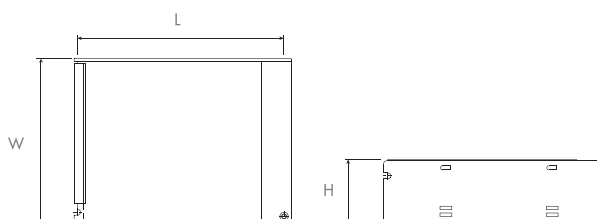

LED-TRNES12350/MW

Enclosed Switching Power Supply



รายละเอียดสินค้า	OUTPUT	DIMENSION (W x L x H)	WATT (W)
LED-TRRS1250/MW	12V 0-3A	98X98X38	50W
LED-TRRS1275/MW	12V 0-6A	129X98X38	75W
LED-TRNES12150/MW	12V 0-12.5A	197X98X38	150W
LED-TRNES12200/MW	12V 0-17A	215X115X50	210W
LED-TRNES12350/MW	12V 0-29A	215X115X50	350W

LED-FAT5/OP

ECOMAX T5 BATTEN (PUMX)



LED-FAT5-A1/OP
(1 หัว ใช้จ่ายไฟ)



LED-FAT5-A3/OP
(2 หัว ใช้เข้ามุม)

คุณสมบัติ

- โครงสร้างแบบ UNIBODY ไร้รอยต่อพร้อมตัวต่อระหว่างรางในตัว
- มีหลากหลายขนาดให้เลือกใช้
- ประหยัดพลังงาน

รายละเอียดสินค้า	WATT (W)	POWER FACTOR (PF)	LUMINOUS FLUX (Lumen)	COLOR TEMP. (Kelvin)
LED-FAT5-3.5W/OP	3.5	0.5	240	3000K
LED-FAT5-3.5C/OP	3.5	0.5	260	4000K
LED-FAT5-3.5D/OP	3.5	0.5	300	5700K
LED-FAT5-7W/OP	7	0.5	480	3000K
LED-FAT5-7C/OP	7	0.5	520	4000K
LED-FAT5-7D/OP	7	0.5	600	5700K
LED-FAT5-10W/OP	10.5	0.5	710	3000K
LED-FAT5-10C/OP	10.5	0.5	770	4000K
LED-FAT5-10D/OP	10.5	0.5	900	5700K
LED-FAT5-14W/OP	14	0.5	950	3000K
LED-FAT5-14C/OP	14	0.5	1030	4000K
LED-FAT5-14D/OP	14	0.5	1200	5700K

ประโยชน์ที่ได้รับ

- ติดตั้งง่าย
- จุดเชื่อมต่อระหว่างรางไม่มีจุดมืด
- ประหยัดไฟสูงสุดถึง 50% เมื่อเทียบกับหลอดฟลูออเรสเซนต์ T5 ทัวไป
- มีอายุการใช้งาน 20,000 ชม

LED-FAT5-UT/OP

UTILITY T5 BATTEN (UMX)



LED-FAT5-UT-A1/OP
(1 หัว ใช้จ่ายไฟ)



LED-FAT5-UT-A2/OP
(ตัวต่อระหว่างราง)



LED-FAT5-UT-A3/OP
(2 หัว ใช้เข้ามุม)

คุณสมบัติ

- โครงสร้างผลิตจากอลูมิเนียมเนื้อดี
- มีหลากหลายขนาดให้เลือกใช้
- ประหยัดพลังงาน

รายละเอียดสินค้า	POWER FACTOR (PF)	POWER FACTOR (PF)	LUMINOUS FLUX (Lumen)	COLOR TEMP. (Kelvin)
LED-FAT5-UT-3.5W/OP	3.5	0.5	270	3000K
LED-FAT5-UT-3.5C/OP	3.5	0.5	270	4000K
LED-FAT5-UT-3.5D/OP	3.5	0.5	270	5700K
LED-FAT5-UT-7W/OP	7	0.5	530	3000K
LED-FAT5-UT-7C/OP	7	0.5	530	4000K
LED-FAT5-UT-7D/OP	7	0.5	530	5700K
LED-FAT5-UT-14W/OP	14	0.5	1050	3000K
LED-FAT5-UT-14C/OP	14	0.5	1050	4000K
LED-FAT5-UT-14D/OP	14	0.5	1050	5700K

ประโยชน์ที่ได้รับ

- ติดตั้งง่าย
- จุดเชื่อมต่อระหว่างรางไม่มีจุดมืด
- ประหยัดไฟสูงสุดถึง 50% เมื่อเทียบกับหลอดฟลูออเรสเซนต์ T5 ทัวไป
- มีอายุการใช้งาน 20,000 ชม

LED-LT8-ECO/OP

UTILITY T5 BATTEN (UMX)



รายละเอียดสินค้า	POWER FACTOR (PF)	LUMINOUS FLUX (Lumen)	COLOR TEMP. (Kelvin)	อายุการใช้งาน (ชั่วโมง)
LED-LT8-ECO9W/OP	>0.5	750	3000K	15,000
LED-LT8-ECO9C/OP	>0.5	800	4000K	15,000
LED-LT8-ECO9D/OP	>0.5	800	6500K	15,000
LED-LT8-ECO18W/OP	>0.5	1500	3000K	15,000
LED-LT8-ECO18C/OP	>0.5	1600	4000K	15,000
LED-LT8-ECO18D/OP	>0.5	1600	6500K	15,000

LED-LT8-UT/OP

UTILITY T5 BATTEN (UMX)



รายละเอียดสินค้า	POWER FACTOR (PF)	LUMINOUS FLUX (Lumen)	COLOR TEMP. (Kelvin)	อายุการใช้งาน (ชั่วโมง)
LED-LT8-UT9W/OP	>0.5	750	3000K	20,000
LED-LT8-UT9C/OP	>0.5	800	4000K	20,000
LED-LT8-UT9D/OP	>0.5	800	6500K	20,000
LED-LT8-UT18W/OP	>0.5	1500	3000K	20,000
LED-LT8-UT18C/OP	>0.5	1600	4000K	20,000
LED-LT8-UT18D/OP	>0.5	1600	6500K	20,000

คุณสมบัติ

- ปราศจากการกระพริบ (FLICKER FREE)
- ควรใช้คู่กับ LED STARTER ของ OPPLE
- อายุการใช้งานยืนยาวนาน
- ประหยัดพลังงาน
- เทคโนโลยีเคสึอนหลอดแบบพิเศษ (LED-LT8-UT/OP)

ประโยชน์ที่ได้รับ

- ให้แสงนุ่มนวล สบายตา
- ทนอมสายตา
- ความร้อนต่ำ
- อายุการใช้งานยาวนานถึง 15,000 ชั่วโมง (LED-LT8-ECO/OP) และ อายุการใช้งานยาวนานถึง 20,000 ชั่วโมง (LED-LT8-UT/OP)
- ประหยัดไฟสูงสุดถึง 60% เมื่อเทียบกับหลอดฟลูออโรสเซนต์ T8 ทั่วไป



LED-STARTER
(REPLACEMENT FOR CONVENTIONAL T8 BATTEN STARTER)

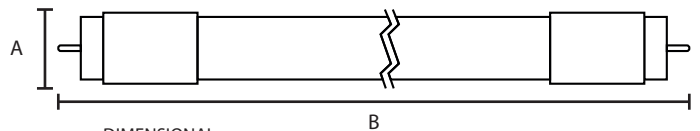

DIMENSIONAL	9W	18W
	A (MM)	Ø28
B (MM)	604	1213

ระบบวงจร TUBE มี 3 แบบ

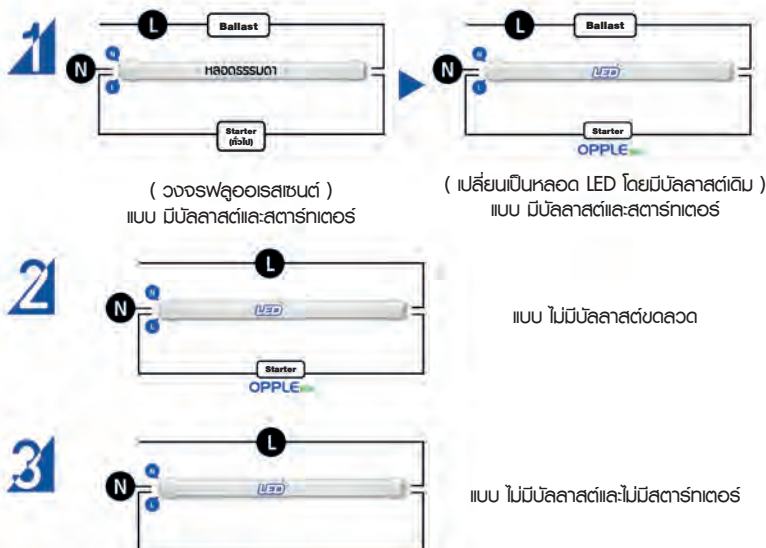

LED-DOP_

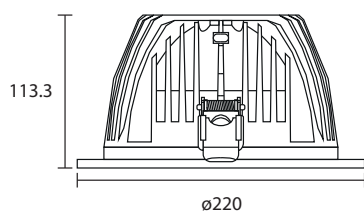

คุณสมบัติ

- ระบายความร้อนได้ดี
- ประสิทธิภาพส่องสว่างสูงถึง 105 lm/W
- ระดับการกันน้ำกันฝุ่น IP44

ประโยชน์ที่ได้รับ

- อายุการใช้งานนานกว่าโคมหลอดตะเกียบ 5 เท่า
- สามารถติดตั้งแทนโคมดวงนี้โคมขนาดเดียวกันได้ทันที
- ประหยัดไฟขึ้น 60% เมื่อเทียบกับหลอดตะเกียบ
- ป้องกันความชื้นได้ดี

รายละเอียดสินค้า	POWER FACTOR (PF)	LUMINOUS FLUX (Lumen)	COLOR TEMP. (Kelvin)	อายุการใช้งาน (ชั่วโมง)
LED-DOP210-29W	0.95	2300	3000K	30,000
LED-DOP210-29D	0.95	2500	4000K	30,000
LED-DOP210-29C	0.95	2700	5700K	30,000
LED-DOP210-42W	0.95	3300	3000K	30,000
LED-DOP210-42D	0.95	3700	4000K	30,000
LED-DOP210-42C	0.95	4200	5700K	30,000

LED-DL_/LTO LED-DH_/LTO

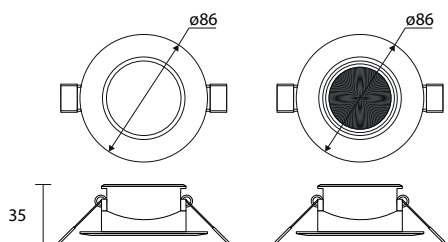
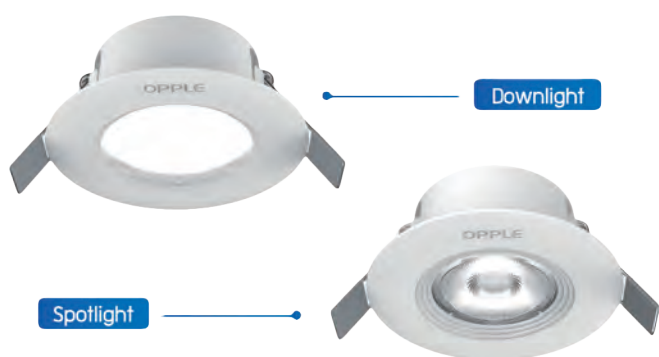

คุณสมบัติ

- ไร้ลำแสงเขม
- ใช้งานง่าย
- ประหยัดพลังงาน

ประโยชน์ที่ได้รับ

- ใช้เลนส์ TIR ซึ่งเป็นเทคโนโลยีไร้ลำแสงเขม
- ทำให้ไม่เกิดเงาซ้อน
- ติดตั้งง่ายภายในชั้นตอนเดียว
- ประหยัดไฟสูงสุดถึง 85% เมื่อเทียบกับหลอดฮาโลเจนขนาด 35 วัตต์

รายละเอียดสินค้า	POWER FACTOR (PF)	LUMINOUS FLUX (Lumen)	COLOR TEMP. (Kelvin)	อายุการใช้งาน (ชั่วโมง)
LED-DL4.5W/OP	0.5	250	3000K	20,000
LED-DL4.5C/OP	0.5	250	4000K	20,000
LED-DL4.5D/OP	0.5	250	5700K	20,000
LED-DH4.5W/OP	0.5	300	3000K	20,000
LED-DH4.5C/OP	0.5	300	4000K	20,000
LED-DH4.5D/OP	0.5	300	5700K	20,000

LED-TRL

UTILITY TRACK SPOTLIGHT



BK

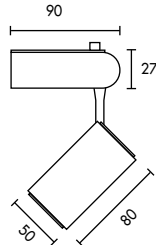
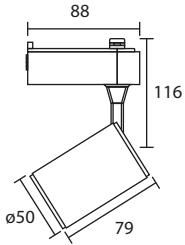

LED-TRM

UTILITY TRACK SPOTLIGHT

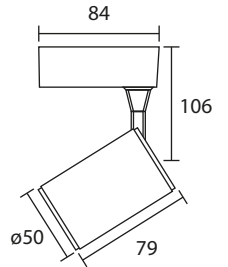

TRL-FSL25W/WH

LED TRACK LIGHT

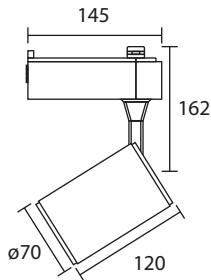

TRL-FSL35W/WH

LED TRACK LIGHT

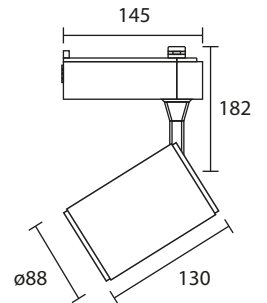

คุณสมบัติ

- ใช้ CHIP LED คุณภาพสูง
- เลนส์กระจายแสงที่ออกแบบมาเป็นพิเศษ
- โครงสร้างผลิตจากอลูมิเนียมเนื้อดี
- ระบายความร้อนได้ดี
- มีความยืดหยุ่น ปรับได้ทั้งแนวตั้งและแนวนอน

ประโยชน์ที่ได้รับ

- มุมกระจายแสงกว้างถึง ปราศจากจุดมืด
- CHIP LED มีประสิทธิภาพสูง เพื่อความสะดวกสบายสูงสุดของการมอง
- มีความยืดหยุ่น ช่วยเน้นสินค้าโชว์ตามมุมต่างๆ



รายละเอียดสินค้า	POWER FACTOR (PF)	LUMINOUS FLUX (Lumen)	COLOR TEMP. (Kelvin)	อายุการใช้งาน (ชั่วโมง)
LED-TRL5W/WH,BK/OP	0.5	250	3000K	20,000
LED-TRL5D/WH,BK/OP	0.5	250	6500K	20,000
LED-TRL7W/WH,BK/OP	0.5	350	3000K	20,000
LED-TRL7D/WH,BK/OP	0.5	350	6500K	20,000
LED-TRM5W/WH/OP	0.5	250	3000K	20,000
LED-TRM5D/WH/OP	0.5	250	6500K	20,000
LED-TRM7W/WH/OP	0.5	350	3000K	20,000
LED-TRM7D/WH/OP	0.5	350	6500K	20,000
TRL-FSL25W/WH	0.5	1800	3000K	25,000
TRL-FSL25W/WH	0.5	2600	3000K	25,000

LED-FLO-E/OP

FLOOD LIGHT ECOMAX II

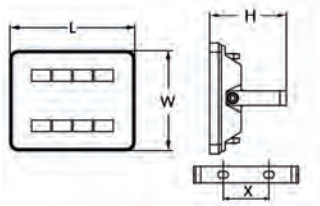

DIMENSIONAL

	L	W	H	X
50W	200	140	99	60
100W	280	220	135	80

คุณสมบัติ

- ออกแบบให้มีขนาดบางและระกักรัดเป็นพิเศษ
- โครงสร้างแข็งแรงทนทาน เคลือบและอบด้วยสีพิเศษ
- ระดับการกันน้ำ กันฝุ่น IP65
- ระดับป้องกันการกระแทก IK08
- ประสิทธิภาพการส่องสว่างสูงถึง 80 LM/W
- ประหยัดไฟสูงสุด 50% และอายุการใช้งานยาวนาน

รายละเอียดสินค้า

	POWER FACTOR (PF)	LUMINOUS FLUX (Lumen)	COLOR TEMP. (Kelvin)	อายุการใช้งาน (ชั่วโมง)
LED-FLO-E50W/OP	0.95	4000	3000K	30,000
LED-FLO-E50C/OP	0.95	4100	4000K	30,000
LED-FLO-E50D/OP	0.95	4200	6000K	30,000
LED-FLO-E100W/OP	0.95	9200	3000K	30,000
LED-FLO-E100C/OP	0.95	9300	4000K	30,000
LED-FLO-E100D/OP	0.95	9400	6000K	30,000

LED-FLO20/OP

FLOOD LIGHT PERFORMER (MINI)

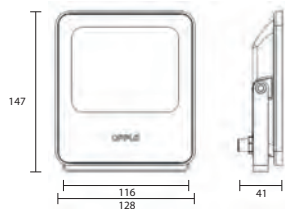

คุณสมบัติ

- ออกแบบให้มีขนาดบางและระกักรัดเป็นพิเศษ
- โครงสร้างแข็งแรงทนทาน พร้อมไดรเวอร์ภายในวงจร
- ระดับการกันน้ำ กันฝุ่น IP65
- ระดับป้องกันการกระแทก IK08
- ประสิทธิภาพการส่องสว่างสูงถึง 100 LM/W

รายละเอียดสินค้า

	POWER FACTOR (PF)	LUMINOUS FLUX (Lumen)	COLOR TEMP. (Kelvin)	อายุการใช้งาน (ชั่วโมง)
LED-FLO20W/OP	0.98	1600	3000K	25,000
LED-FLO20C/OP	0.98	1600	4000K	25,000
LED-FLO20D/OP	0.98	1600	6000K	25,000

LED-FLO50/OP

FLOOD LIGHT PERFORMER

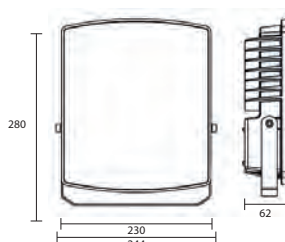

คุณสมบัติ

- มีรูปลักษณ์เฉพาะตัว
- ตัวโคมทำจากอลูมิเนียมอัลลอยด์
- เคลือบและอบด้วยสีพิเศษ
- ประหยัดไฟสูงสุด 50% และอายุการใช้งานยาวนาน
- ระดับการกันน้ำ กันฝุ่น IP65

รายละเอียดสินค้า

	POWER FACTOR (PF)	LUMINOUS FLUX (Lumen)	COLOR TEMP. (Kelvin)	อายุการใช้งาน (ชั่วโมง)
LED-FLO50W/OP	0.9	3255	3000K	25,000
LED-FLO50C/OP	0.9	3350	4000K	25,000
LED-FLO50D/OP	0.9	3500	6000K	25,000



LED-WB-Q/OP
STREET LIGHT



คุณสมบัติ

- แรงดันไฟฟ้ากว้าง
- ระบายความร้อนได้ดี
- ประสิทธิภาพการส่องสว่างสูงและไม่มีแสงแยงตา
- ระดับการกันน้ำ กันฝุ่น IP65
- มีระบบป้องกันไฟกระชากแรงดันถึง 5KV

ประโยชน์ที่ได้รับ

- กระจายแสงได้ทั่วถึง เพิ่มประสิทธิภาพในการมองเห็น
- ปลอดภัยเมื่อใช้ภายนอกอาคาร เนื่องจากถูกออกแบบมาให้ทนทุกสภาวะอากาศ
- ประหยัดไฟสูงสุดถึง 60% เมื่อเทียบกับโคมถนนทั่วไป
- อายุการใช้งานยาวนาน ต้นทุนในการดูแลรักษาต่ำ

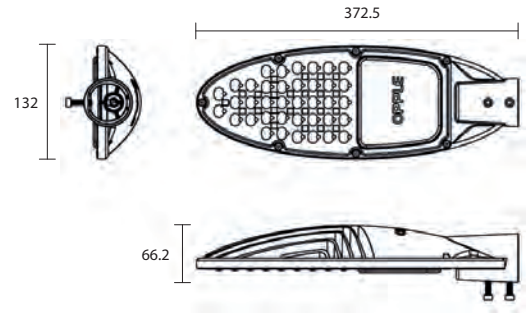

รายละเอียดสินค้า	POWER FACTOR (PF)	LUMINOUS FLUX (Lumen)	COLOR TEMP. (Kelvin)	อายุการใช้งาน (ชั่วโมง)
LED-WB-Q40W/OP	0.95	3680	3000K	30,000
LED-WB-Q40C/OP	0.95	3920	4000K	30,000
LED-WB-Q40D/OP	0.95	4000	5700K	30,000

LED-WB-E/OP
STREET LIGHT ECOMAX



คุณสมบัติ

- ระบายความร้อนได้ดี
- ประสิทธิภาพการส่องสว่างสูงและไม่มีแสงแยงตา
- ระดับการกันน้ำ กันฝุ่น IP65
- ระดับป้องกันการกระแทก IK08 และทนทานต่อการสั่นสะเทือน 3G
- มีระบบป้องกันไฟกระชากแรงดันถึง 5KV

ประโยชน์ที่ได้รับ

- กระจายแสงได้ทั่วถึง เพิ่มประสิทธิภาพในการมองเห็น
- ปลอดภัยเมื่อใช้ภายนอกอาคาร เนื่องจากถูกออกแบบมาให้ทนทุกสภาวะอากาศ
- ประหยัดไฟสูงสุดถึง 60% เมื่อเทียบกับโคมถนนทั่วไป
- อายุการใช้งานยาวนาน ต้นทุนในการดูแลรักษาต่ำ

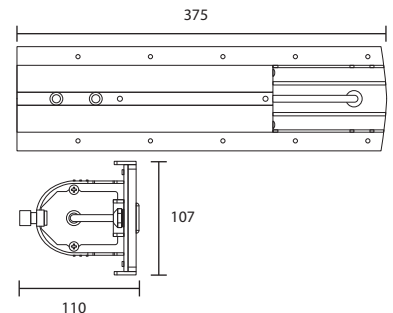

รายละเอียดสินค้า	POWER FACTOR (PF)	LUMINOUS FLUX (Lumen)	COLOR TEMP. (Kelvin)	อายุการใช้งาน (ชั่วโมง)
LED-WB-E30W/OP	0.95	3000	3000K	30,000
LED-WB-E30C/OP	0.95	3150	4000K	30,000
LED-WB-E30D/OP	0.95	3300	5700K	30,000
LED-WB-E60W/OP	0.95	6000	3000K	30,000
LED-WB-E60C/OP	0.95	6300	4000K	30,000
LED-WB-E60D/OP	0.95	6600	5700K	30,000

LED-PAR

หลอด PAR รุ่นประหยัด แต่คุณภาพเท่าเดิม มาพร้อมกัน BODY สีขาวสะอาดตา มาพร้อมเทคโนโลยีหลอด 3030 EPISTAR ที่ทำให้หลอดมีความคงทนยาวนาน



LED-LP3815W/LTO



500.-

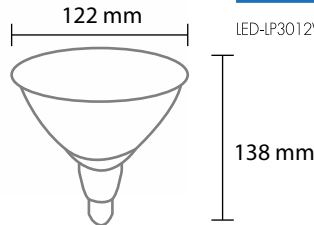

รายละเอียดสินค้า	COLOR TEMP. (Kelvin)	WATT	WORKING VOLTAGE	LUMINOUS FLUX (Lumen)	BEAM ANGLE	อายุการใช้งาน (ชั่วโมง)
LED-LP3012W/OH	32K WARM WHITE	15W	AC 1175-266V.	1,500 LM	38 DEG.	25,000

LED-LP3012W/OH



520.-

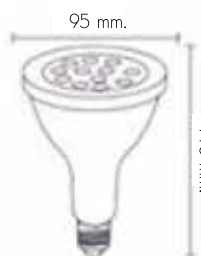

รายละเอียดสินค้า	COLOR TEMP. (Kelvin)	WATT	WORKING VOLTAGE	LUMINOUS FLUX (Lumen)	BEAM ANGLE	อายุการใช้งาน (ชั่วโมง)
LED-LP3012W/OH	32K WARM WHITE	12W	AC 1175-266V.	1,080-1,200 LM	38 DEG.	25,000

LED-LG41.5W/OH



G40002-0105-32K
LED G4 360Deg 12v
1.5W IP20 360° G4 12v

LED-LG92.5 W/OH



G90002-0205-32K
LED G9 360Deg 220-240v
2.5W IP20 360° G9

LED-LQR12/_DIM/OP

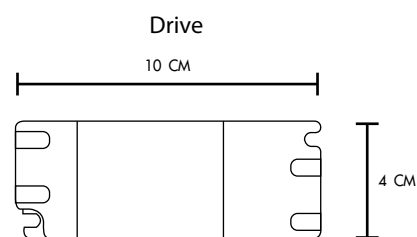
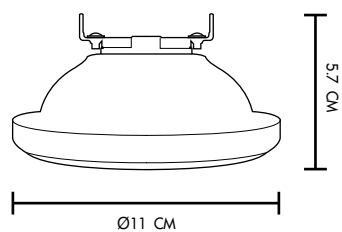
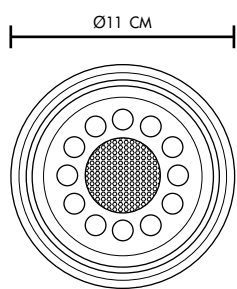

รายละเอียดสินค้า

	COLOR TEMP. (Kelvin)	LUMINOUS FLUX (Lumen)	DIMMABLE
LED-LQR12/27DIM/OP	2700K	1200	YES
LED-LQR12/30DIM/OP	3000K	1200	YES
LED-LQR12/40DIM/OP	4000K	1200	YES
LED-LQR12/57DIM/OP	5700K	1200	YES

LED-CORN BULB

CORN LIGHT BULB มาพร้อมด้วยรูปทรงที่มีเอกลักษณ์และดีไซน์แบบใหม่ สามารถตัดแสงที่รบกวนสายตา ให้แสงที่นุ่มนวล และแสงเย็นสบาย ปราศจากรังสี UV ทางเรามีให้เลือกหลายรุ่นเพื่อตอบสนองความต้องการให้เหมาะกับสไตล์ของคุณ พร้อมมั่นใจในราคาและคุณภาพสินค้าของเราได้อย่างไม่ต้องกังวล

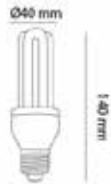

LED-LE7W/LTO

LED E27 CORNBULB

3U 7w IP20 E27 3U

รายละเอียดสินค้า	COLOR TEMP. (Kelvin)	WATT	WORKING VOLTAGE	LUMINOUS FLUX (Lumen)	BEAM ANGLE	อายุการใช้งาน (ชั่วโมง)
LED-LE7W/LTO	WARM WHITE	7W	AC 110-240V.	630-700 LM	360 DEG.	15,000

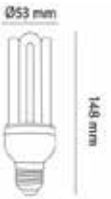

LED-LE12W/LTO

LED E27 CORNBULB

3U 12w IP20 E27 3U

รายละเอียดสินค้า	COLOR TEMP. (Kelvin)	WATT	WORKING VOLTAGE	LUMINOUS FLUX (Lumen)	BEAM ANGLE	อายุการใช้งาน (ชั่วโมง)
LED-LE12W/LTO	3,000K WARM WHITE	12W	AC 110-240V.	1,080-1,120 LM	360 DEG.	15,000

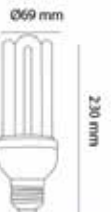

LED-LE24W/LTO

LED E27 CORNBULB

4U 24w IP20 E27 4U

รายละเอียดสินค้า	COLOR TEMP. (Kelvin)	WATT	WORKING VOLTAGE	LUMINOUS FLUX (Lumen)	BEAM ANGLE	อายุการใช้งาน (ชั่วโมง)
LED-LE24W/LTO	WARM WHITE	24W	AC 110-240V.	2,160-2,400 LM	360 DEG.	15,000



LED-LE30W/LTO

LED E27 CORNBULB

4U 30w IP20 E27 4U

รายละเอียดสินค้า	COLOR TEMP. (Kelvin)	WATT	WORKING VOLTAGE	LUMINOUS FLUX (Lumen)	BEAM ANGLE	อายุการใช้งาน (ชั่วโมง)
LED-LE30W/LTO	3,000K WARM WHITE	30W	AC 110-240V.	2,700-3,000 LM	360 DEG.	15,000

LED-RIBBON STRIP

LED RIBBON STRIP เหมาะกับการใช้งานที่หลากหลาย ทั้งไฟตู้โชว์สินค้า การซ่อนไฟเพื่อส่องสว่างใต้หลังคา ใช้กับกันสาด โดยเน้นการใช้งานทั้งภายในและภายนอก มีให้เลือกทั้งแบบกันน้ำ และแบบเปลี่ยนสีได้อีกทั้งยังให้แสงที่เย็นปราศจากรังสี UV และมีอายุการใช้งานที่ยาวนาน

ห้ามใช้กับกระแสไฟ 220v ให้ใช้พ่วงกับเต้าเสียบ 12v เท่านั้น
*****ใช้ร่วมกับ Switching หรือ Power Supply**

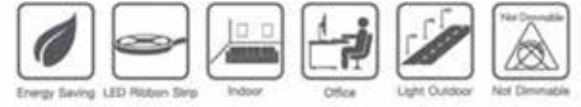

LED RIBBON STRIP 5050



LED-RB60W/5050/20

5050

IP20 12v IP20 NK 5050

รายละเอียดสินค้า	COLOR TEMP. (Kelvin)	WATT	WORKING VOLTAGE	LUMINOUS FLUX (Lumen)	BEAM ANGLE	อายุการใช้งาน (ชั่วโมง)
LED-RB60W/5050/20	3,000 K WARM WHITE	14.4W/M.	DC 12V.	840 LM	120 DEG.	25,000

IP20 Naked / แบบเปลือย

IP65 With Silicon Tube / ท่อซิลิโคนกันน้ำ กันฝุ่น
 Application examples ตัวอย่างการใช้งาน

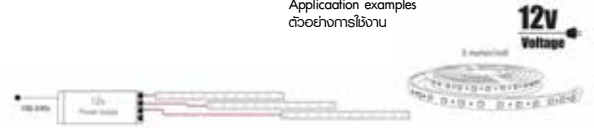

LED-RB60W/5050/67

5050

IP67 12v IP67 UC 5050

รายละเอียดสินค้า	COLOR TEMP. (Kelvin)	WATT	WORKING VOLTAGE	LUMINOUS FLUX (Lumen)	BEAM ANGLE	อายุการใช้งาน (ชั่วโมง)
LED-RB60W/5050/67	3,000 K WARM WHITE	14.4W/M.	DC 12V.	12-14 LM/LED	120 DEG.	25,000

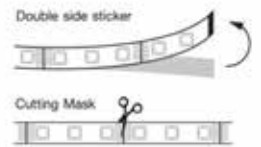

สามารถใช้ร่วมกับ ALUMINIUM BAR

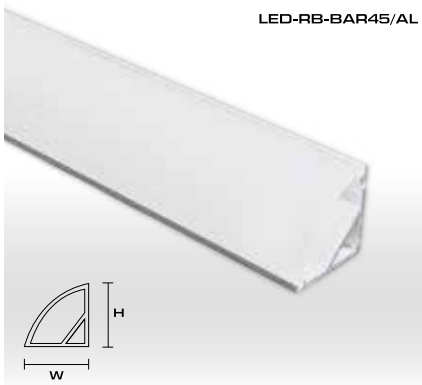

PRODUCT NAME	DIMENSION	USE FOR	PRICE/M
LED-RB-BAR45/AL	16 X 16 mm	i-RIBBON WIDTH UP TO 10 mm	
LED-RB-BAR-R/AL	25 X 7 mm	i-RIBBON WIDTH UP TO 12 mm	
LED-RB-BAR/AL	15 X 0.9 mm	i-RIBBON WIDTH UP TO 10 mm	

LED-L22-18/_/OP

ECOMAX CEILING MODULE (C MODULE)



รายละเอียดสินค้า	POWER FACTOR (PF)	LUMINOUS FLUX (Lumen)	COLOR TEMP. (Kelvin)	อายุการใช้งาน (ชั่วโมง)
LED-L22-18/65/OP	0.7	1500	6500k	25,000
LED-L22-18/30/OP	0.7	1500	3000k	25,000

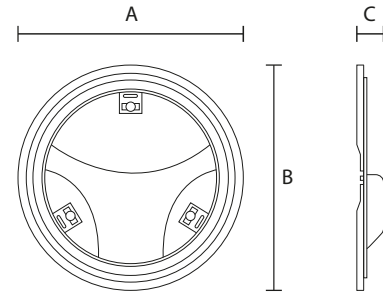

DIMENSIONAL

A (mm)	191
B (mm)	191
C (mm)	28.7

LED-L32-22/_/OP

ECOMAX CEILING MODULE (C MODULE)



รายละเอียดสินค้า	POWER FACTOR (PF)	LUMINOUS FLUX (Lumen)	COLOR TEMP. (Kelvin)	อายุการใช้งาน (ชั่วโมง)
LED-L32-18/65/OP	0.7	1900	6500k	25,000
LED-L32-18/30/OP	0.7	1900	6500k	25,000

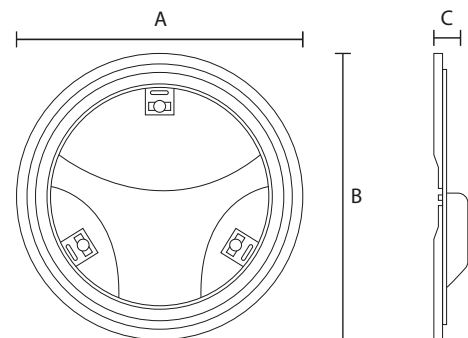

DIMENSIONAL

A (mm)	228
B (mm)	228
C (mm)	29

คุณสมบัติ

- ใช้แม่เหล็กสำหรับยึดติดโคมคุณภาพสูง
- เลนส์กระจายแสงได้เน้นการออกแบบมาเป็นพิเศษ
- เปิดติดทันทีไม่มีกระพริบ
- ประหยัดพลังงาน

ประโยชน์ที่ได้รับ

- ใช้ทดแทนหลอดฟลูออโรเรสเซนต์
- กระจายแสงทั่วถึง ปราศจากจุดมืด
- เปิดติดได้เมื่ออยู่ในพื้นที่ๆมีอุณหภูมิต่ำ
- ประหยัดไฟสูงสุดถึง 60%เมื่อเทียบกับหลอดฟลูออโรเรสเซนต์แบบเดิม



LED-RB-BAR35

STANDARD ACCESSORIES

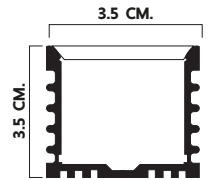
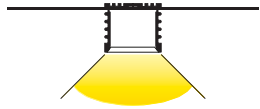
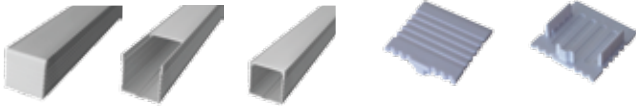

סטנד 2 כרע

LED-RB-BAR-R35

STANDARD ACCESSORIES

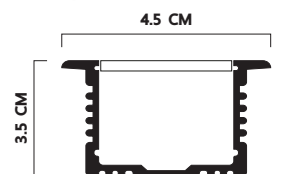
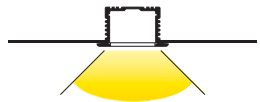
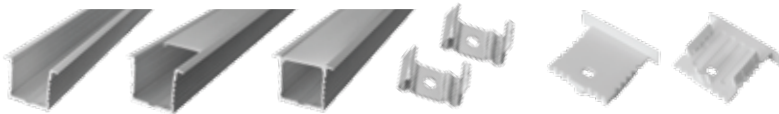

סטנד 2 כרע

LED STRIP LIGHT

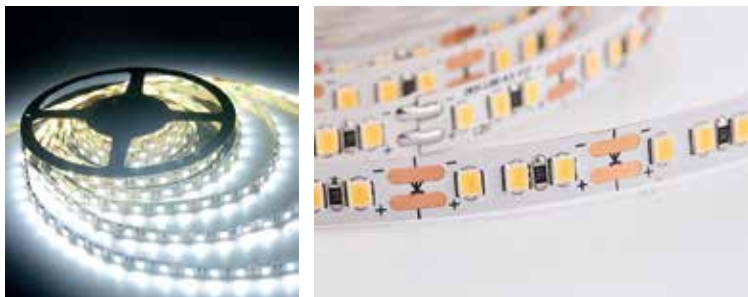

LAMP : STEP LIGHT 2835 (6W/M)
580-960 LUMEN/M

: STEP LIGHT 2835 (12W/M)
1300-1380 LUMEN/M

(סר LED יא 2 סעו)

COLOUR TEMPERATURE : 2400K ,2700K ,3000K ,4000K ,6500K
TRANSFORMER : SWITCHING POWER SUPPLY 12 VDC.



LED-RB-BAR-H35

STANDARD ACCESSORIES

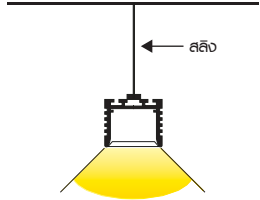
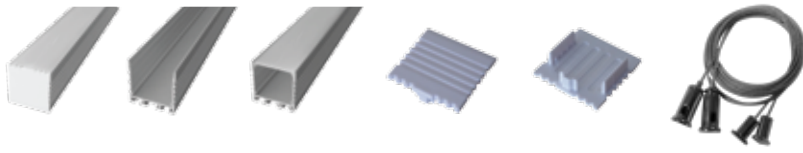

↑
ติดตั้งหัวบาร์

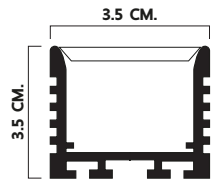

ยว 2 มม

LED STRIP LIGHT

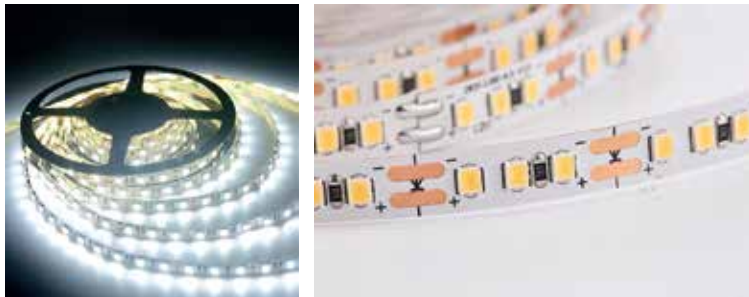

LAMP : STEP LIGHT 2835 (6W/M)
580-960 LUMEN/M

: STEP LIGHT 2835 (12W/M)
1300-1380 LUMEN/M

(ใส่ LED ได้ 2 เส้น)

COLOUR TEMPERATURE : 2400K ,2700K ,3000K ,4000K ,6500K

TRANSFORMER : SWITCHING POWER SUPPLY 12 VDC.



LED-RB-BAR-45

STANDARD ACCESSORIES

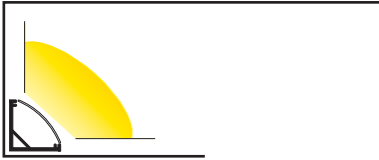

ขนาด 45 มม

LED STRIP LIGHT

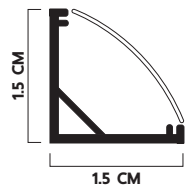
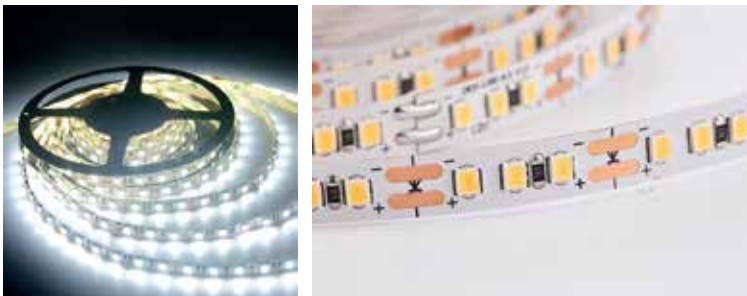

ขนาด 1.5 CM

LAMP : STEP LIGHT 2835 (6W/M)
580-960 LUMEN/M

: STEP LIGHT 2835 (12W/M)
1300-1380 LUMEN/M

(ใส่ LED ได้ 1 เส้น)

COLOUR TEMPERATURE : 2400K ,2700K ,3000K ,4000K ,6500K

TRANSFORMER : SWITCHING POWER SUPPLY 12 VDC.



เหมาะกับการใช้งาน

- ตู้โชว์สินค้า
- โฟตอนพา
- โฟโต้โมบิล
- โฟโต้สตาร์



LED-RB-BAR15

STANDARD ACCESSORIES

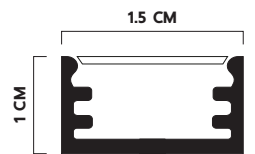
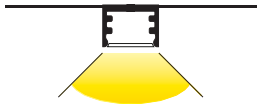
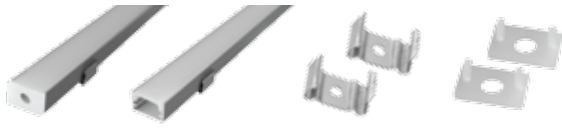

סטאנ 1 כרע

LED-RB-BAR-R15

STANDARD ACCESSORIES

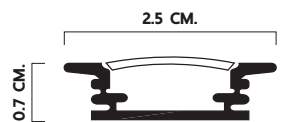
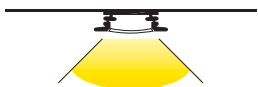

סטאנ 1 כרע

LED STRIP LIGHT

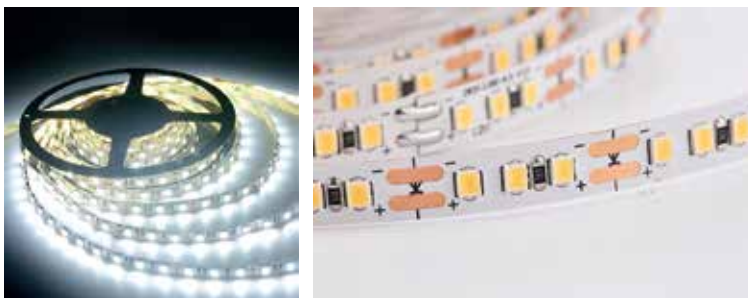

LAMP : STEP LIGHT 2835 (6W/M)
580-960 LUMEN/M

: STEP LIGHT 2835 (12W/M)
1300-1380 LUMEN/M

(ליי LED לוי 1 לעו)

COLOUR TEMPERATURE : 2400K ,2700K ,3000K ,4000K ,6500K

TRANSFORMER : SWITCHING POWER SUPPLY 12 VDC.



LED PANEL SLIM ROUND

ALUMINIUM BODY, WORKING VOLTAGE AC 85-265V, CHIP TYPE EPISTAR
 LUMEN PER WATT 85-90 LM/WATT, BEAM ANGLE 120 DEG
 LIFE TIME 25,000 Hrs.



(3 Step)

LED-PN012+4/LTO

EPISTAR 2835 SMD LED CHIP
 960LM+320LM
 220V,AC, 50/60HZ
 560.-

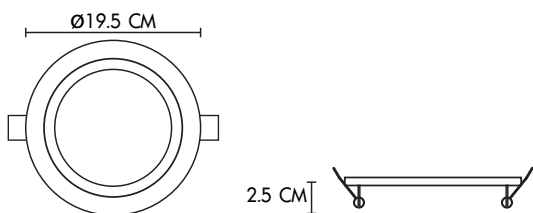

Step 1

12w6000k + 4w3000k

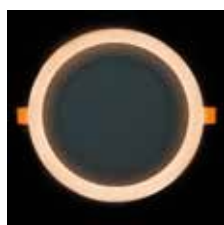

Step 2

4w3000k



Step 3

12w6000K 960lm



мод. 1955-2551



SOLAR-BOL25/LTO

แสงวอร์ม
เวลาการทำงาน 8-14 ชั่วโมง
LED 1.6W
Aluminium + pc

3,200.-



SOLAR-BOL25/LTO

แสงวอร์ม
เวลาการทำงาน 8-14 ชั่วโมง
LED 1.6W
Aluminium + pc

2,800.-

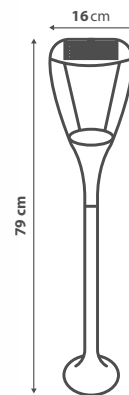
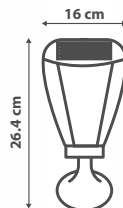



SOLAR-BOL11680/LTO

แสงวอร์ม
Motion Sensor
เวลาการทำงาน 8-14 ชั่วโมง
LED 2.5W
Aluminium + pc

6,400.-

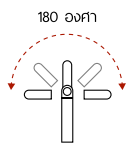
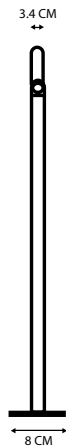
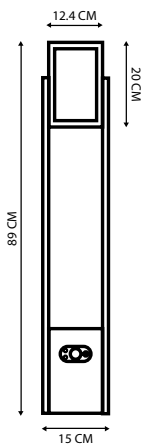

*สามารถปรับระดับการใช้งานได้ 180 องศา

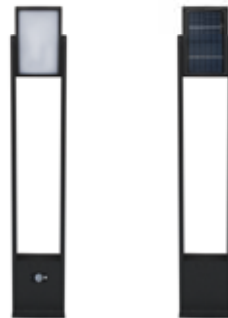



SOLAR-STEP06/LTO

แสงวอร์ม
เวลาการทำงาน 8-14 ชั่วโมง
LED 1W
Aluminium

1,700.-

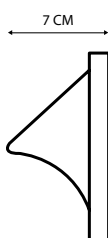
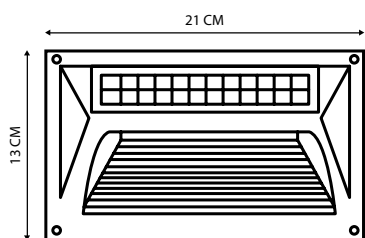



SOLAR-FLO100/LTO

แสงอาทิตย์
Motion Sensor
เวลาการทำงาน 8-14 ชั่วโมง
LED 5 W
Aluminium + pc

4,900.-

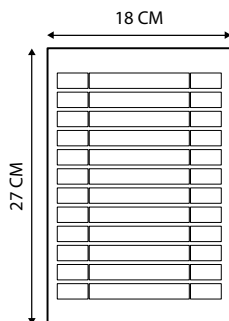
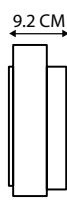
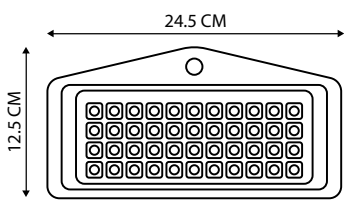

?? ???? 3.5 ???? ?



SOLAR-IN01/LTO

แสงแดด
Motion Sensor
เวลาการทำงาน 8-14 ชั่วโมง
LED 0.5 W
Aluminium

1,320.-

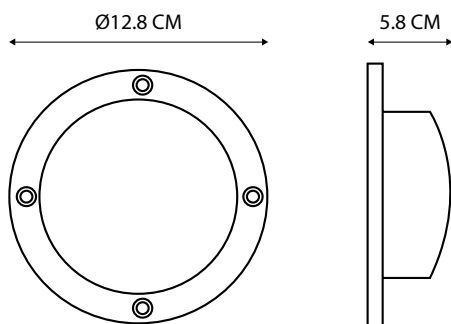

SOLAR-PT-MS012

แสงดัด/วงรูป
Solar 18v/28w
เวลาการทำงาน 18-24 ชั่วโมง
LED 12W
Aluminium + pc

20,000.-

(ราคาเฉพาะโคมไม่รวมเสา)

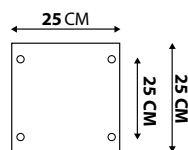
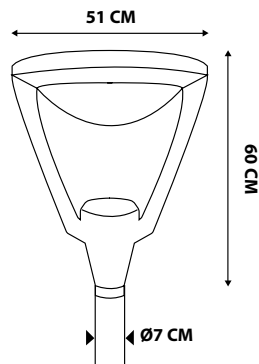



SOLAR-PT-MS010

หลอดไฟ/วงจร
Solar 18v/28w
เวลาการทำงาน 18-24 ชั่วโมง
LED 12W
Aluminium + pc

20,000.-

(ราคาเฉพาะโคมไม่รวมเสา)

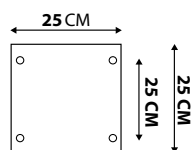
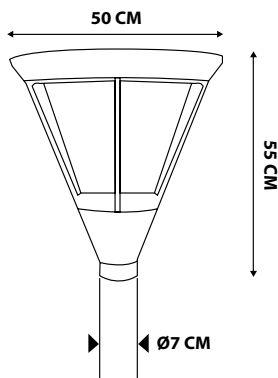

SOLAR-PT-MS005

แสงตัด/วอร์ม
Solar 18v/28w
เวลาทำงาน 18-24 ชั่วโมง
LED 12W
Aluminium + pc

20,000.-

(ราคาเฉพาะโคมไม่รวมเสา)

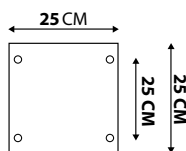
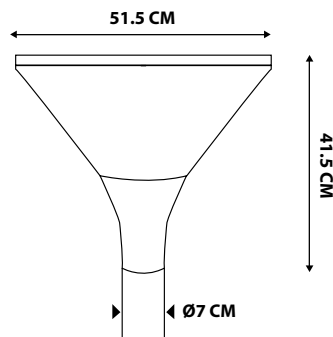



SOLAR-PT-MS013

แสงดัดย้/วงร่
Solar 18v/28w
เวลาการทำงาน 18-24 ชั่วโมง
LED 12W
Aluminium + pc

20,000.-

(ราคาเฉพาะโคมไม่รวมเสา)

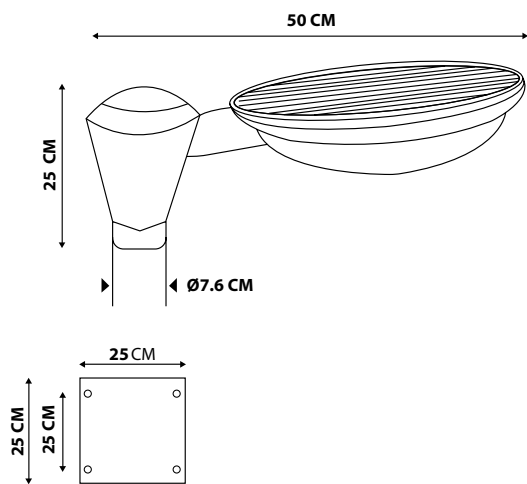



SOLAR-WB-AI0003/15

แสงดัด
Motion Sensor
เวลาการทำงาน 18-24 ชั่วโมง
LED 15W

15,000.-

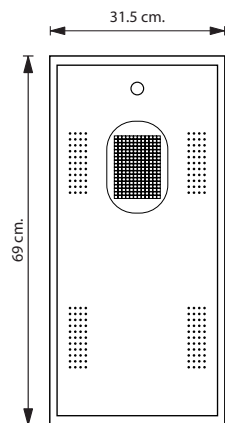



EZY-SOLAR-W04-0.5W

แสงดอญ
Motion Sensor
เวลาการทำงาน 8-12 ชั่วโมง
LED 15 ดวง

560.-

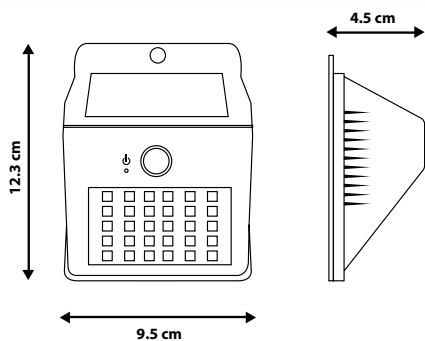

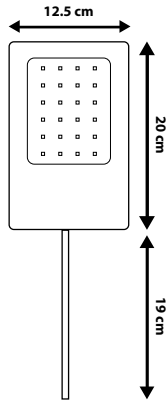

EZY-SOLAR-W08-10W(ZYC)

แสงดอຍ
เวลาการทำงาน 8-10 ชั่วโมง
LED 24 ดวง
(มาตรฐาน)

750.-

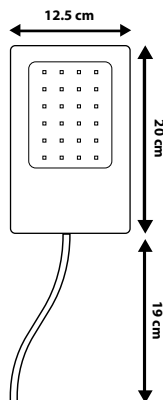

EZY-SOLAR-W08-10W

แสงดอຍ
เวลาการทำงาน 8-10 ชั่วโมง
LED 24 ดวง
(มาตรฐาน)

740.-



EZY-SOLAR-W06-2W

แสงดอญ
Motion Sensor
เวลาการทำงาน 8-12 ชั่วโมง
LED 20 ดวง

720.-

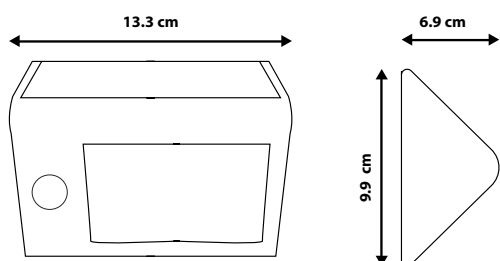



EZY-SOLAR-W07-5W/BK

แสงอาทิตย์
Motion Sensor
เวลาการทำงาน 8-12 ชั่วโมง
LED 36 ดวง

1,200.-

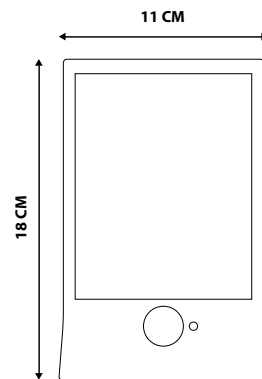



EZY-SOLAR-W09-38/BK

แสงอาทิตย์
Motion Sensor
เวลาการทำงาน 8-12 ชั่วโมง
LED 38 ดวง

960.-

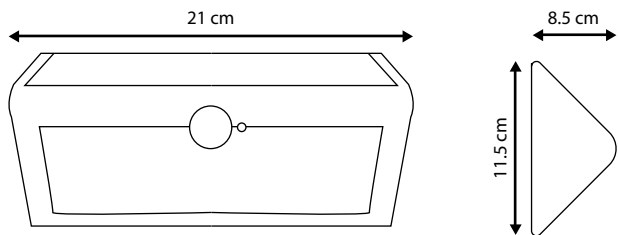



EZY-SOLAR-W10-24/BK

แสงคู่ไวท์
Motion Sensor
เวลาการทำงาน 8-12 ชั่วโมง
LED 24 ดวง

960.-

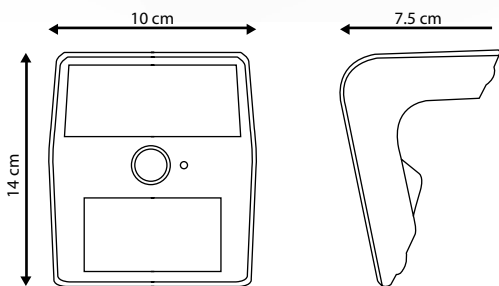



EZY-SOLAR-W11-46/BK

แสงทูลอริ
Motion Sensor
เวลาการทำงาน 8-12 ชั่วโมง
LED 46 ดวง

1,160.-

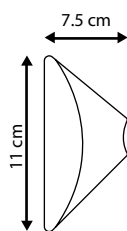
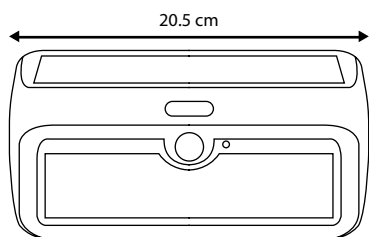



EZY-SOLAR-KIT/RGB

แสง RGB
Motion Sensor
เวลาการทำงาน 8-9 ชั่วโมง
LED 7 ดวง

780.-



EZY-SOLAR-KIT/D

แสงใส
Motion Sensor
เวลาการทำงาน 8-9 ชั่วโมง
LED 7 ดวง

780.-



EZY-SOLAR-KIT/W

แสงวอร์ม
Motion Sensor
เวลาการทำงาน 8-9 ชั่วโมง
LED 7 ดวง

780.-

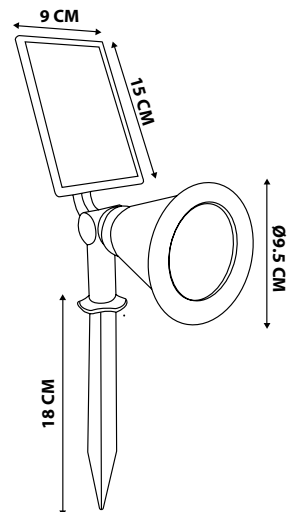



EZY-SOLAR-FL10-KIT

แสงดย
เวลาการทำงาน 8-12 ชั่วโมง
LED 30 ดวง

1,900.-

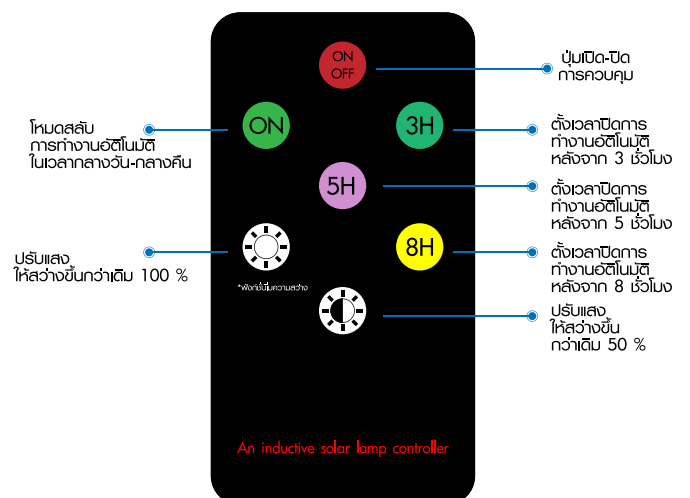
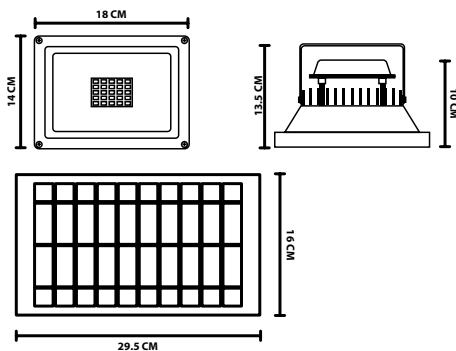



EZY-SOLAR-RST/BL

แสงน้ำเงิน
เวลาการทำงาน 72 ชั่วโมง
LED 6 ดวง

700.-

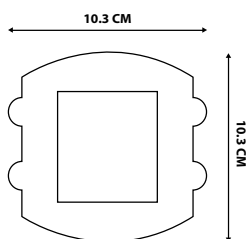

EZY-SOLAR-RST/OR

แสงวอร์ม
เวลาการทำงาน 72 ชั่วโมง
LED 6 ดวง

700.-

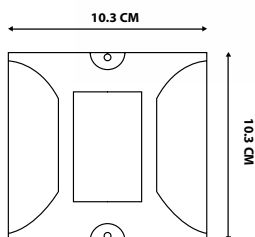



SOLAR-BOR-PV-G014
LED power 1.8w
Aluminium

5,400.-

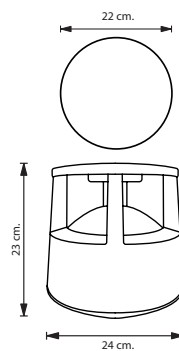



SOLAR-BOL-PV-G005
LED power 1.8w
Aluminium/pc

5,800.-

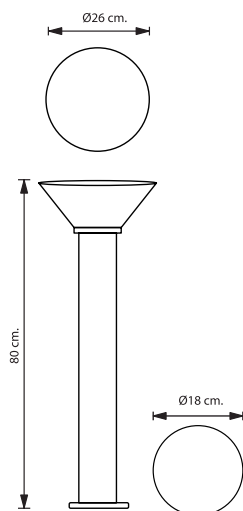



SOLAR-BOL-PV-G011
LED power 4w
Aluminium/pc

8,400.-

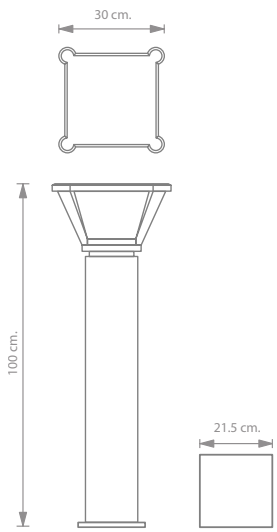





600.- (เฉพาะกล่อง+E27)
670.- (เฉพาะกล่อง+E40)

HA-01

HOUSING : STEEL
PAINTING : WHITE POWDER COAT

COMPATIBLE BULB			
	MH / E27 70W / 150W		MH / E40 250W / 400W

พร้อมอุณหรั (BL+IG+CAPA)	CROSS
E27 HA01/MH70	1,680.-
HA01/MH150	1,920.-
E40 HA01/MH250	2,000.-
HA01/MH400	2,300.-



1,400.- (เฉพาะกล่อง+E27)
1,470.- (เฉพาะกล่อง+E40)

HA-02

HOUSING : EXTRUDED ALUMINIUM
PAINTING : ALUMINIUM COLOUR

COMPATIBLE BULB			
	MH / E27 70W / 150W		MH / E40 250W / 400W

พร้อมอุณหรั (BL+IG+CAPA)	CROSS
E27 HA02/MH70	2,430.-
HA02/MH150	2,670.-
E40 HA02/MH250	2,750.-
HA02/MH400	3,050.-

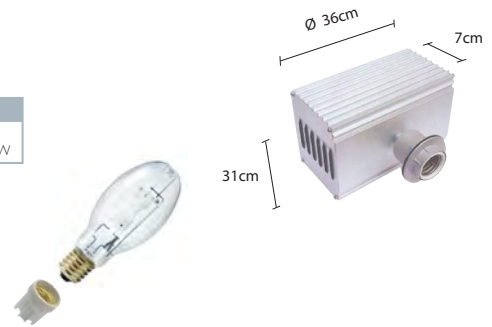

1,400.- (เฉพาะกล่อง+E27)
1,470.- (เฉพาะกล่อง+E40)

HA-05

HOUSING : EXTRUDED ALUMINIUM
PAINTING : ALUMINIUM COLOUR

COMPATIBLE BULB			
	MH / E27 70W / 150W		MH / E40 250W / 400W

พร้อมอุณหรั (BL+IG+CAPA)	CROSS
E27 HA05/MH70	2,430.-
HA05/MH150	2,670.-
E40 HA05/MH250	2,750.-
HA05/MH400	3,050.-

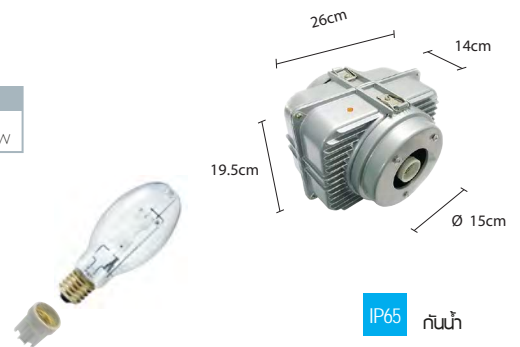

HA-E27

400.-

HA-E40

470.-

ราคาตัวพร้อมโซ่ยาว 1 เมตร

COMPATIBLE BULB			
	TORNADO / E27 45W / 65W		TORNADO / E40 110W





HB-01

โคมไฮเบย์สายเพชร 14 นิ้ว

MATERIAL : ALUMINIUM



HB-03

โคมไฮเบย์สายเพชร 14 นิ้ว

MATERIAL : ALUMINIUM



HB-04

โคมไฮเบย์สายสาธุ 16 นิ้ว

MATERIAL : ALUMINIUM



HB-05

โคมไฮเบย์สายพ่นทราย 16 นิ้ว

MATERIAL : ALUMINIUM



HB-02

โคมไฮเบย์สายเพชรครึ่งใบ 16 นิ้ว

MATERIAL : ALUMINIUM

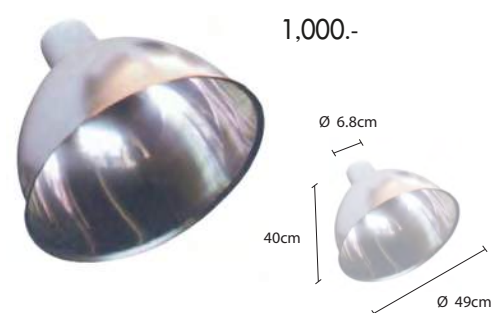

HB-06

โคมไฮเบย์สายปิดเงา 18 นิ้ว

MATERIAL : ALUMINIUM

HB-02/G

โคมไฮเบย์สายเพชรครึ่งใบ 16 นิ้ว+กระจก

MATERIAL : ALUMINIUM

1,600.-

HB-06/G

โคมไฮเบย์สายปิดเงา 18 นิ้ว+กระจก

MATERIAL : ALUMINIUM

2,300.-



HA-E27 HB-12

REFLECTOR : ALUMINIUM
INSTALLATION : FLANGING

COMPATIBLE BULB	
	TORNADO / E27 45W

950.-



HA-E27 HB-05

REFLECTOR : ALUMINIUM
INSTALLATION : FLANGING

COMPATIBLE BULB	
	TORNADO / E27 45W

960.-



HA-02 HB-01

REFLECTOR : ALUMINIUM
GEARBOX : EXTRUDED ALUMINIUM
MOUNTING : HOOK OR CHAIN SUSPENSION

COMPATIBLE BULB			
	MH / E27 70W / 150W		MH / E40 250W / 400W

1,980.- (ປັບ E27)



HA-02 HB-03

REFLECTOR : ALUMINIUM
GEARBOX : EXTRUDED ALUMINIUM
MOUNTING : HOOK OR CHAIN SUSPENSION



COMPATIBLE BULB			
	MH / E27 70W / 150W		MH / E40 250W / 400W

1,980.- (ປັບ E27)



HA-05 HB-06/G

REFLECTOR : ALUMINIUM
GEARBOX : DIE-CAST ALUMINIUM
MOUNTING : HOOK OR CHAIN SUSPENSION

COMPATIBLE BULB			
	MH / E27 70W / 150W		MH / E40 250W / 400W

3,770.- (ປັບ E40 ສວນຈາກ)





HA-00 HB-09

REFLECTOR : UV STABILIZED ACRYLIC
 GEARBOX : EXTRUDED ALUMINIUM
 MOUNTING : HOOK OR CHAIN SUSPENSION

COMPATIBLE BULB	
	MH / E27 70W / 150W

2,100.- (ថ្លៃ E27 ប្រៃសណីយ៍)



HA-02 HB-16

REFLECTOR : UV STABILIZED ACRYLIC
 GEARBOX : EXTRUDED ALUMINIUM
 MOUNTING : HOOK OR CHAIN SUSPENSION

COMPATIBLE BULB			
	MH / E27 70W / 150W		MH / E40 250W / 400W

3,500.- (ថ្លៃ E27) សន្សំ
 3,570.- (ថ្លៃ E40) សន្សំ



HA-05 HB-22

REFLECTOR : UV STABILIZED ACRYLIC
 GEARBOX : DIE-CAST ALUMINIUM
 MOUNTING : HOOK OR CHAIN SUSPENSION

COMPATIBLE BULB	
	MH / E40 400W

4,470.- (ថ្លៃ E40) សន្សំ





TRM-201

Spot light

HOUSING : ALUMINIUM
PAINTING : BLACK AND WHITE

COMPATIBLE BULB	
	MR16 / GX5.3 50W

LED REPLACEMENT	
	LED-MR16 / GX5.3 5W

380.-



(INCLUDED TRANSFORMER)



TRL-201

Track light

HOUSING : ALUMINIUM
PAINTING : BLACK AND WHITE

COMPATIBLE BULB	
	MR16 / GX5.3 50W

LED REPLACEMENT	
	LED-MR16 / GX5.3 5W

380.-



(INCLUDED TRANSFORMER)



TRM-202

Spot light

HOUSING : ALUMINIUM
PAINTING : BLACK AND WHITE

COMPATIBLE BULB	
	MR16 / GX5.3 50W

LED REPLACEMENT	
	LED-MR16 / GX5.3 5W

380.-



(INCLUDED TRANSFORMER)



TRL-202

Track light

HOUSING : ALUMINIUM
PAINTING : BLACK AND WHITE

COMPATIBLE BULB	
	MR16 / GX5.3 50W

LED REPLACEMENT	
	LED-MR16 / GX5.3 5W

380.-



(INCLUDED TRANSFORMER)

TRM-202/ST

PAINTING : NICKLE SATIN

580.-



TRL-202/ST

PAINTING : NICKLE SATIN

580.-



TRM-203

Spot light

- HOUSING : ALUMINIUM
- PAINTING : BLACK AND WHITE

COMPATIBLE BULB	
	MR16 / GX5.3 50W

LED REPLACEMENT	
	LED-MR16 / GX5.3 5W

380.-



(INCLUDED TRANSFORMER)



TRL-203

Track light

HOUSING : ALUMINIUM
PAINTING : BLACK AND WHITE

COMPATIBLE BULB	
	MR16 / GX5.3 50W

LED REPLACEMENT	
	LED-MR16 / GX5.3 5W

380.-



(INCLUDED TRANSFORMER)



TRM-900

Spot light

HOUSING : ALUMINIUM

PAINTING : BLACK AND WHITE

780.-

COMPATIBLE BULB	
	MR16 / GX5.3 50W

LED REPLACEMENT	
	LED-MR16 / GX5.3 5W

(Included Transformer)

BK **WH**



TRL-900

Track light

HOUSING : ALUMINIUM

PAINTING : BLACK AND WHITE

780.-

COMPATIBLE BULB	
	MR16 / GX5.3 50W

LED REPLACEMENT	
	LED-MR16 / GX5.3 5W

(Included Transformer)

BK **WH**



TRM-903

Spot light

HOUSING : ALUMINIUM

PAINTING : BLACK AND WHITE

780.-

COMPATIBLE BULB	
	MR16 / GX5.3 50W

LED REPLACEMENT	
	LED-MR16 / GX5.3 5W

(Included Transformer)

BK **WH**



TRL-903

Track light

HOUSING : ALUMINIUM

PAINTING : BLACK AND WHITE

780.-

COMPATIBLE BULB	
	MR16 / GX5.3 50W

LED REPLACEMENT	
	LED-MR16 / GX5.3 5W

(Included Transformer)

BK **WH**



TRM-QR043

Spot light

HOUSING : ALUMINIUM

PAINTING : BLACK AND WHITE

900.-

(รวมหลอด 50W)

COMPATIBLE BULB	
	QR111 50W

LED REPLACEMENT	
	LED-QR111 15W

(Included Transformer)

BK **WH**



TRL-QR043

Track light

HOUSING : ALUMINIUM

PAINTING : BLACK AND WHITE

900.-

(รวมหลอด 50W)

COMPATIBLE BULB	
	QR111 50W

LED REPLACEMENT	
	LED-QR111 15W

(Included Transformer)

BK **WH**



TRM-99

Spot light

HOUSING : ALUMINIUM

PAINTING : BLACK AND WHITE

300.-

COMPATIBLE BULB	
	PAR38 / E27 120W

LED REPLACEMENT	
	LED-PAR30 / E27 22W

(Included Transformer)

BK **WH**



TRL-99

Spot light

HOUSING : ALUMINIUM

PAINTING : BLACK AND WHITE

300.-

COMPATIBLE BULB	
	PAR38 / E27 120W

LED REPLACEMENT	
	LED-PAR30 / E27 22W

(Included Transformer)

BK **WH**



TRM-U30

Spot light

HOUSING : STEEL
PAINTING : WHITE, GREY AND BLACK

360.-



COMPATIBLE BULB	
	PAR30 / E27 100W

LED REPLACEMENT	
	LED-PAR30 / E27 15W



TRL-U30

Track light

HOUSING : STEEL
PAINTING : WHITE, GREY AND BLACK

360.-



COMPATIBLE BULB	
	PAR30 / E27 100W

LED REPLACEMENT	
	LED-PAR30 / E27 15W



TRM-U38

Spot light

HOUSING : STEEL
PAINTING : WHITE, GREY AND BLACK

380.-



COMPATIBLE BULB	
	PAR38 / E27 120W

LED Replacement	
	LED-PAR38 / E27 22W



TRL-U38

Track light

HOUSING : STEEL
PAINTING : WHITE, GREY AND BLACK

380.-



COMPATIBLE BULB	
	PAR38 / E27 120W

LED REPLACEMENT	
	LED-PAR38 / E27 22W



TR-1M

400.-/1M

HOUSING : ALUMINIUM
PAINTING : BLACK OR WHITE

TR-2M

800.-/2M

TR-3M

1,200.-/3M



TR-A1

HOUSING : ABS
PAINTING : BLACK OR WHITE

120.-



หัวจ่าย

TR-A2

HOUSING : ABS
PAINTING : BLACK OR WHITE



120.-



TR-A3

HOUSING : ABS
PAINTING : BLACK OR WHITE



140.-







TRM-400

Spot light

HOUSING : ALUMINIUM
PAINTING : BLACK AND WHITE

500.-

Compatible Bulb	
	PAR30 / E27 75W
LED Replacement	
	LED-PAR30 / E27 12W

BK **WH** (INCLUDED TRANSFORMER)





TRL-400

Spot light

HOUSING : ALUMINIUM
PAINTING : BLACK AND WHITE

500.-

Compatible Bulb	
	PAR30 / E27 75W
LED Replacement	
	LED-PAR30 / E27 12W

BK **WH** (INCLUDED TRANSFORMER)





TRL-Q300

Spot light

HOUSING : ALUMINIUM
PAINTING : BLACK AND WHITE

600.-

Compatible Bulb	
	QR111 / G53 50 / 75 / 100W (x1)
Led Replacement	
	LED-QR111 / G53 11W / 15W (x1)

BK **WH** (INCLUDED TRANSFORMER)





TRM-401

Spot light

HOUSING : ALUMINIUM
PAINTING : BLACK AND WHITE

550.-

Compatible Bulb	
	PAR30 / E27 75W
LED Replacement	
	LED-PAR30 / E27 12W

BK **WH** (INCLUDED TRANSFORMER)

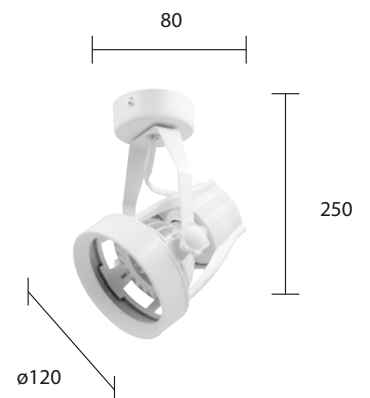

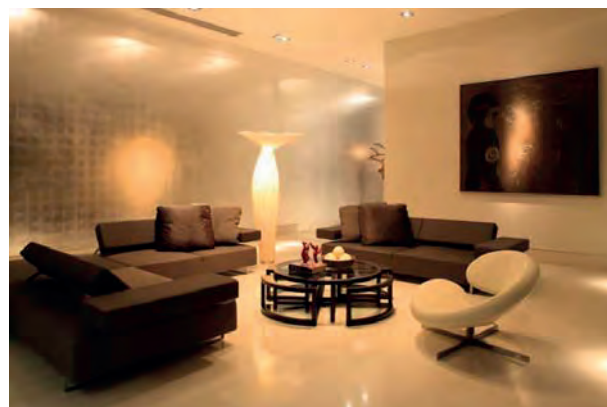

LEO-10311

1-Multiple Recessed Downlight

HOUSING : COLD-ROLL STEEL SHEET, COATED WITH POLYESTER POWDER

REFLECTOR : ALUMINIUM ANODIZED REFLECTOR

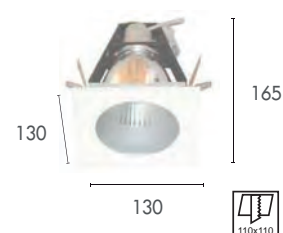

400.-

Compatible Bulb

	PLC/G24-D 13W (x1)		GENIE / E27 14W (x1)
-------------------------------------------------------------------------------------	-----------------------	-------------------------------------------------------------------------------------	-------------------------

LED Replacement

	LED-LA60 / E27 7W / 9W (x1)
---------------------------------------------------------------------------------------	--------------------------------



LEO-10312

2-Multiple Recessed Downlight

HOUSING : COLD-ROLL STEEL SHEET, COATED WITH POLYESTER POWDER

REFLECTOR : ALUMINIUM ANODIZED REFLECTOR



700.-

Compatible Bulb

	PLC/G24-D 13W (x2)		GENIE / E27 14W (x2)
-------------------------------------------------------------------------------------	-----------------------	-------------------------------------------------------------------------------------	-------------------------

LED Replacement

	LED-LA60 / E27 7W / 9W (x2)
---------------------------------------------------------------------------------------	--------------------------------



LEO-10313

3-Multiple Recessed Downlight

HOUSING : COLD-ROLL STEEL SHEET, COATED WITH POLYESTER POWDER

REFLECTOR : ALUMINIUM ANODIZED REFLECTOR



1,100.-

Compatible Bulb

	PLC/G24-D 13W (x3)		GENIE / E27 14W (x3)
-------------------------------------------------------------------------------------	-----------------------	-------------------------------------------------------------------------------------	-------------------------

LED Replacement

	LED-LA60 / E27 7W / 9W (x3)
---------------------------------------------------------------------------------------	--------------------------------

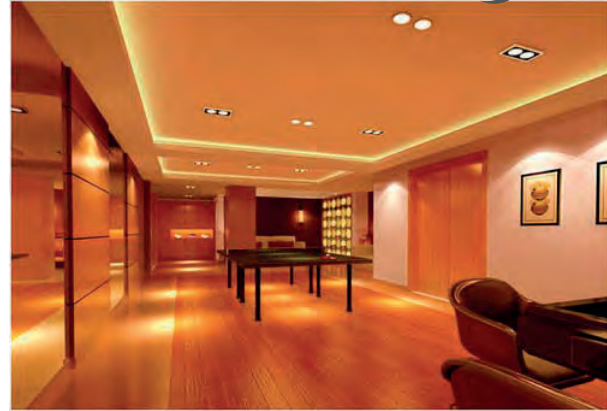

DL-412

1-Multiple Recessed Downlight

HOUSING : COLD-ROLL STEEL SHEET, COATED WITH POLYESTER POWDER

REFLECTOR : ALUMINIUM ANODIZED REFLECTOR

INSTALLATION : RECESSED MOUNTING

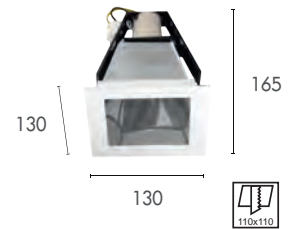

200.-

Compatible Bulb	
	PLC/G24-D 13W (x1)
	GENIE / E27 14W (x1)

LED Replacement	
	LED-LA60 / E27 7W / 9W (x1)

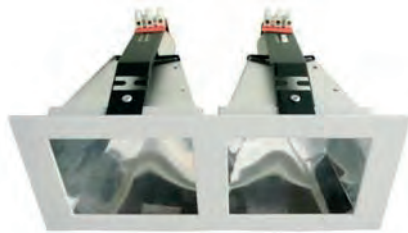

LEO-10412

2-Multiple Recessed Downlight



HOUSING : COLD-ROLL STEEL SHEET, COATED WITH POLYESTER POWDER

REFLECTOR : ALUMINIUM ANODIZED REFLECTOR

INSTALLATION : RECESSED MOUNTING



600.-

Compatible Bulb	
	PLC/G24-D 13W (x2)
	GENIE / E27 14W (x2)

LED Replacement	
	LED-LA60 / E27 7W / 9W (x2)



LEO-10413

3-Multiple Recessed Downlight



HOUSING : COLD-ROLL STEEL SHEET, COATED WITH POLYESTER POWDER

REFLECTOR : ALUMINIUM ANODIZED REFLECTOR

INSTALLATION : RECESSED MOUNTING



900.-

Compatible Bulb	
	PLC/G24-D 13W (x3)
	GENIE / E27 14W (x3)

LED Replacement	
	LED-LA60 / E27 7W / 9W (x3)



220.-

DL-441

Recessed Downlight

HOUSING : COLD-ROLL STEEL SHEET, COATED WITH POLYESTER POWDER

REFLECTOR : ALUMINIUM ANODIZED REFLECTOR

INSTALLATION : RECESSED MOUNTING

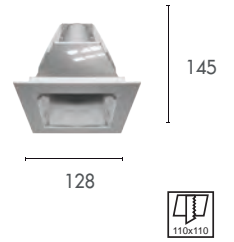

Compatible Bulb	
	GENIE / E27 11W (x1)

LED Replacement	
	LED-LA60 / E27 7W / 9W (x1)



450.-

LEO-11417

Recessed Downlight

HOUSING : COLD-ROLL STEEL SHEET, COATED WITH POLYESTER POWDER

REFLECTOR : ALUMINIUM ANODIZED REFLECTOR

INSTALLATION : RECESSED MOUNTING

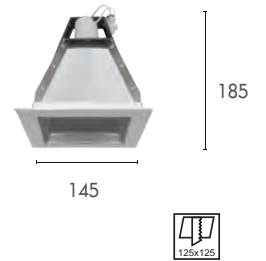

Compatible Bulb	
	PLC/G24-D 18W (x1)
	GENIE / E27 18W (x1)

LED Replacement	
	LED-LA70 / E27 12W / 14W (x1)



510.-

LEO-11418

Recessed Downlight

HOUSING : COLD-ROLL STEEL SHEET, COATED WITH POLYESTER POWDER

REFLECTOR : ALUMINIUM ANODIZED REFLECTOR

INSTALLATION : RECESSED MOUNTING

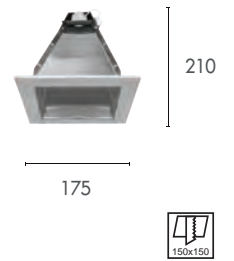

Compatible Bulb	
	PLC/G24-D 18W (x1)
	TORNADO / E27 24W (x1)

LED Replacement	
	LED-LA70 / E27 12W / 14W (x1)



480.-

LEO-11416/G

Recessed Downlight

HOUSING : COLD-ROLL STEEL SHEET, COATED WITH POLYESTER POWDER

REFLECTOR : ALUMINIUM ANODIZED REFLECTOR

INSTALLATION : RECESSED MOUNTING

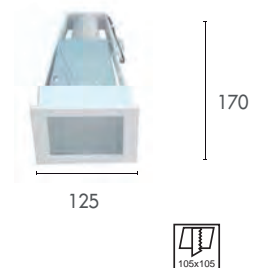

Compatible Bulb	
	PLC/G24-D 18W (x1)
	GENIE / E27 18W (x1)

LED Replacement	
	LED-LA70 / E27 12W / 14W (x1)



600.-

LEO-11511

1-Multiple Recessed Downlight

HOUSING : COLD-ROLL STEEL SHEET, COATED WITH POLYESTER POWDER

REFLECTOR : ALUMINIUM ANODIZED REFLECTOR

INSTALLATION : RECESSED T-BAR OR GYPSUM MOUNTING

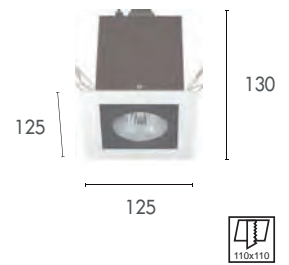

Compatible Bulb	
	GU10 220V 50W (x1)

LED Replacement	
	LED-GU10 220V 5.5W (x1)
	LED-LA60 / E27 7W / 9W (x1)



1,200.-

LEO-11512

2-Multiple Recessed Downlight

HOUSING : COLD-ROLL STEEL SHEET, COATED WITH POLYESTER POWDER

REFLECTOR : ALUMINIUM ANODIZED REFLECTOR

INSTALLATION : RECESSED T-BAR OR GYPSUM MOUNTING

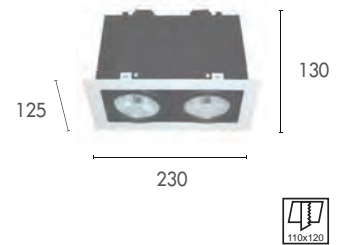

Compatible Bulb	
	GU10 220V 50W (x2)

LED Replacement	
	LED-GU10 220V 5.5W (x2)
	LED-LA60 / E27 7W / 9W (x2)



700.-

LEO-11611

1-Multiple Recessed Downlight

HOUSING : COLD-ROLL STEEL SHEET, COATED WITH POLYESTER POWDER

REFLECTOR : ALUMINIUM ANODIZED REFLECTOR

INSTALLATION : RECESSED T-BAR OR GYPSUM MOUNTING

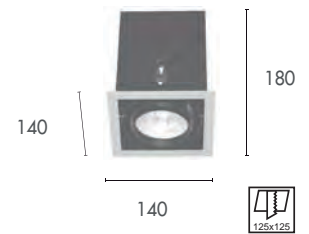

Compatible Bulb	
	TORNADO / E27 15W (x1)

LED Replacement	
	LED-LA60 / E27 7W / 9W (x1)



1,400.-

LEO-11612

2 -Multiple Recessed Downlight

HOUSING : COLD-ROLL STEEL SHEET, COATED WITH POLYESTER POWDER

REFLECTOR : ALUMINIUM ANODIZED REFLECTOR

INSTALLATION : RECESSED T-BAR OR GYPSUM MOUNTING



Compatible Bulb	
	TORNADO / E27 15W (x2)

LED Replacement	
	LED-LA60 / E27 7W / 9W (x2)



950.-

LEO-11711

1-Multiple Recessed Downlight

HOUSING : COLD-ROLL STEEL SHEET, COATED WITH POLYESTER POWDER

REFLECTOR : ALUMINIUM ANODIZED REFLECTOR

INSTALLATION : RECESSED T-BAR OR GYPSUM MOUNTING

Compatible Bulb	
	TORNADO / E27 24W (x1)

LED Replacement	
	LED-LA70 / E27 12W / 14W (x1)

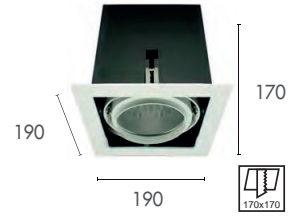

1,800.-

LEO-11712

2-Multiple Recessed Downlight

HOUSING : COLD-ROLL STEEL SHEET, COATED WITH POLYESTER POWDER

REFLECTOR : ALUMINIUM ANODIZED REFLECTOR

INSTALLATION : RECESSED T-BAR OR GYPSUM MOUNTING

Compatible Bulb	
	TORNADO / E27 24W (x2)

LED Replacement	
	LED-LA70 / E27 12W / 14W (x2)

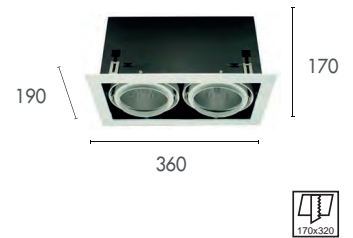

1,200.-

DL-P400-1

1-multiple Recessed downlight

HOUSING : COLD-ROLL STEEL SHEET, COATED WITH POLYESTER POWDER

INSTALLATION : RECESSED T-BAR OR GYPSUM MOUNTING

LED Replacement			
	LED-PAR30 / E27 12W / 15W		LED-LA70 / E27 12W / 14W (x1)



2,400.-

DL-P400-2

2-Multiple Recessed Downlight

HOUSING : COLD-ROLL STEEL SHEET, COATED WITH POLYESTER POWDER

INSTALLATION : RECESSED T-BAR OR GYPSUM MOUNTING

LED Replacement			
	LED-PAR30 / E27 12W / 15W		LED-LA70 / E27 12W / 14W (x1)





400.-



LEO-10611

1-Multiple Recessed Downlight

HOUSING : COLD-ROLL STEEL SHEET, COATED WITH POLYESTER POWDER

REFLECTOR : ALUMINIUM ANODIZED REFLECTOR

INSTALLATION : RECESSED T-BAR OR GYPSUM MOUNTING

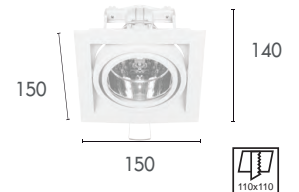

Compatible Bulb



LED Replacement



460.-



LEO-10661

1-Multiple Recessed Downlight

HOUSING : COLD-ROLL STEEL SHEET, COATED WITH POLYESTER POWDER

REFLECTOR : ALUMINIUM ANODIZED REFLECTOR

INSTALLATION : RECESSED T-BAR OR GYPSUM MOUNTING

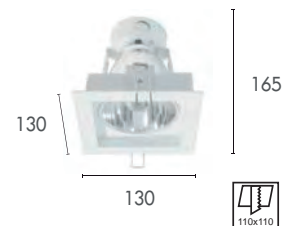

Compatible Bulb



LED Replacement



920.-



LEO-10662

2-Multiple Recessed Downlight

HOUSING : COLD-ROLL STEEL SHEET, COATED WITH POLYESTER POWDER

REFLECTOR : ALUMINIUM ANODIZED REFLECTOR

INSTALLATION : RECESSED T-BAR OR GYPSUM MOUNTING

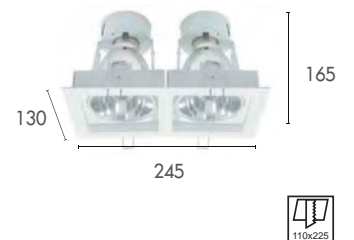

Compatible Bulb



LED Replacement



1,380.-



LEO-10663

3-Multiple Recessed Downlight

HOUSING : COLD-ROLL STEEL SHEET, COATED WITH POLYESTER POWDER

REFLECTOR : ALUMINIUM ANODIZED REFLECTOR

INSTALLATION : RECESSED T-BAR OR GYPSUM MOUNTING



Compatible Bulb



LED Replacement





450.-

LEO-H150/S

Recessed Downlight

HOUSING : COLD-ROLL STEEL SHEET, COATED WITH POLYESTER POWDER

REFLECTOR : ALUMINIUM ANODIZED REFLECTOR

INSTALLATION : RECESSED T-BAR OR GYPSUM MOUNTING



152

170

130x130

Compatible Bulb	
	GENIE / E27 14W (x1)

LED Replacement	
	LED-LA60 / E27 7W / 9W (x1)



450.-

LEO-H150/SN

Recessed Downlight

HOUSING : COLD-ROLL STEEL SHEET, COATED WITH POLYESTER POWDER

REFLECTOR : ALUMINIUM ANODIZED REFLECTOR

INSTALLATION : RECESSED T-BAR OR GYPSUM MOUNTING

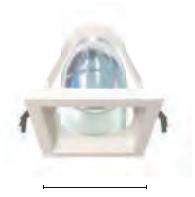

152

170

130x130

Compatible Bulb	
	GENIE / E27 14W (x1)

LED Replacement	
	LED-LA60 / E27 7W / 9W (x1)



450.-

LEO-J150/S

Recessed Downlight

HOUSING : COLD-ROLL STEEL SHEET, COATED WITH POLYESTER POWDER

REFLECTOR : ALUMINIUM ANODIZED REFLECTOR

INSTALLATION : RECESSED T-BAR OR GYPSUM MOUNTING

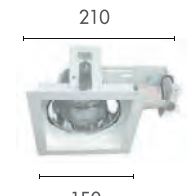

150

210

100



Compatible Bulb	
	PLC/G24-D 13W (x1)

Compatible Bulb	
	GENIE / E27 14W (x1)

LED Replacement	
	LED-PLE / E27 7W (x1)



450.-

LEO-J150/SN

Recessed Downlight

HOUSING : COLD-ROLL STEEL SHEET, COATED WITH POLYESTER POWDER

REFLECTOR : ALUMINIUM ANODIZED REFLECTOR

INSTALLATION : RECESSED T-BAR OR GYPSUM MOUNTING

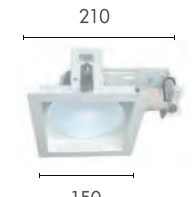

150

210

100



Compatible Bulb	
	PLC/G24-D 13W (x1)

Compatible Bulb	
	GENIE / E27 14W (x1)

LED Replacement	
	LED-PLE / E27 7W (x1)



300.-

LEO-11416N

Recessed Downlight

HOUSING : COLD-ROLL STEEL SHEET, COATED WITH POLYESTER POWDER

REFLECTOR : ALUMINIUM ANODIZED REFLECTOR

INSTALLATION : RECESSED T-BAR OR GYPSUM MOUNTING

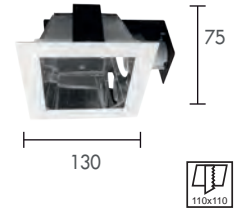

Compatible Bulb	
	GENIE / E27 14W (x1)

LED Replacement	
	LED-LA60 / E27 7W / 9W (x1)
	LED-PLE / E27 7W (x1)



500.-

LEO-11418N

Recessed Downlight

HOUSING : COLD-ROLL STEEL SHEET, COATED WITH POLYESTER POWDER

REFLECTOR : ALUMINIUM ANODIZED REFLECTOR

INSTALLATION : RECESSED T-BAR OR GYPSUM MOUNTING

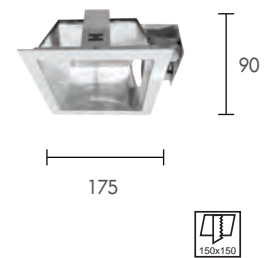

Compatible Bulb	
	GENIE / E27 18W (x2)

LED Replacement	
	LED-LA60 / E27 7W / 9W (x2)
	LED-PLE / E27 10W (x2)

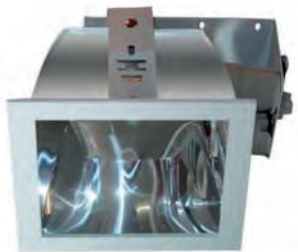

800.-

LEO-12418-1

Recessed Downlight

HOUSING : COLD-ROLL STEEL SHEET, COATED WITH POLYESTER POWDER

REFLECTOR : ALUMINIUM ANODIZED REFLECTOR

INSTALLATION : RECESSED T-BAR OR GYPSUM MOUNTING

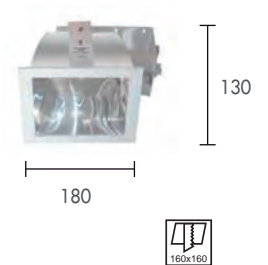

Compatible Bulb	
	GENIE / E27 18W (x2)

LED Replacement	
	LED-LA60 / E27 7W / 9W (x2)
	LED-PLE / E27 10W (x2)



360.-

LEO-12609

Recessed Downlight

HOUSING : COLD-ROLL STEEL SHEET, COATED WITH POLYESTER POWDER

REFLECTOR : ALUMINIUM ANODIZED REFLECTOR

INSTALLATION : RECESSED T-BAR OR GYPSUM MOUNTING

DIFFUSER : FROST GLASS



Compatible Bulb	
	GENIE / E27 11W (x1)



360.-

LEO-12611

Recessed Downlight

HOUSING : COLD-ROLL STEEL SHEET, COATED WITH POLYESTER POWDER

REFLECTOR : ALUMINIUM ANODIZED REFLECTOR

INSTALLATION : RECESSED T-BAR OR GYPSUM MOUNTING

DIFFUSER : FROST GLASS

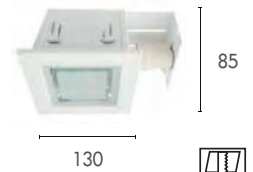

Compatible Bulb		LED Replacement	
	GENIE / E27 11W (x1)		LED-LA60 / E27 7W / 9W (x1)
			LED-PLE / E27 7W (x1)



550.-

LEO-12613

Recessed Downlight

HOUSING : COLD-ROLL STEEL SHEET, COATED WITH POLYESTER POWDER

REFLECTOR : ALUMINIUM ANODIZED REFLECTOR

INSTALLATION : RECESSED T-BAR OR GYPSUM MOUNTING

DIFFUSER : FROST GLASS

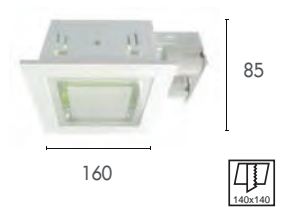

Compatible Bulb		LED Replacement	
	PLC/G24-D 18W (x2)		GENIE / E27 18W (x2)
			LED-PLE / E27 10W (x2)



750.-

LEO-12615

Recessed Downlight

HOUSING : COLD-ROLL STEEL SHEET, COATED WITH POLYESTER POWDER

REFLECTOR : ALUMINIUM ANODIZED REFLECTOR

INSTALLATION : RECESSED T-BAR OR GYPSUM MOUNTING

DIFFUSER : FROST GLASS

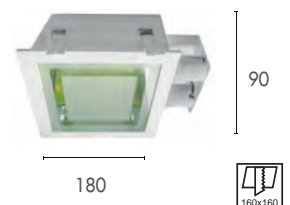

Compatible Bulb		LED Replacement	
	PLC/G24-D 18W (x2)		GENIE / E27 18W (x2)
			LED-PLE / E27 10W (x2)



360.-

LEO-12610

Recessed Downlight

HOUSING : COLD-ROLL STEEL SHEET, COATED WITH POLYESTER POWDER

REFLECTOR : ALUMINIUM ANODIZED REFLECTOR

INSTALLATION : RECESSED T-BAR OR GYPSUM MOUNTING

DIFFUSER : FROST GLASS

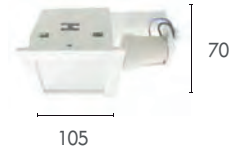

Compatible Bulb



360.-

LEO-12612

Recessed Downlight

HOUSING : COLD-ROLL STEEL SHEET, COATED WITH POLYESTER POWDER

REFLECTOR : ALUMINIUM ANODIZED REFLECTOR

INSTALLATION : RECESSED T-BAR OR GYPSUM MOUNTING

DIFFUSER : FROST GLASS



Compatible Bulb



LED Replacement



550.-

LEO-12614

Recessed Downlight

HOUSING : COLD-ROLL STEEL SHEET, COATED WITH POLYESTER POWDER

REFLECTOR : ALUMINIUM ANODIZED REFLECTOR

INSTALLATION : RECESSED T-BAR OR GYPSUM MOUNTING

DIFFUSER : FROST GLASS

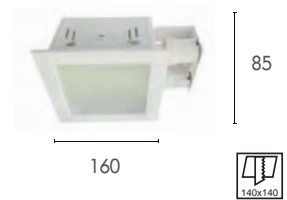

Compatible Bulb



LED Replacement



750.-

LEO-12616

Recessed Downlight

HOUSING : COLD-ROLL STEEL SHEET, COATED WITH POLYESTER POWDER

REFLECTOR : ALUMINIUM ANODIZED REFLECTOR

INSTALLATION : RECESSED T-BAR OR GYPSUM MOUNTING

DIFFUSER : FROST GLASS

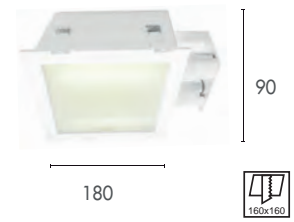

Compatible Bulb



LED Replacement





520.-

LEO-12627

Recessed Downlight

HOUSING : COLD-ROLL STEEL SHEET, COATED WITH POLYESTER POWDER

REFLECTOR : ALUMINIUM ANODIZED REFLECTOR

INSTALLATION : RECESSED MOUNTING

SUITABLE FOR SHOP, HOTEL, SHOWROOM, STORE DECORATION

DIFFUSER : FROST GLASS



140

80



Compatible Bulb



LED Replacement



680.-

LEO-12628

Recessed Downlight

HOUSING : COLD-ROLL STEEL SHEET, COATED WITH POLYESTER POWDER

REFLECTOR : ALUMINIUM ANODIZED REFLECTOR

INSTALLATION : RECESSED T-BAR OR GYPSUM MOUNTING

SUITABLE FOR SHOP, HOTEL, SHOWROOM, STORE DECORATION

DIFFUSER : FROST GLASS



172

90



Compatible Bulb



LED Replacement

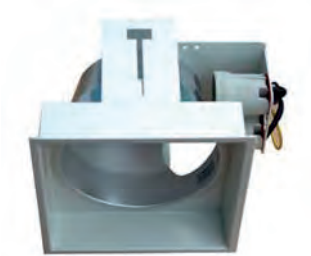

550.-

LEO-J165

Recessed Downlight

HOUSING : COLD-ROLL STEEL SHEET, COATED WITH POLYESTER POWDER

REFLECTOR : ALUMINIUM ANODIZED REFLECTOR

INSTALLATION : RECESSED MOUNTING

SUITABLE FOR SHOP, HOTEL, SHOWROOM, STORE DECORATION

DIFFUSER : FROST GLASS



165

116



Compatible Bulb



LED Replacement



750.-

LEO-J165/G

Recessed Downlight

HOUSING : COLD-ROLL STEEL SHEET, COATED WITH POLYESTER POWDER

REFLECTOR : ALUMINIUM ANODIZED REFLECTOR

INSTALLATION : RECESSED MOUNTING

SUITABLE FOR SHOP, HOTEL, SHOWROOM, STORE DECORATION

DIFFUSER : FROST GLASS



165

116



Compatible Bulb



LED Replacement





720.-

LEO-12644

Recessed Downlight

HOUSING : COLD-ROLL STEEL SHEET, COATED WITH POLYESTER POWDER

REFLECTOR : ALUMINIUM ANODIZED REFLECTOR

DIFFUSER : FROST GLASS



70

160



Compatible Bulb



PLC/G24-D
18W (x2)



GENIE / E27
18W (x2)

LED Replacement



LED-PLC / E27
10W (x2)



LEO-12644F



980.-

LEO-12645

Recessed Downlight

HOUSING : COLD-ROLL STEEL SHEET, COATED WITH POLYESTER POWDER

REFLECTOR : ALUMINIUM ANODIZED REFLECTOR

DIFFUSER : FROST GLASS



80

200



Compatible Bulb



PLC/G24-D
18W (x2)



GENIE / E27
18W (x2)

LED Replacement



LED-PLC / E27
10W (x2)



LEO-12645F



900.-

LEO-12418-2

Recessed Downlight

HOUSING : COLD-ROLL STEEL SHEET, COATED WITH POLYESTER POWDER

REFLECTOR : ALUMINIUM ANODIZED REFLECTOR

DIFFUSER : FROST GLASS



125

180



Compatible Bulb



GENIE / E27
11W (x2)

LED Replacement



LED-LA60 / E27
7W / 9W (x2)



LED-PLC / E27
7W (x2)

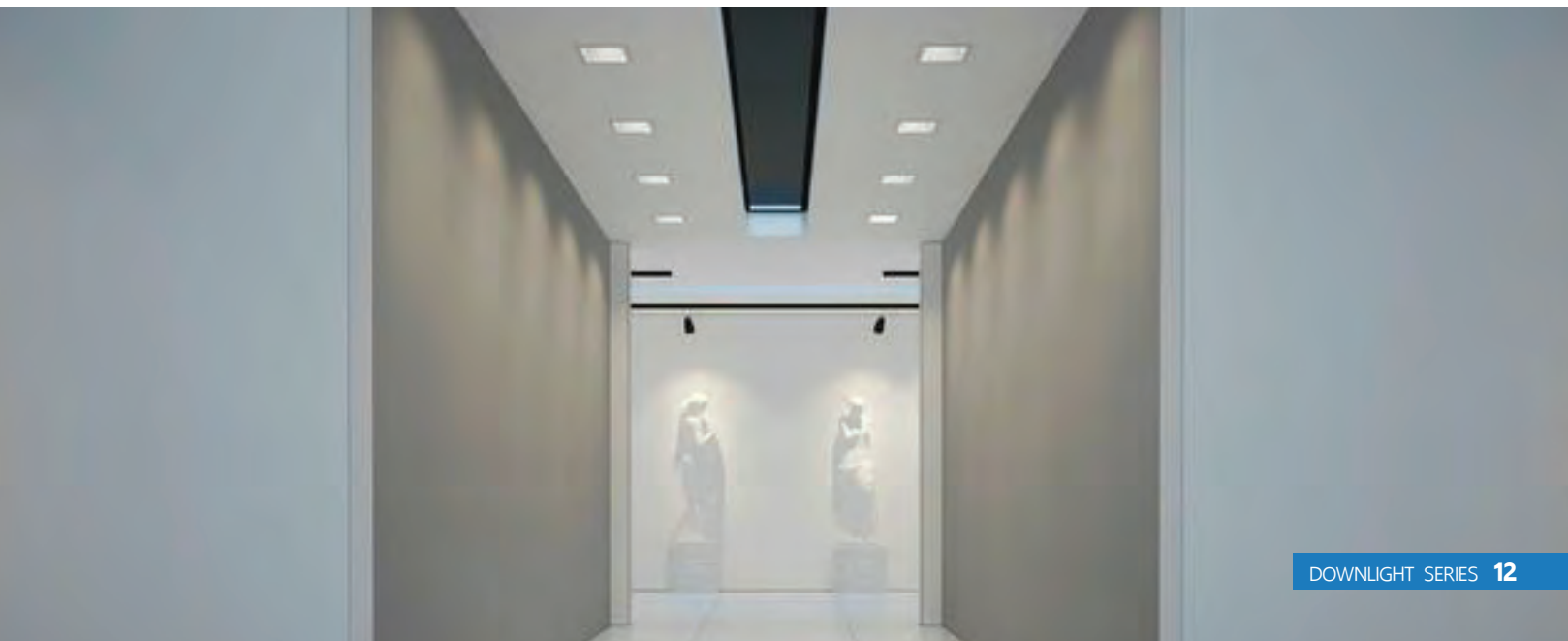



700.-

DLN-604-5

Recessed Downlight

HOUSING : COLD-ROLL STEEL SHEET, COATED WITH POLYESTER POWDER

REFLECTOR : ALUMINIUM ANODIZED REFLECTOR

DIFFUSER : GLASS



108

195



Compatible Bulb



PLC/G24-D
18W (x2)



GENIE / E27
18W (x2)

LED Replacement



LED-PLC / E27
10W (x2)



850.-

DLN-604-8

Recessed Downlight

HOUSING : COLD-ROLL STEEL SHEET, COATED WITH POLYESTER POWDER

REFLECTOR : ALUMINIUM ANODIZED REFLECTOR

DIFFUSER : GLASS



115

230



Compatible Bulb



PLC/G24-D
18W (x2)



GENIE / E27
18W (x2)

LED Replacement



LED-PLC / E27
10W (x2)



450.-

LEO-12612/ST

Recessed Downlight

HOUSING : COLD-ROLL STEEL SHEET, COATED WITH POLYESTER POWDER

REFLECTOR : ALUMINIUM ANODIZED REFLECTOR

DIFFUSER : FROST GLASS



85

130



Compatible Bulb



GENIE / E27
11W (x1)

LED Replacement



LED-LA60 / E27
7W / 9W (x1)



LED-PLC / E27
7W (x1)

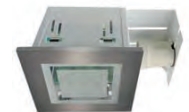

LEO-12611/ST STAINLESS TRIM

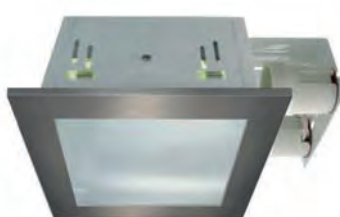

600.-

LEO-12614/ST

Recessed Downlight

HOUSING : COLD-ROLL STEEL SHEET, COATED WITH POLYESTER POWDER

REFLECTOR : ALUMINIUM ANODIZED REFLECTOR

DIFFUSER : FROST GLASS



85

160



Compatible Bulb



PLC/G24-D
18W (x2)



GENIE / E27
18W (x2)

LED Replacement



LED-PLC / E27
10W (x2)

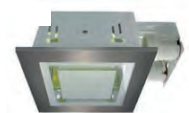

LEO-12613/ST STAINLESS TRIM

สำหรับฝ้าเพดาน



70.-

DL-L141/S

Recessed Downlight

HOUSING : COLD-ROLL STEEL SHEET, COATED WITH POLYESTER POWDER

REFLECTOR : ALUMINIUM ANODIZED REFLECTOR



NEW

LED Replacement			
	LED-LA60 / E27 7W / 9W (x1)		LED-LA70 / E27 12W / 14W (x1)

สำหรับฝ้าเพดาน



70.-

DL-L141/SN

Recessed Downlight

HOUSING : COLD-ROLL STEEL SHEET, COATED WITH POLYESTER POWDER

REFLECTOR : ALUMINIUM ANODIZED REFLECTOR



NEW

LED Replacement			
	LED-LA60 / E27 7W / 9W (x1)		LED-LA70 / E27 12W / 14W (x1)

สำหรับฝ้าเพดาน



110.-

DL-L171/S

Recessed Downlight

HOUSING : COLD-ROLL STEEL SHEET, COATED WITH POLYESTER POWDER

REFLECTOR : ALUMINIUM ANODIZED REFLECTOR



NEW

LED Replacement			
	LED-LA60 / E27 7W / 9W (x1)		LED-LA70 / E27 12W / 14W (x1)

สำหรับฝ้าเพดาน



110.-

DL-L171/SN

Recessed Downlight

HOUSING : COLD-ROLL STEEL SHEET, COATED WITH POLYESTER POWDER

REFLECTOR : ALUMINIUM ANODIZED REFLECTOR



NEW

LED Replacement			
	LED-LA60 / E27 7W / 9W (x1)		LED-LA70 / E27 12W / 14W (x1)



70.-

DL-121/3/A

Recessed Downlight

HOUSING : COLD-ROLL STEEL SHEET, COATED WITH POLYESTER POWDER

REFLECTOR : ALUMINIUM ANODIZED REFLECTOR



100

Ø120



Compatible Bulb



GENIE / E27
11W (x1)

LED Replacement



LED-LA60 / E27
7W / 9W (x1)



70.-

DL-141/3/A

Recessed Downlight

HOUSING : COLD-ROLL STEEL SHEET, COATED WITH POLYESTER POWDER

REFLECTOR : ALUMINIUM ANODIZED REFLECTOR



160

Ø143



C 90.-



SA 100.-



S 100.-



SN 90.-

Compatible Bulb



PLC/G24-D
13W (x1)



GENIE / E27
14W (x1)

LED Replacement



LED-LA60 / E27
7W / 9W (x1)



120.-

DL-171/3/A

Recessed Downlight

HOUSING : COLD-ROLL STEEL SHEET, COATED WITH POLYESTER POWDER

REFLECTOR : ALUMINIUM ANODIZED REFLECTOR



190

Ø177



C 140.-



SA 150.-



S 150.-



SN 140.-

Compatible Bulb



PLC/G24-D
13W (x1)



TORNADO / E27
24W (x1)

LED Replacement



LED-LA70 / E27
12W / 14W (x1)



150.-

DL-141/3Q/SA

Recessed Downlight

HOUSING : COLD-ROLL STEEL SHEET, COATED WITH POLYESTER POWDER

REFLECTOR : ALUMINIUM ANODIZED REFLECTOR



280

Ø145



Compatible Bulb



LED Replacement



190.-

DL-171/3Q/SA

Recessed Downlight

HOUSING : COLD-ROLL STEEL SHEET, COATED WITH POLYESTER POWDER

REFLECTOR : ALUMINIUM ANODIZED REFLECTOR



235

Ø180



Compatible Bulb



LED Replacement

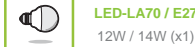

430.-

DL-201/2/A

Recessed Downlight

HOUSING : COLD-ROLL STEEL SHEET, COATED WITH POLYESTER POWDER

REFLECTOR : ALUMINIUM ANODIZED REFLECTOR

INSTALLATION : RECESSED MOUNTING



S



SN



220

Ø200



Compatible Bulb



LED Replacement



480.-

DL-221/2/A

Recessed Downlight

HOUSING : COLD-ROLL STEEL SHEET, COATED WITH POLYESTER POWDER

REFLECTOR : ALUMINIUM ANODIZED REFLECTOR



S



SN



230

Ø220



Compatible Bulb



LED Replacement





900.-

DL-251/2/SN

Recessed Round Downlight

HOUSING : COLD-ROLL STEEL SHEET, COATED WITH POLYESTER POWDER

REFLECTOR : ALUMINIUM ANODIZED REFLECTOR



DL-251/2/S



210

Ø250



Compatible Bulb	
	MH / E27 70W / 150W (x1)

LED Replacement	
	LED-LA70 / E27 12W / 14W (x1)



900.-

DL-M3/P38

Recessed Downlight

HOUSING : COLD-ROLL STEEL SHEET, COATED WITH POLYESTER POWDER

REFLECTOR : ALUMINIUM ANODIZED REFLECTOR



235

Ø180



Compatible Bulb	
	PAR38 / E27 80W / 120W (x1)

LED Replacement	
	LED-PAR38 / E27 15W (x1)



850.-

DL-M4/P30

Recessed Downlight

HOUSING : COLD-ROLL STEEL SHEET, COATED WITH POLYESTER POWDER

REFLECTOR : ALUMINIUM ANODIZED REFLECTOR



220

Ø200



Compatible Bulb	
	PAR30 / E27 75W (x1)

LED Replacement	
	LED-PAR30 / E27 12W / 15W (x1)



1.550.-

DL-M5

Recessed Downlight

HOUSING : COLD-ROLL STEEL SHEET, COATED WITH POLYESTER POWDER

REFLECTOR : ALUMINIUM ANODIZED REFLECTOR



85

Ø160



Compatible Bulb	
	PAR56 300W (x1)

LED Replacement	
	LED-PAR56 30W (x1)



DL-171/3/G

Recessed Downlight

HOUSING : COLD-ROLL STEEL SHEET, COATED WITH POLYESTER POWDER

REFLECTOR : ALUMINIUM ANODIZED REFLECTOR

DIFFUSER : GLASS



195

Ø175



280.-

Compatible Bulb



PLC/G24-D
18W (x1)



TORNADO / E27
24W (x1)

LED Replacement



LED-LA70 / E27
12W / 14W (x1)



DL-171/3/G-1

Recessed Downlight

HOUSING : COLD-ROLL STEEL SHEET, COATED WITH POLYESTER POWDER

REFLECTOR : ALUMINIUM ANODIZED REFLECTOR

DIFFUSER : GLASS



190

Ø175



280.-

Compatible Bulb



PLC/G24-D
18W (x1)



TORNADO / E27
24W (x1)

LED Replacement



LED-LA70 / E27
12W / 14W (x1)



180.-

DLN-141/A

Recessed Downlight

HOUSING : COLD-ROLL STEEL SHEET, COATED WITH POLYESTER POWDER

REFLECTOR : ALUMINIUM ANODIZED REFLECTOR



DLN-141/S

DLN-141/SN

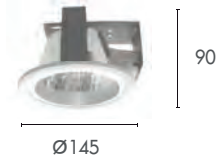

Compatible Bulb	
	PLC/G24-D 13W (x1)
	GENIE / E27 14W (x1)

LED Replacement	
	LED-LA60 / E27 7W / 9W (x1)
	LED-PL / E27 7W (x1)



220.-

DLN-171/A

Recessed Downlight

HOUSING : COLD-ROLL STEEL SHEET, COATED WITH POLYESTER POWDER

REFLECTOR : ALUMINIUM ANODIZED REFLECTOR



DLN-171/S

DLN-171/SN



Compatible Bulb	
	PLC/G24-D 13W (x1)
	GENIE / E27 18W (x1)

LED Replacement	
	LED-LA60 / E27 7W / 9W (x1)
	LED-PL / E27 7W (x1)



300.-

DLN-191/A

Recessed Downlight

HOUSING : COLD-ROLL STEEL SHEET, COATED WITH POLYESTER POWDER

REFLECTOR : ALUMINIUM ANODIZED REFLECTOR

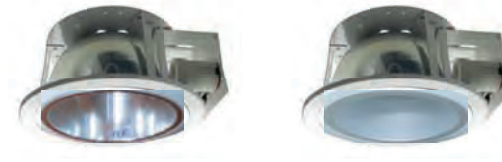

DLN-191/S

DLN-191/SN

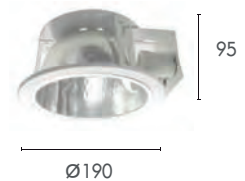

Compatible Bulb	
	PLC/G24-D 13W (x2)
	GENIE / E27 18W (x2)

LED Replacement	
	LED-LA70 / E27 12W / 14W (x2)
	LED-PL / E27 10W (x2)



600.-

DLN-2805-A

Recessed Downlight

HOUSING : COLD-ROLL STEEL SHEET, COATED WITH POLYESTER POWDER

REFLECTOR : ALUMINIUM ANODIZED REFLECTOR



125

Ø220



Compatible Bulb

	PLC/G24-D 26W (x2)		GENIE / E27 18W (x2)
-----------------------------------------------------------------------------------	-----------------------	-----------------------------------------------------------------------------------	-------------------------

LED Replacement

	LED-PLC / E27 10W (x2)
-------------------------------------------------------------------------------------	---------------------------



800.-

DLN-2805-B

Recessed Downlight

HOUSING : COLD-ROLL STEEL SHEET, COATED WITH POLYESTER POWDER

REFLECTOR : ALUMINIUM ANODIZED REFLECTOR



125

Ø220



Compatible Bulb

	PLC/G24-D 26W (x2)		GENIE / E27 18W (x2)
-------------------------------------------------------------------------------------	-----------------------	-------------------------------------------------------------------------------------	-------------------------

LED Replacement

	LED-PLC / E27 10W (x2)
---------------------------------------------------------------------------------------	---------------------------



580.-

DLN-221/S

Recessed Downlight

HOUSING : COLD-ROLL STEEL SHEET, COATED WITH POLYESTER POWDER

REFLECTOR : ALUMINIUM ANODIZED REFLECTOR



120

Ø220



DLN-221/SN



Compatible Bulb

	PLC/G24-D 26W (x2)		GENIE / E27 18W (x2)
-------------------------------------------------------------------------------------	-----------------------	-------------------------------------------------------------------------------------	-------------------------

LED Replacement

	LED-PLC / E27 10W (x2)
---------------------------------------------------------------------------------------	---------------------------



960.-

DLN-251/S

Recessed Downlight

HOUSING : COLD-ROLL STEEL SHEET, COATED WITH POLYESTER POWDER

REFLECTOR : ALUMINIUM ANODIZED REFLECTOR



170

Ø250



DLN-251/SN



Compatible Bulb

	PLC/G24-D 26W (x2)		TORNADO / E27 24W (x2)
-------------------------------------------------------------------------------------	-----------------------	-------------------------------------------------------------------------------------	---------------------------

LED Replacement

	LED-PLC / E27 10W (x2)
---------------------------------------------------------------------------------------	---------------------------



DLN-2701

Recessed Downlight

HOUSING : COLD-ROLL STEEL SHEET, COATED WITH POLYESTER POWDER

REFLECTOR : ALUMINIUM ANODIZED REFLECTOR



125

Ø220



900.-

Compatible Bulb

	PLC/G24-D 13W (x2)		GENIE / E27 14W (x2)
--	-----------------------	--	-------------------------

LED Replacement

	LED-PLC / E27 10W (x2)
--	---------------------------



DLN-S230

Recessed Downlight

HOUSING : COLD-ROLL STEEL SHEET, COATED WITH POLYESTER POWDER

REFLECTOR : ALUMINIUM ANODIZED REFLECTOR



120

Ø220



950.-

Compatible Bulb

	PLC/G24-D 13W (x2)		GENIE / E27 14W (x2)
--	-----------------------	--	-------------------------

LED Replacement

	LED-PLC / E27 10W (x2)
--	---------------------------

สำหรับฝ้าเพดาน



DLN-2600

Recessed Downlight

HOUSING : COLD-ROLL STEEL SHEET, COATED WITH POLYESTER POWDER

REFLECTOR : ALUMINIUM ANODIZED REFLECTOR



70

Ø174



320.-

Compatible Bulb

	PLC/G24-D 13W (x1)		GENIE / E27 14W (x1)
--	-----------------------	--	-------------------------

LED Replacement

	LED-PLC / E27 10W (x1)
--	---------------------------



DLN-141/G

Recessed Horizontal Downlight

HOUSING : COLD-ROLL STEEL SHEET, COATED WITH POLYESTER POWDER

REFLECTOR : ALUMINIUM ANODIZED REFLECTOR

DIFFUSER : GLASS



240.-

Compatible Bulb	
	GENIE / E27 14W (x1)



DLN-171/G

Recessed Horizontal Downlight

HOUSING : COLD-ROLL STEEL SHEET, COATED WITH POLYESTER POWDER

REFLECTOR : ALUMINIUM ANODIZED REFLECTOR

DIFFUSER : GLASS

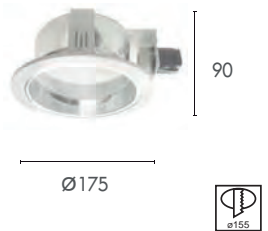

300.-

Compatible Bulb	
	GENIE / E27 14W (x1)



DLN-181/G

Recessed Horizontal Downlight

HOUSING : COLD-ROLL STEEL SHEET, COATED WITH POLYESTER POWDER

REFLECTOR : ALUMINIUM ANODIZED REFLECTOR

DIFFUSER : GLASS

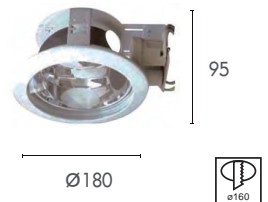

440.-

Compatible Bulb		Compatible Bulb	
	PLC/G24-D 13W (x2)		GENIE / E27 14W (x2)



DLN-191/G

Recessed Horizontal Downlight

HOUSING : COLD-ROLL STEEL SHEET, COATED WITH POLYESTER POWDER

REFLECTOR : ALUMINIUM ANODIZED REFLECTOR

DIFFUSER : GLASS



480.-

Compatible Bulb		Compatible Bulb	
	PLC/G24-D 13W (x2)		GENIE / E27 14W (x2)



240.-

DLN-141/G-1

Recessed Downlight

HOUSING : COLD-ROLL STEEL SHEET, COATED WITH POLYESTER POWDER

REFLECTOR : ALUMINIUM ANODIZED REFLECTOR

DIFFUSER : GLASS



Ø140

85



Compatible Bulb



LED Replacement



340.-

DLN-171/G-1

Recessed Downlight

HOUSING : COLD-ROLL STEEL SHEET, COATED WITH POLYESTER POWDER

REFLECTOR : ALUMINIUM ANODIZED REFLECTOR

DIFFUSER : GLASS



Ø170

100



Compatible Bulb



LED Replacement



480.-

DLN-191/G-1

Recessed Downlight

HOUSING : COLD-ROLL STEEL SHEET, COATED WITH POLYESTER POWDER

REFLECTOR : ALUMINIUM ANODIZED REFLECTOR

DIFFUSER : GLASS



Ø195

100



Compatible Bulb



Compatible Bulb



LED Replacement



780.-

DLN-231/G-1

Recessed Downlight

HOUSING : COLD-ROLL STEEL SHEET, COATED WITH POLYESTER POWDER

REFLECTOR : ALUMINIUM ANODIZED REFLECTOR

DIFFUSER : GLASS



Ø230

125



Compatible Bulb



Compatible Bulb



LED Replacement





950.-



LEO-23111/P30

1-multiple Recessed downlight

HOUSING : COLD-ROLL STEEL SHEET, COATED WITH POLYESTER POWDER

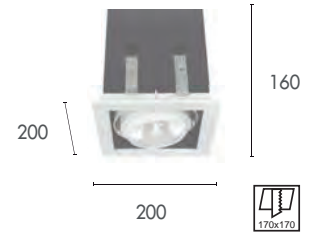

Compatible Bulb	
	PAR30 / E27 75W

LED Replacement	
	LED-PAR30 / E27 12W / 15W



1,800.-



LEO-23112/P30

2-Multiple Recessed Downlight

HOUSING : COLD-ROLL STEEL SHEET, COATED WITH POLYESTER POWDER



Compatible Bulb	
	PAR30 / E27 75W (x2)

LED Replacement	
	LED-PAR30 / E27 12W / 15W (x2)



950.-



LEO-23301/G12

1-Multiple Recessed Downlight

HOUSING : COLD-ROLL STEEL SHEET, COATED WITH POLYESTER POWDER

REFLECTOR : ALUMINIUM ANODIZED REFLECTOR

DIFFUSER : GLASS

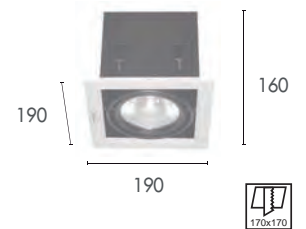

Compatible Bulb	
	CDM-T / G12 35W / 70W / 150W (x1)



1,800.-



LEO-23302/G12

2-Multiple Recessed Downlight

HOUSING : COLD-ROLL STEEL SHEET, COATED WITH POLYESTER POWDER

REFLECTOR : ALUMINIUM ANODIZED REFLECTOR

DIFFUSER : GLASS

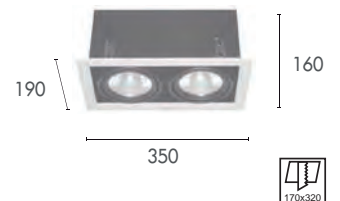

Compatible Bulb	
	CDM-T / G12 35W / 70W / 150W (x2)





500.-

LEO-22111

1-multiple Recessed downlight

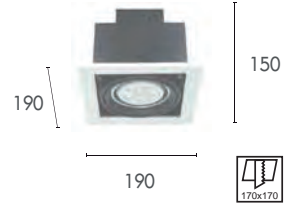
HOUSING : COLD-ROLL STEEL SHEET, COATED WITH POLYESTER POWDER



Compatible Bulb	
	QR111 / G53 12V 50 / 75 / 100W

LED Replacement	
	LED-QR111 / G53 11W / 15W



1,000.-

LEO-22112

2-Multiple Recessed Downlight

HOUSING : COLD-ROLL STEEL SHEET, COATED WITH POLYESTER POWDER



Compatible Bulb	
	QR111 / G53 12V 50 / 75 / 100W

LED Replacement	
	LED-QR111 / G53 11W / 15W



200.-

DL-L141/G-1

Recessed Downlight

HOUSING : COLD-ROLL STEEL SHEET, COATED WITH POLYESTER POWDER

REFLECTOR : ALUMINIUM ANODIZED REFLECTOR

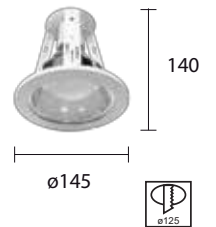

LED Replacement			
	LED-LA60 / E27 7W / 9W (x1)		LED-LA70 / E27 12W / 14W (x1)



120.

DL-L1441/S

Recessed Downlight

HOUSING : COLD-ROLL STEEL SHEET, COATED WITH POLYESTER POWDER

REFLECTOR : ALUMINIUM ANODIZED REFLECTOR

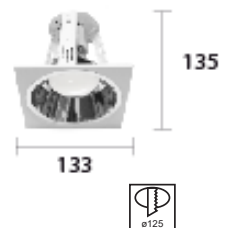

LED Replacement			
	LED-LA60 / E27 7W / 9W (x1)		LED-LA70 / E27 12W / 14W (x1)



รุ่นใหม่ใช้หลอด LED
ประหยัดกว่ารุ่นเก่าถึง 50%

NEW



D-MH301

Recessed Downlight

HOUSING : ALUMINIUM, COATED WITH POLYESTER POWDER

REFLECTOR : ALUMINIUM ANODIZED REFLECTOR

DIFFUSER : GLASS

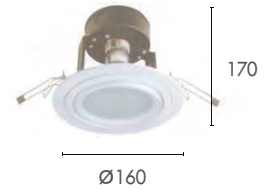

700.-

Compatible Bulb

 CDM-T / G12
35W / 70W (x2)



D-MH103

Recessed Downlight

HOUSING : ALUMINIUM, COATED WITH POLYESTER POWDER

REFLECTOR : ALUMINIUM ANODIZED REFLECTOR

DIFFUSER : GLASS

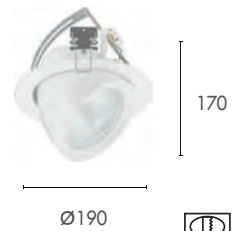

1,500.-

Compatible Bulb

 CDM-T / G12
35W / 70W (x1)



D-MH1001

Recessed Downlight

HOUSING : ALUMINIUM, COATED WITH POLYESTER POWDER

REFLECTOR : ALUMINIUM ANODIZED REFLECTOR

DIFFUSER : GLASS

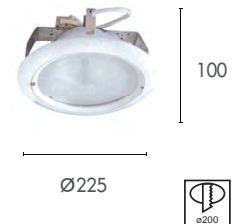

850.-

Compatible Bulb

 MHN-TD/RX
70W / 150W



D-WW-Q603

Recessed Downlight

HOUSING : ALUMINIUM, COATED WITH POLYESTER POWDER

REFLECTOR : ALUMINIUM ANODIZED REFLECTOR

DIFFUSER : GLASS



1,400.-

Compatible Bulb

 MHN-TD/RX
70W / 150W



LEO-4101

Multiple Recessed Downlight

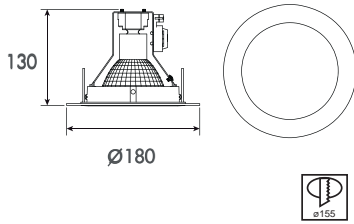

LEO-4100

Multiple Recessed Downlight

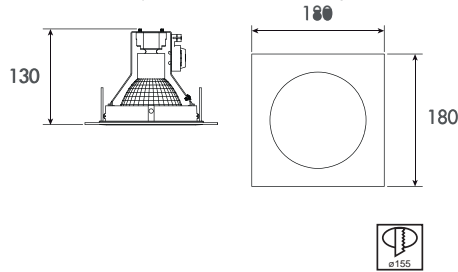

LEO-4200

2-Multiple Recessed Downlight

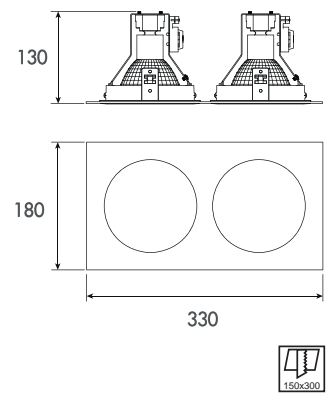

LEO-4300

3-Multiple Recessed Downlight

HOUSING : COLD-ROLL STEEL SHEET, COATED WITH POLYESTER POWDER





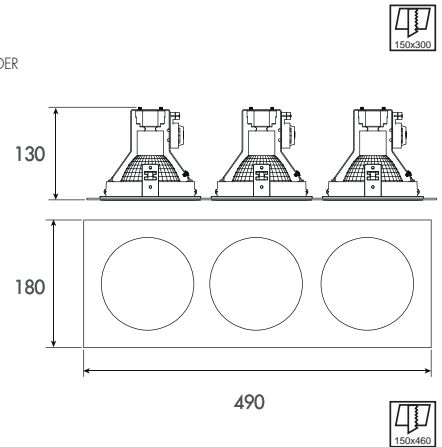





INSTALLATION : RECESSED T-BAR OR GYPSUM MOUNTING

SUITABLE FOR SHOP, HOTEL, SHOWROOM, STORE DECORATION



MAGIC BOX SERIES

1. THE BOARDS ARE MADE OF QUALITY ALUMINIUM MATERIAL AND DIFFERENT COLORS ARE AVAILABLE.
2. THE ANGLE OG LIGHT SOURCES IS ADJUSTABLE.
3. THIS SERIES COULD BE WITH DIFFERENT LIGHT SOURCES, SUCH AS QR111, G12, PAR30 AND E27.
4. BALLAST BOX NEEDS TO BE CONNECTED.
5. FRONT RING CAN BE TURNED OUT FOR CHANGING SOURCE.

MODEL NO.	LAMP HOLDER	COMPATIBLE BULB	PRICE
 LEO-4100-G12	G12	Compatible Bulb  CDM-T / G12 35W / 70W / 150W	1,100.-
 LEO-4100-P30	E27	Compatible Bulb  PAR30 / E27 75W	700.-
 LEO-4100-E27	E27	LED Replacement  LED-PAR30 / E27 12W / 15W	
 LEO-4100-QR111	G53	Compatible Bulb  QR111 / G53 12V 50 / 75 / 100W	700.-
		LED Replacement  LED-LA70 / E27 12W / 14W	
		Compatible Bulb  QR111 / G53 12V 50 / 75 / 100W	420.-
		LED Replacement  LED-QR111 / G53 11W / 15W	



LEO-1103

1-Multiple Recessed Downlight

HOUSING : COLD-ROLL STEEL SHEET, COATED WITH POLYESTER POWDER

INSTALLATION : RECESSED T-BAR OR GYPSUM MOUNTING

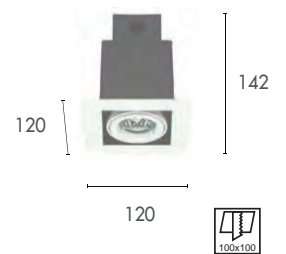

400.-

Compatible Bulb

MR16 / GU5.3
20W / 35W / 50W (x1)

LED Replacement

LED-LHA / GU5.3
5W (x1)

LED-LGU10 / GU10
5.5W (x1)



LEO-1203

2-Multiple Recessed Downlight

HOUSING : COLD-ROLL STEEL SHEET, COATED WITH POLYESTER POWDER

INSTALLATION : RECESSED T-BAR OR GYPSUM MOUNTING

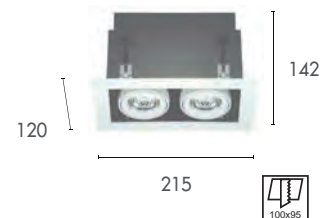

800.-

Compatible Bulb

MR16 / GU5.3
20W / 35W / 50W (x2)

LED Replacement

LED-LHA / GU5.3
5W (x2)

LED-LGU10 / GU10
5.5W (x2)



LEO-1303

3-Multiple Recessed Downlight

HOUSING : COLD-ROLL STEEL SHEET, COATED WITH POLYESTER POWDER

INSTALLATION : RECESSED T-BAR OR GYPSUM MOUNTING

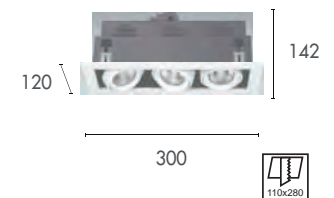

1,350.-

Compatible Bulb

MR16 / GU5.3
20W / 35W / 50W (x3)

LED Replacement

LED-LHA / GU5.3
5W (x3)

LED-LGU10 / GU10
5.5W (x3)



650.-

LEO-20111

1-Multiple Recessed Downlight

HOUSING : COLD-ROLL STEEL SHEET, COATED WITH POLYESTER POWDER

INSTALLATION : RECESSED MOUNTING

SUITABLE FOR SHOP, HOTEL, SHOWROOM, STORE DECORATION

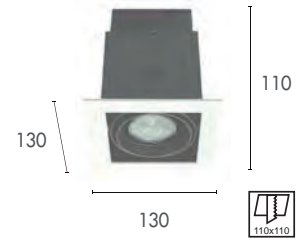

Compatible Bulb	
	MR16 / GU5.3 20W / 35W / 50W (x1)

LED Replacement	
	LED-MR16 / GU5.3 5W (x1)



1,200.-

LEO-20112

2-Multiple Recessed Downlight

HOUSING : COLD-ROLL STEEL SHEET, COATED WITH POLYESTER POWDER

INSTALLATION : RECESSED MOUNTING

SUITABLE FOR SHOP, HOTEL, SHOWROOM, STORE DECORATION



Compatible Bulb	
	MR16 / GU5.3 20W / 35W / 50W (x2)

LED Replacement	
	LED-MR16 / GU5.3 5W (x2)



750.-

LEO-20121

1-Multiple Recessed Downlight

HOUSING : COLD-ROLL STEEL SHEET, COATED WITH POLYESTER POWDER

INSTALLATION : RECESSED MOUNTING

SUITABLE FOR SHOP, HOTEL, SHOWROOM, STORE DECORATION

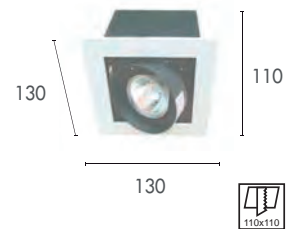

Compatible Bulb	
	MR16 / GU5.3 20W / 35W / 50W (x1)

LED Replacement	
	LED-MR16 / GU5.3 5W (x1)



1,250.-

LEO-20122

3-Multiple Recessed Downlight

HOUSING : COLD-ROLL STEEL SHEET, COATED WITH POLYESTER POWDER

INSTALLATION : RECESSED MOUNTING

SUITABLE FOR SHOP, HOTEL, SHOWROOM, STORE DECORATION

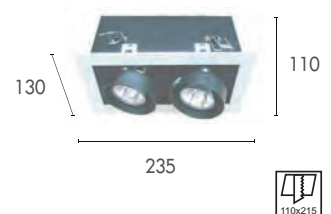

Compatible Bulb	
	MR16 / GU5.3 20W / 35W / 50W (x2)

LED Replacement	
	LED-MR16 / GU5.3 5W (x2)



LEO-12568

Recessed Downlight

HOUSING : ALUMINIUM

INSTALLATION : RECESSED T-BAR OR GYPSUM MOUNTING

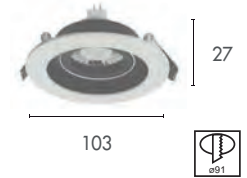

360.-

Compatible Bulb	
	MR16 / GU5.3 50W (x1)

LED Replacement	
	LED-LHA / GU5.3 5W (x1)
	LED-LGU10 / GU10 5.5W (x1)



LEO-12569

Recessed Downlight

HOUSING : ALUMINIUM

INSTALLATION : RECESSED T-BAR OR GYPSUM MOUNTING

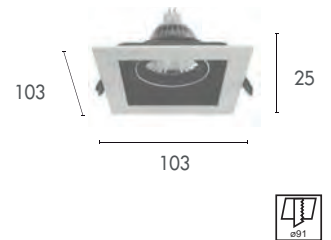

400.-

Compatible Bulb	
	MR16 / GU5.3 50W (x1)

LED Replacement	
	LED-LHA / GU5.3 5W (x1)
	LED-LGU10 / GU10 5.5W (x1)



LEO-12575

Recessed Downlight

HOUSING : ALUMINIUM

INSTALLATION : RECESSED T-BAR OR GYPSUM MOUNTING

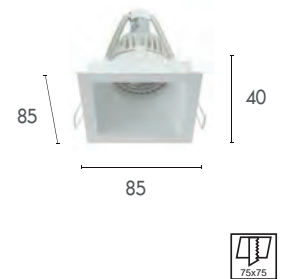

300.-

Compatible Bulb	
	MR16 / GU5.3 50W (x1)

LED Replacement	
	LED-LHA / GU5.3 5W (x1)



LEO-12576

Recessed Downlight

HOUSING : ALUMINIUM

INSTALLATION : RECESSED T-BAR OR GYPSUM MOUNTING

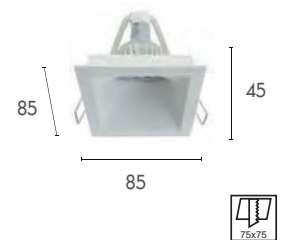

320.-

Compatible Bulb	
	MR16 / GU5.3 50W (x1)

LED Replacement	
	LED-LHA / GU5.3 5W (x1)



800.-

LEO-20019

1-Multiple Recessed Downlight

HOUSING : PURS-ALUMINIUM

INSTALLATION : RECESSED T-BAR OR GYPSUM MOUNTING

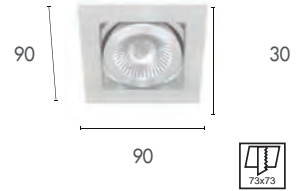

Compatible Bulb

MR16 / GU5.3
50W (x1)

LED Replacement

LED-LHA / GU5.3
5W (x1)

LED-LGU10 / GU5.3
5.5W (x1)



1,600.-

LEO-20020

2-Multiple Recessed Downlight

HOUSING : PURS-ALUMINIUM

INSTALLATION : RECESSED T-BAR OR GYPSUM MOUNTING

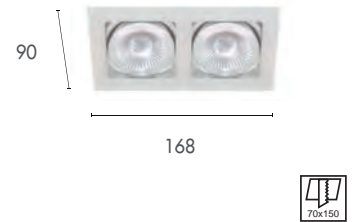

Compatible Bulb

MR16 / GU5.3
50W (x2)

LED Replacement

LED-LHA / GU5.3
5W (x2)

LED-LGU10 / GU5.3
5.5W (x1)



560.-

LEO-21816

1-Multiple Recessed Downlight

HOUSING : COLD-ROLL STEEL SHEET, COATED WITH POLYESTER POWDER

INSTALLATION : RECESSED T-BAR OR GYPSUM MOUNTING

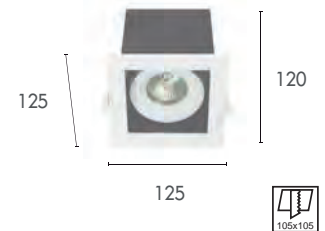

Compatible Bulb

MR16 / GU5.3
50W (x1)

LED Replacement

LED-LHA / GU5.3
5W (x1)

ALUMINIUM TRIM



900.-

LEO-22816

2-Multiple Recessed Downlight

HOUSING : COLD-ROLL STEEL SHEET, COATED WITH POLYESTER POWDER

INSTALLATION : RECESSED T-BAR OR GYPSUM MOUNTING

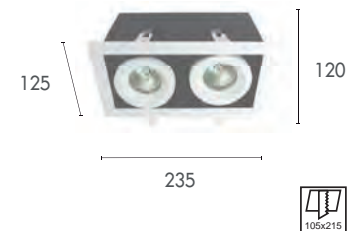

Compatible Bulb

MR16 / GU5.3
50W (x2)

LED Replacement

LED-LHA / GU5.3
5W (x2)

ALUMINIUM TRIM



300.-

LEO-20009

1-Multiple Recessed Downlight

HOUSING : COLD-ROLL STEEL SHEET, COATED WITH POLYESTER POWDER

INSTALLATION : RECESSED T-BAR OR GYPSUM MOUNTING



Compatible Bulb	
	MR16 / GU5.3 50W (x1)

LED Replacement			
	LED-LHA / GU5.3 5W (x1)		LED-LGU10 / GU10 5.5W (x1)



250.-

LEO-20010

1-Multiple Recessed Downlight

HOUSING : COLD-ROLL STEEL SHEET, COATED WITH POLYESTER POWDER

INSTALLATION : RECESSED T-BAR OR GYPSUM MOUNTING

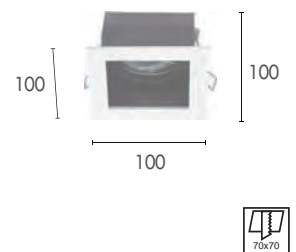

Compatible Bulb	
	MR16 / GU5.3 50W (x1)

LED Replacement			
	LED-LHA / GU5.3 5W (x1)		LED-LGU10 / GU10 5.5W (x1)



500.-

LEO-20010-2

2-Multiple Recessed Downlight

HOUSING : COLD-ROLL STEEL SHEET, COATED WITH POLYESTER POWDER

INSTALLATION : RECESSED T-BAR OR GYPSUM MOUNTING

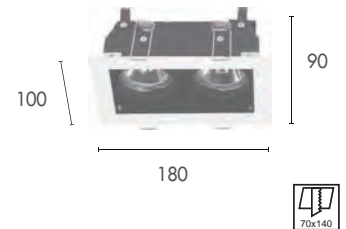

Compatible Bulb	
	MR16 / GU5.3 50W (x2)

LED Replacement			
	LED-LHA / GU5.3 5W (x2)		LED-LGU10 / GU10 5.5W (x2)



750.-

LEO-20010-3

3-Multiple Recessed Downlight

HOUSING : COLD-ROLL STEEL SHEET, COATED WITH POLYESTER POWDER

INSTALLATION : RECESSED T-BAR OR GYPSUM MOUNTING



Compatible Bulb	
	MR16 / GU5.3 50W (x3)

LED Replacement			
	LED-LHA / GU5.3 5W (x3)		LED-LGU10 / GU10 5.5W (x3)



280.-

DH-521

1-Multiple Recessed Downlight

HOUSING : ALUMINIUM, COATED WITH POLYESTER POWDER

INSTALLATION : RECESSED T-BAR OR GYPSUM MOUNTING

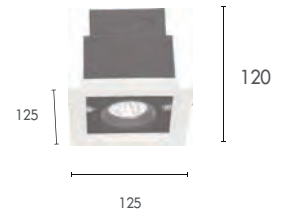

Compatible Bulb

MR16 / GU5.3
50W (x1)

LED Replacement

LED-LHA / GU5.3
5W (x1)

LED-LGU10 / GU10
5.5W (x1)



480.-

DH-522

2-Multiple Recessed Downlight

HOUSING : ALUMINIUM, COATED WITH POLYESTER POWDER

INSTALLATION : RECESSED T-BAR OR GYPSUM MOUNTING



Compatible Bulb

MR16 / GU5.3
50W (x2)

LED Replacement

LED-LHA / GU5.3
5W (x2)

LED-LGU10 / GU10
5.5W (x1)



580.-

DH-111/A

Recessed Horizontal Downlight

HOUSING : COLD-ROLL STEEL SHEET, COATED WITH POLYESTER POWDER

REFLECTOR : ALUMINIUM ANODIZED REFLECTOR

INSTALLATION : RECESSED MOUNTING



DH-111/B



Compatible Bulb

MR16 / GU5.3
50W (x1)

LED Replacement

LED-LHA / GU5.3
5W (x1)



600.-

DH-141/A

Recessed Horizontal Downlight

HOUSING : COLD-ROLL STEEL SHEET, COATED WITH POLYESTER POWDER

REFLECTOR : ALUMINIUM ANODIZED REFLECTOR

INSTALLATION : RECESSED MOUNTING



DH-141/B



Compatible Bulb

MR16 / GU5.3
50W (x1)

LED Replacement

LED-LHA / GU5.3
5W (x1)



DH-531

1-Multiple Recessed Downlight

HOUSING : COLD-ROLL STEEL SHEET, COATED WITH POLYESTER POWDER

INSTALLATION : RECESSED T-BAR OR GYPSUM MOUNTING

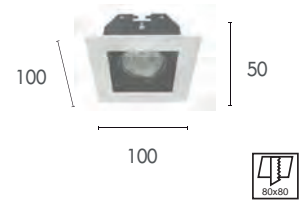

220.-

Compatible Bulb

MR16 / GU5.3
50W (x1)

LED Replacement

LED-LHA / GU5.3
5W (x1)

LED-LGU10 / GU10
5.5W (x1)



DH-532

2-Multiple Recessed Downlight

HOUSING : COLD-ROLL STEEL SHEET, COATED WITH POLYESTER POWDER

INSTALLATION : RECESSED T-BAR OR GYPSUM MOUNTING

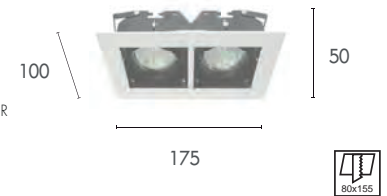

440.-

Compatible Bulb

MR16 / GU5.3
50W (x2)

LED Replacement

LED-LHA / GU5.3
5W (x2)

LED-LGU10 / GU10
5.5W (x2)



DH-533

3-Multiple Recessed Downlight

HOUSING : COLD-ROLL STEEL SHEET, COATED WITH POLYESTER POWDER

INSTALLATION : RECESSED T-BAR OR GYPSUM MOUNTING

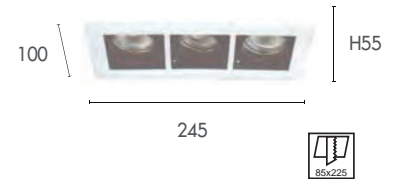

680.-

Compatible Bulb

MR16 / GU5.3
50W (x3)

LED Replacement

LED-LHA / GU5.3
5W (x3)

LED-LGU10 / GU10
5.5W (x3)



DH-534

1-Multiple Recessed Downlight

HOUSING : COLD-ROLL STEEL SHEET, COATED WITH POLYESTER POWDER

INSTALLATION : RECESSED T-BAR OR GYPSUM MOUNTING

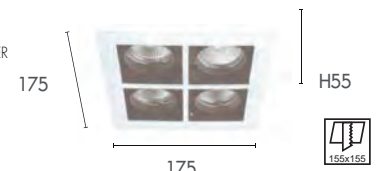

960.-

Compatible Bulb

MR16 / GU5.3
50W (x4)

LED Replacement

LED-LHA / GU5.3
5W (x4)

LED-LGU10 / GU10
5.5W (x4)



LEO-20010-G

1-Multiple Recessed Downlight

HOUSING : COLD-ROLL STEEL SHEET, COATED WITH POLYESTER POWDER

INSTALLATION : RECESSED T-BAR OR GYPSUM MOUNTING

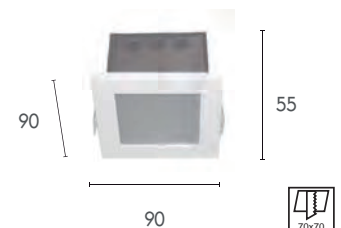

350.-

Compatible Bulb

MR16 / GU5.3
50W (x1)

LED Replacement

LED-LHA / GU5.3
5W (x1)

LED-LGU10 / GU10
5.5W (x1)



450.-

LEO-20783

Recessed Downlight

HOUSING : COLD-ROLL STEEL SHEET, COATED WITH POLYESTER POWDER

INSTALLATION : RECESSED MOUNTING



Ø87

100



Compatible Bulb

MR16 / GU5.3
50W (x1)

LED Replacement

LED-LHA / GU5.3
5W (x1)



450.-

LEO-20784

Recessed Downlight

HOUSING : COLD-ROLL STEEL SHEET, COATED WITH POLYESTER POWDER

INSTALLATION : RECESSED MOUNTING



Ø87

100



Compatible Bulb

MR16 / GU5.3
50W (x1)

LED Replacement

LED-LHA / GU5.3
5W (x1)



320.-

LEO-20022-R

Recessed Downlight

HOUSING : COLD-ROLL STEEL SHEET, COATED WITH POLYESTER POWDER

INSTALLATION : RECESSED MOUNTING



Ø92

80



Compatible Bulb

MR16 / GU5.3
50W (x1)

LED Replacement

LED-LHA / GU5.3
5W (x1)



280.-

LEO-20222

Recessed Downlight

HOUSING : COLD-ROLL STEEL SHEET, COATED WITH POLYESTER POWDER

INSTALLATION : RECESSED T-BAR OR GYPSUM MOUNTING



Ø75

80



Compatible Bulb

MR16 / GU5.3
50W (x1)

LED Replacement

LED-LHA / GU5.3
5W (x1)



DH-101

Recessed Downlight

HOUSING : DIE-CAST ALUMINIUM

INSTALLATION : RECESSED T-BAR OR GYPSUM MOUNTING

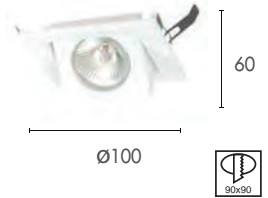

160.-

Compatible Bulb	
	MR16 / GU5.3 50W (x1)

LED Replacement	
	LED-LHA / GU5.3 5W (x1)



DH-102

Recessed Downlight

HOUSING : DIE-CAST ALUMINIUM

INSTALLATION : RECESSED T-BAR OR GYPSUM MOUNTING

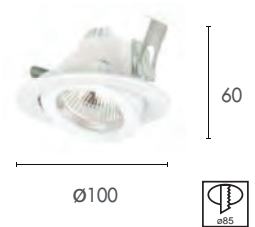

160.-

Compatible Bulb	
	MR16 / GU5.3 50W (x1)

LED Replacement	
	LED-LHA / GU5.3 5W (x1)



DH-103W

Recessed Downlight

HOUSING : DIE-CAST ALUMINIUM

INSTALLATION : RECESSED T-BAR OR GYPSUM MOUNTING



160.-

Compatible Bulb	
	MR16 / GU5.3 50W (x1)

LED Replacement	
	LED-LHA / GU5.3 5W (x1)



DH-103S

440.-



DH-104W

Recessed Downlight

HOUSING : DIE-CAST ALUMINIUM

INSTALLATION : RECESSED T-BAR OR GYPSUM MOUNTING

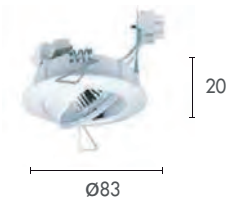

140.-

Compatible Bulb	
	MR16 / GU5.3 50W (x1)

LED Replacement	
	LED-LHA / GU5.3 5W (x1)



DH-104S

160.-



DH-104G

160.-





130.-

DH-514W

Recessed Downlight

HOUSING : DIE-CAST ALUMINIUM

INSTALLATION : RECESSED T-BAR OR GYPSUM MOUNTING



H30

Ø 80



DH-514S

150.-



Compatible Bulb

MR16 / GU5.3
50W (x1)

LED Replacement

LED-LHA / GU5.3
5W (x1)



160.-

DH-504W

Recessed Downlight

HOUSING : DIE-CAST ALUMINIUM

INSTALLATION : RECESSED T-BAR OR GYPSUM MOUNTING



H35

Ø 95



DH-504S

220.-



Compatible Bulb

MR16 / GU5.3
50W (x1)

LED Replacement

LED-LHA / GU5.3
5W (x1)



140.-

DH-41

Recessed Downlight

HOUSING : DIE-CAST ALUMINIUM

INSTALLATION : RECESSED T-BAR OR GYPSUM MOUNTING



H20

80



DH-42

170.-



DH-43

170.-



Compatible Bulb

MR16 / GU5.3
50W (x1)

LED Replacement

LED-LHA / GU5.3
5W (x1)



DH-170

Recessed Downlight

HOUSING : DIE-CAST ALUMINIUM

INSTALLATION : RECESSED T-BAR OR GYPSUM MOUNTING

DIFFUSER : GLASS

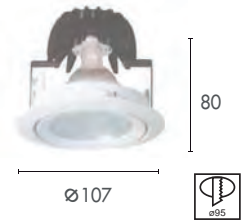

500.-

Compatible Bulb	
	MR16 / GU5.3 50W (x1)

LED Replacement	
	LED-LHA / GU5.3 5W (x1)



DH-264

Recessed Downlight

HOUSING : DIE-CAST ALUMINIUM

INSTALLATION : RECESSED T-BAR OR GYPSUM MOUNTING

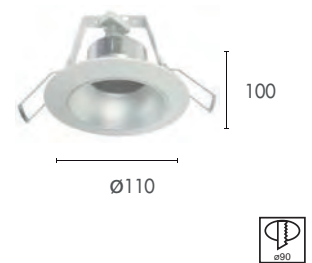

300.-

Compatible Bulb	
	MR16 / GU5.3 50W (x1)

LED Replacement	
	LED-LHA / GU5.3 5W (x1)



DH-505W

Recessed Downlight

HOUSING : DIE-CAST ALUMINIUM

INSTALLATION : RECESSED T-BAR OR GYPSUM MOUNTING



120.-

Compatible Bulb	
	MR16 / GU5.3 50W (x1)

LED Replacement	
	LED-LHA / GU5.3 5W (x1)



DH-11/MR11

Recessed Downlight

HOUSING : DIE-CAST ALUMINIUM

INSTALLATION : RECESSED T-BAR OR GYPSUM MOUNTING



120.-

Compatible Bulb	
	MR11 20W (x1)

LED Replacement	
	LED-MR11 3W (x1)



480.-

LEO-21515

Recessed Downlight

HOUSING : ALUMINIUM, COATED WITH POLYESTER POEDER

REFLECTOR : ALUMINIUM

INSTALLATION : RECESSED T-BAR OR GYPSUM MOUNTING

Compatible Bulb	
	MR16 / GU5.3 50W (x1)

LED Replacement	
	LED-LHA / GU5.3 5W (x1)



105

Ø103



480.-

LEO-21516

Recessed Downlight

HOUSING : ALUMINIUM, COATED WITH POLYESTER POEDER

REFLECTOR : ALUMINIUM

INSTALLATION : RECESSED T-BAR OR GYPSUM MOUNTING

Compatible Bulb	
	MR16 / GU5.3 50W (x1)

LED Replacement	
	LED-LHA / GU5.3 5W (x1)



105

Ø103



400.-

DH-719JC

Recessed Downlight

HOUSING : ALUMINIUM, COATED WITH POLYESTER POEDER

INSTALLATION : RECESSED T-BAR OR GYPSUM MOUNTING

SUITABLE FOR SHOP, HOTEL, SHOWROOM, STORE DECORATION
DIFFUSER : GLASS

Compatible Bulb	
	JC / GU5.3 50W (x1)

LED Replacement	
	LED-JC 3W (x1)

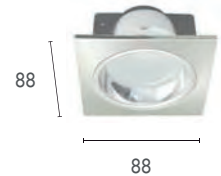

88

H55

88



DH-975JC
300.-
(300x300)



DH-917JC
300.-
(300x170)



Recessed Downlight

HOUSING : ALUMINIUM, COATED WITH POLYESTER POEDER

INSTALLATION : RECESSED T-BAR OR GYPSUM MOUNTING

DIFFUSER : GLASS

Compatible Bulb	
	JC 20W (x1)

LED Replacement	
	LED-G4 1.5W (x1)

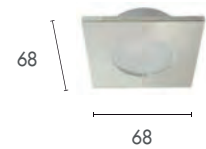

68

H25

68



73

H23

73





320.-

LEO-20001

Recessed Downlight

HOUSING : PURE-ALUMINIUM

INSTALLATION : RECESSED T-BAR OR GYPSUM MOUNTING



Compatible Bulb		LED Replacement	
	MR16 / GU5.3 50W (x1)		LED-LHA / GU5.3 5W (x1)
			LED-LGU10 / GU10 5.5W (x1)



650.-

LEO-20002

Recessed Downlight

HOUSING : PURE-ALUMINIUM

INSTALLATION : RECESSED T-BAR OR GYPSUM MOUNTING



Compatible Bulb		LED Replacement	
	MR16 / GU5.3 50W (x2)		LED-LHA / GU5.3 5W (x2)
			LED-LGU10 / GU10 5.5W (x2)



950.-

LEO-20003

Recessed Downlight

HOUSING : PURE-ALUMINIUM

INSTALLATION : RECESSED T-BAR OR GYPSUM MOUNTING



Compatible Bulb		LED Replacement	
	MR16 / GU5.3 50W (x3)		LED-LHA / GU5.3 5W (x3)
			LED-LGU10 / GU10 5.5W (x3)



320.-

LEO-20022

Recessed Downlight

HOUSING : ALUMINIUM

INSTALLATION : RECESSED T-BAR OR GYPSUM MOUNTING

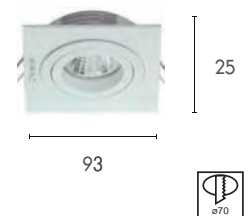

Compatible Bulb		LED Replacement	
	MR16 / GU5.3 50W (x1)		LED-LHA / GU5.3 5W (x1)
			LED-LGU10 / GU10 5.5W (x1)



DH-751

1-multiple Recessed downlight

HOUSING : ALUMINIUM COATED WITH POLYESTER POWDER

INSTALLATION : RECESSED T-BAR OR GYPSUM MOUNTING

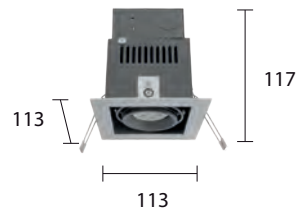

300.-

Compatible Bulb

MR16 / GU5.3
50W (x1)

LED Replacement

LED-LHA / GU5.3
5W (x1)

LED-LGU10 / GU10
5.5W (x1)



DH-752

2-Multiple Recessed Downlight

HOUSING : ALUMINIUM COATED WITH POLYESTER POWDER

INSTALLATION : RECESSED T-BAR OR GYPSUM MOUNTING

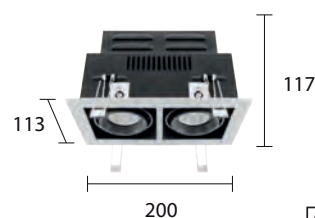

600.-

Compatible Bulb

MR16 / GU5.3
50W (x1)

LED Replacement

LED-LHA / GU5.3
5W (x1)

LED-LGU10 / GU10
5.5W (x1)





DB-421

Surface Mounted Downlight

HOUSING : COLD ROLL STEEL SHEET, COATED WITH POLYESTER POWDER

REFLECTOR : ALUMINIUM REFLECTOR

INSTALLATION : SURFACE MOUNTING OR PENDANT

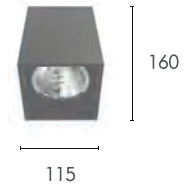

Compatible Bulb	
	GENIE / E27 11W (x1)

LED Replacement	
	LED-LA60 / E27 7W / 9W (x1)



DB-441

Surface Mounted Downlight

HOUSING : COLD ROLL STEEL SHEET, COATED WITH POLYESTER POWDER

REFLECTOR : ALUMINIUM REFLECTOR

INSTALLATION : SURFACE MOUNTING OR PENDANT

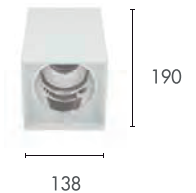

Compatible Bulb	
	GENIE / E27 14W (x1)

LED Replacement	
	LED-LA60 / E27 7W / 9W (x1)



DB-471

Surface Mounted Downlight

HOUSING : COLD ROLL STEEL SHEET, COATED WITH POLYESTER POWDER

REFLECTOR : ALUMINIUM REFLECTOR

INSTALLATION : SURFACE MOUNTING OR PENDANT



Compatible Bulb	
	TORNADO / E27 24W (x1)

LED Replacement	
	LED-LA70 / E27 12W / 14W (x1)





400.-

DB-47/BK

Surface Mounted Downlight

HOUSING : COLD ROLL STEEL SHEET, COATED WITH POLYESTER POWDER

INSTALLATION : SURFACE MOUNTING OR PENDANT



175

Compatible Bulb	
	GENIE / E27 14W (x1)

LED Replacement	
	LED-LA60 / E27 7W / 9W (x1)



350.-

DB-141

Surface Mounted Downlight

HOUSING : COLD ROLL STEEL SHEET, COATED WITH POLYESTER POWDER

REFLECTOR : ALUMINIUM REFLECTOR

INSTALLATION : SURFACE MOUNTING OR PENDANT



160

Compatible Bulb	
	GENIE / E27 14W (x1)

LED Replacement	
	LED-LA60 / E27 7W / 9W (x1)



550.-

DB-171

Surface Mounted Downlight

HOUSING : COLD ROLL STEEL SHEET, COATED WITH POLYESTER POWDER

REFLECTOR : ALUMINIUM REFLECTOR

INSTALLATION : SURFACE MOUNTING OR PENDANT



190

Compatible Bulb	
	TORNADO / E27 24W (x1)

LED Replacement	
	LED-LA70 / E27 12W / 14W (x1)



700.-

DB-171G

Surface Mounted Downlight

HOUSING : COLD ROLL STEEL SHEET, COATED WITH POLYESTER POWDER

REFLECTOR : ALUMINIUM REFLECTOR

INSTALLATION : SURFACE MOUNTING OR PENDANT

DIFFUSER : GLASS



190

Compatible Bulb	
	TORNADO / E27 24W (x1)

LED Replacement	
	LED-LA70 / E27 12W / 14W (x1)





DB-3092-B

Surface Mounted Downlight

HOUSING : COLD ROLL STEEL SHEET, COATED WITH POLYESTER POWDER

REFLECTOR : ALUMINIUM REFLECTOR

INSTALLATION : SURFACE MOUNTING OR PENDANT

SUITABLE FOR GENERAL DECORATION SUCH AS SHOPS, RESTAURANTS, ETC

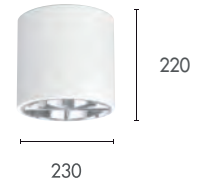

Compatible Bulb	
 PLC/G24-d 13W / 18W (x1)	 GENIE / E27 14W / 18W (x1)



Model	Lamp holder	Source	Voltage	Power
DB-3902-B	G24-q/G24-d/E27	TC-DEL/TC-D/TC-TSE	230V 50Hz	1x18W/2x18W/1x26W/2x26W

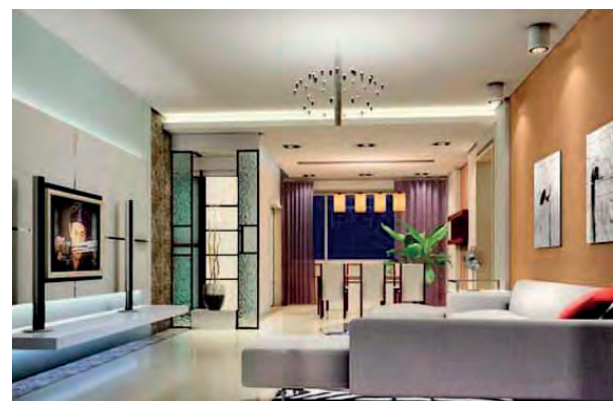
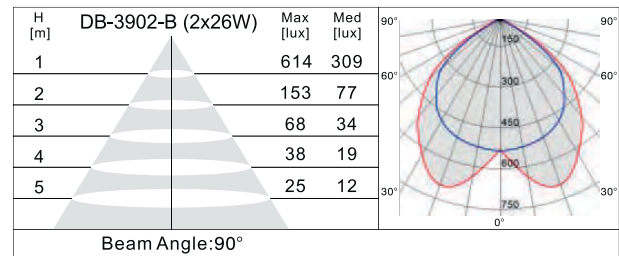
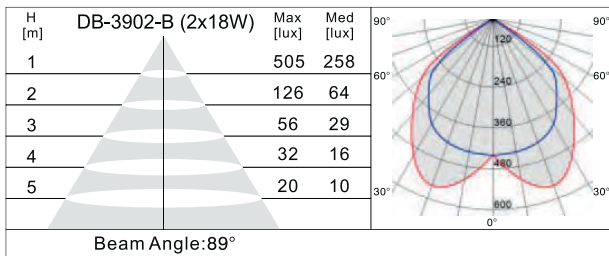
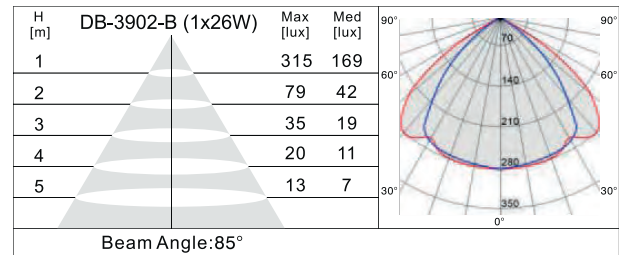
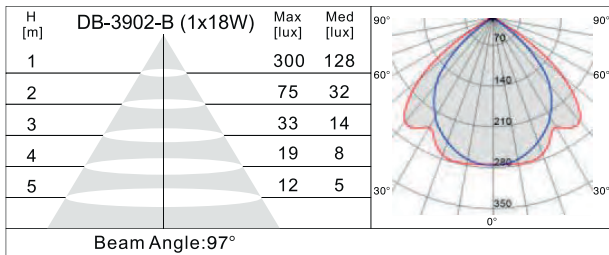

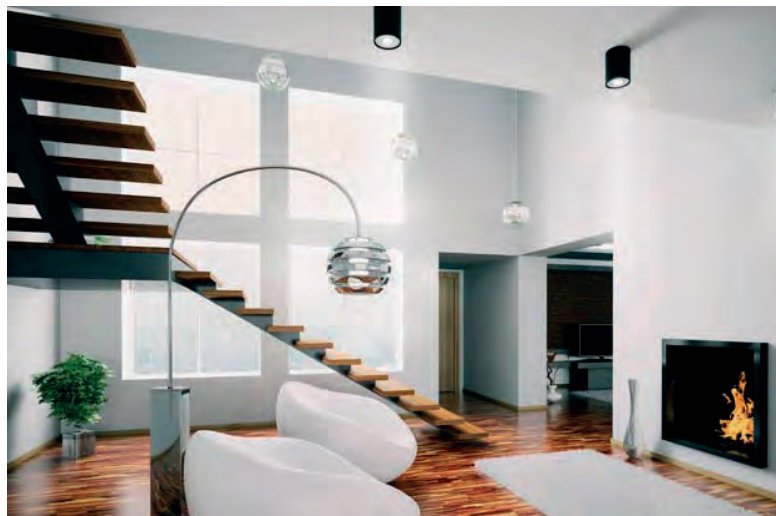

1,100.-

DB-5600-1

1-Multiple Surface Downlight

HOUSING : COLD ROLL STEEL SHEET, COATED WITH POLYESTER POWDER

REFLECTOR : ALUMINIUM REFLECTOR

INSTALLATION : SURFACE MOUNTING OR PENDANT

SUITABLE FOR GENERAL DECORATION SUCH AS SHOPS, RESTAURANTS, ETC.



125

Ø95

Compatible Bulb



GU10
50W (x1)

LED Replacement



LED-GU10
5W (x1)



2,000.-

DB-5600-2

2-Multiple Surface Downlight

HOUSING : COLD ROLL STEEL SHEET, COATED WITH POLYESTER POWDER

REFLECTOR : ALUMINIUM REFLECTOR

INSTALLATION : SURFACE MOUNTING OR PENDANT

SUITABLE FOR SHOP, HOTEL, SHOWROOM, STORE DECORATION

DIFFUSER : GLASS



100

120

180

Compatible Bulb



GU10
50W (x2)

LED Replacement



LED-GU10
5W (x2)



DB-5601

1-Multiple Surface Downlight

HOUSING : COLD ROLL STEEL SHEET, COATED WITH POLYESTER POWDER

INSTALLATION : SURFACE MOUNTING OR PENDANT

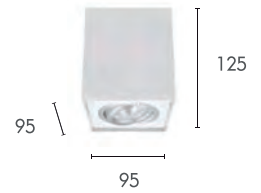

1,000.-

Compatible Bulb



LED Replacement



DB-5602

2-Multiple Surface Downlight

HOUSING : COLD ROLL STEEL SHEET, COATED WITH POLYESTER POWDER

INSTALLATION : SURFACE MOUNTING OR PENDANT

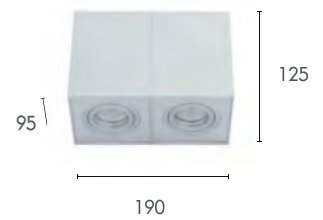

2,200.-

Compatible Bulb



LED Replacement



DB-5901-QR111

1-Multiple Surface Downlight

HOUSING : COLD ROLL STEEL SHEET, COATED WITH POLYESTER POWDER

INSTALLATION : SURFACE MOUNTING OR PENDANT



1,150.-

Compatible Bulb



DB-5902-QR111

2-Multiple Surface Downlight

HOUSING : COLD ROLL STEEL SHEET, COATED WITH POLYESTER POWDER

INSTALLATION : SURFACE MOUNTING OR PENDANT



2,300.-

Compatible Bulb





1,100.-

LEO-30121

1-Multiple Surface Downlight

HOUSING : COLD ROLL STEEL SHEET, COATED WITH POLYESTER POWDER

INSTALLATION : SURFACE MOUNTING OR PENDANT

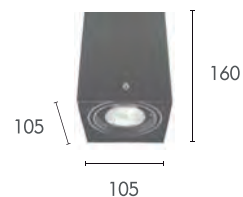

Compatible Bulb	
	MR16 / GU5.3 50W (x1)

LED Replacement	
	LED-LHA / GU5.3 5W (x1)



2,000.-

LEO-30122

2-Multiple Surface Downlight

HOUSING : COLD ROLL STEEL SHEET, COATED WITH POLYESTER POWDER

INSTALLATION : SURFACE MOUNTING OR PENDANT

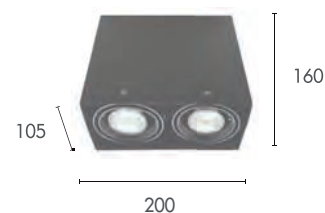

Compatible Bulb	
	MR16 / GU5.3 50W (x1)

LED Replacement	
	LED-LHA / GU5.3 5W (x1)



1,200.-

LEO-31511

1-Multiple Surface Downlight

HOUSING : COLD ROLL STEEL SHEET, COATED WITH POLYESTER POWDER

INSTALLATION : SURFACE MOUNTING OR PENDANT

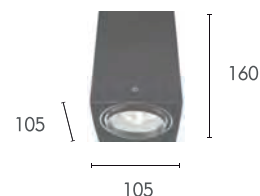

Compatible Bulb	
	GENIE / E27 14W (x1)

LED Replacement	
	LED-LA60 / E27 7W / 9W (x1)

LED Replacement	
	LED-LGU10 / GU10 5.5W (x1)



2,200.-

LEO-31512

2-Multiple Surface Downlight

HOUSING : COLD ROLL STEEL SHEET, COATED WITH POLYESTER POWDER

INSTALLATION : SURFACE MOUNTING OR PENDANT

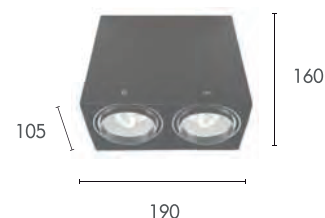

Compatible Bulb	
	GENIE / E27 14W (x1)

LED Replacement	
	LED-LA60 / E27 7W / 9W (x1)

LED Replacement	
	LED-LGU10 / GU10 5.5W (x1)



1,500.-

LEO-33111

1-Multiple Surface Downlight

HOUSING : COLD-ROLL STEEL SHEET, COATED WITH POLYESTER POWDER

REFLECTOR : ALUMINIUM REFLECTOR

INSTALLATION : SURFACE MOUNTING OR PENDANT

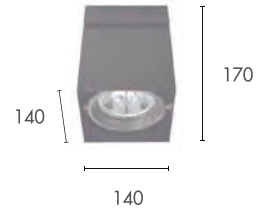

Compatible Bulb	
	QR111 / G53 12V 50 / 75 / 100W (x1)

LED Replacement	
	LED-QR111 / G53 11W / 15W (x1)



2,500.-

LEO-33112

2-Multiple Surface Downlight

HOUSING : COLD-ROLL STEEL SHEET, COATED WITH POLYESTER POWDER

REFLECTOR : ALUMINIUM REFLECTOR

INSTALLATION : SURFACE MOUNTING OR PENDANT

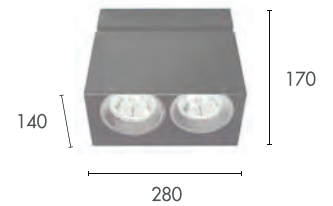

Compatible Bulb	
	QR111 / G53 12V 50 / 75 / 100W (x2)

LED Replacement	
	LED-QR111 / G53 11W / 15W (x2)



1,800.-

LEO-34115

1-Multiple Surface Downlight

HOUSING : COLD-ROLL STEEL SHEET, COATED WITH POLYESTER POWDER

REFLECTOR : ALUMINIUM REFLECTOR

INSTALLATION : SURFACE MOUNTING OR PENDANT

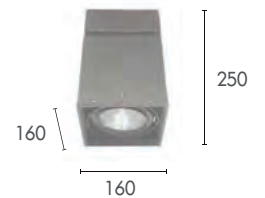

Compatible Bulb	
	CDM-T / G12 35W / 70W / 150W (x1)



2,800.-

LEO-34215

2-Multiple Surface Downlight

HOUSING : COLD-ROLL STEEL SHEET, COATED WITH POLYESTER POWDER

REFLECTOR : ALUMINIUM REFLECTOR

INSTALLATION : SURFACE MOUNTING OR PENDANT

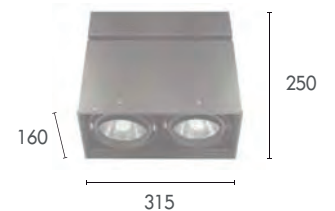

Compatible Bulb	
	CDM-T / G12 35W / 70W / 150W (x2)

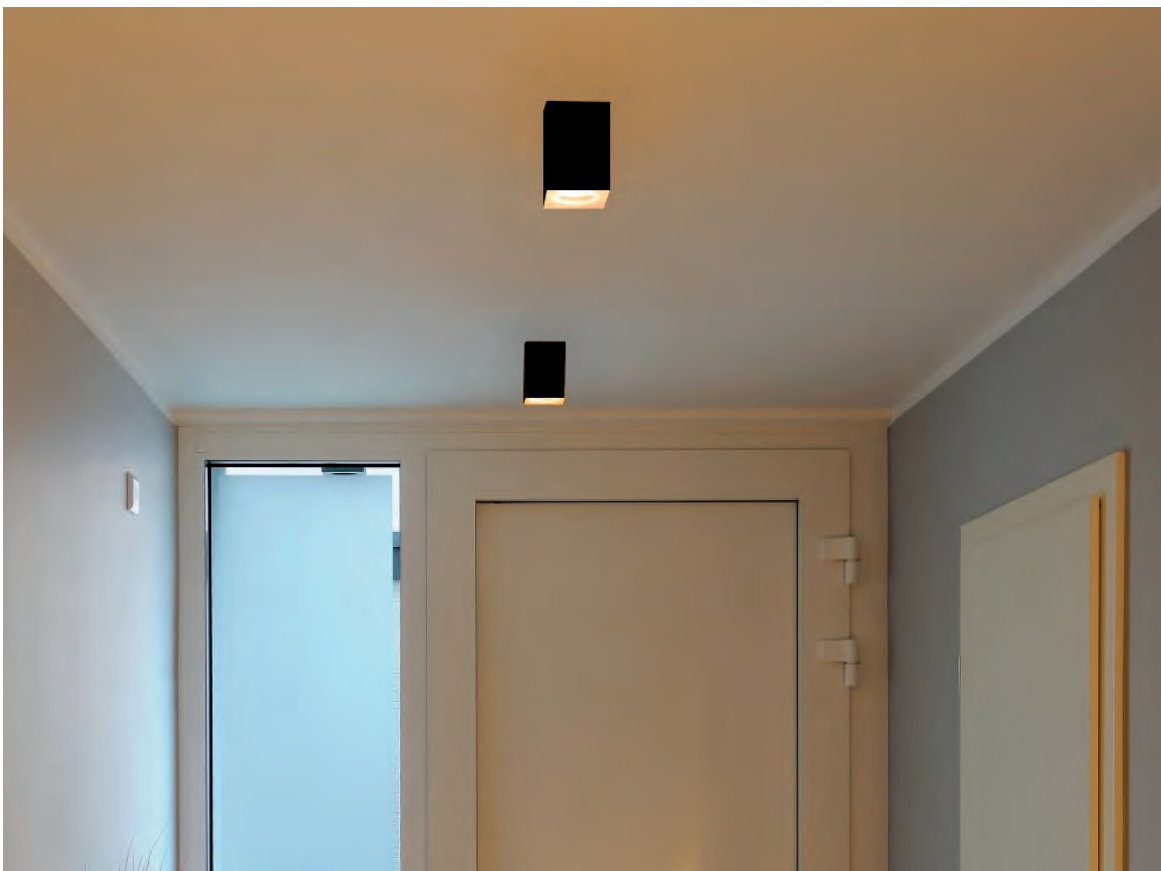

1,800.-

LEO-31711

1-Multiple Surface Downlight

HOUSING : COLD-ROLL STEEL SHEET, COATED WITH POLYESTER POWDER

REFLECTOR : ALUMINIUM REFLECTOR

INSTALLATION : SURFACE MOUNTING OR PENDANT

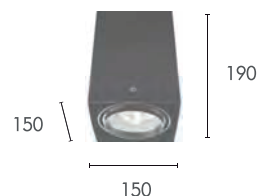

Compatible Bulb



TORNADO / E27
24W (x1)

LED Replacement



LED-LA70 / E27
12W / 14W (x1)



3,200.-

LEO-31712

2-Multiple Surface Downlight

HOUSING : COLD-ROLL STEEL SHEET, COATED WITH POLYESTER POWDER

REFLECTOR : ALUMINIUM REFLECTOR

INSTALLATION : SURFACE MOUNTING OR PENDANT



Compatible Bulb



TORNADO / E27
24W (x2)

LED Replacement



LED-LA70 / E27
12W / 14W (x2)



DBO-C111/L

Surface Mounted Downlight

HOUSING : ALUMINIUM / GLASS

REFLECTOR : ALUMINIUM REFLECTOR

INSTALLATION : SURFACE MOUNTING OR PENDANT



1,000.-

Compatible Bulb	
	TORNADO / E27 14W (x1)



DBO-C121/L

Surface Mounted Downlight

HOUSING : ALUMINIUM / GLASS

REFLECTOR : ALUMINIUM REFLECTOR

INSTALLATION : SURFACE MOUNTING OR PENDANT



1,600.-

Compatible Bulb	
	TORNADO / E27 24W (x1)



DBO-C191/L

Surface Mounted Downlight

HOUSING : ALUMINIUM / GLASS

INSTALLATION : SURFACE MOUNTING OR PENDANT

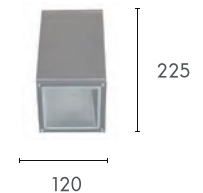

1,400.-

Compatible Bulb	
	TORNADO / E27 24W (x1)

OUTDOOR DOWNLIGHT IP65

MATERIAL : ALUMINIUM / GLASS

REFLECTOR : ALUMINIUM



HDR-7302

E27 PAR38 120W 4,200.- (โคมเปล่า)
 G24 PLC 26W 4,630.- (พร้อมบัลลาสต์)
 G12 CDM-T 35X70W 7,900.- (พร้อมบัลลาสต์)

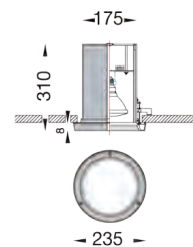

HDR-7312

E27 PAR20 50W 2,500.- (โคมเปล่า)
 GU10 LED 220V 5W 2,600.- (โคมเปล่า)

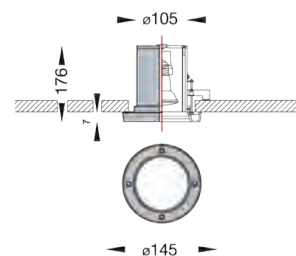

HDR-7322

E27 PAR30 75W 4,700.- (โคมเปล่า)
 G12 CDM-T 35,70W 7,990.- (พร้อมบัลลาสต์)

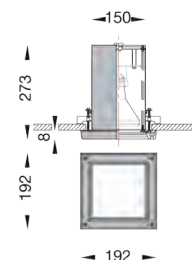

HDR-7332

E27 PAR20 50W 2,700.- (โคมเปล่า)
 G10 LED 220V 5W 2,800.- (โคมเปล่า)

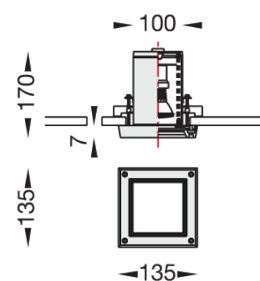



LEO-S423-1

1-Multiple Recessed Downlight

HOUSING : COLD ROLL STEEL SHEET, COATED WITH POLYESTER POWDER

REFLECTOR : ALUMINIUM ANODIZED REFLECTOR

INSTALLATION : RECESSED T-BAR OR GYPSUM MOUNTING

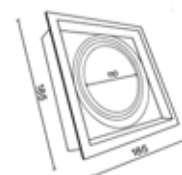

850.-



Compatible Bulb	
	TORNADO / E27 24W (x1)

LED Replacement	
	LED-LA70 / E27 14W (x1)



LEO-S423-2

2-Multiple Recessed Downlight

HOUSING : COLD ROLL STEEL SHEET, COATED WITH POLYESTER POWDER

REFLECTOR : ALUMINIUM ANODIZED REFLECTOR

INSTALLATION : RECESSED T-BAR OR GYPSUM MOUNTING

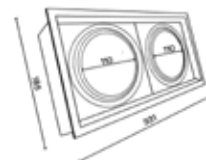

1,700.-



Compatible Bulb	
	TORNADO / E27 24W (x2)

LED Replacement	
	LED-LA70 / E27 14W (x2)



DP-0206/QR

2-Multiple Recessed Downlight

HOUSING : COLD-ROLL STEEL SHEET, COATED WITH POLYESTER POWDER

INSTALLATION : RECESSED T-BAR OR GYPSUM MOUNTING

SUITABLE FOR SHOP, HOTEL, SHOWROOM, STORE DECORATION

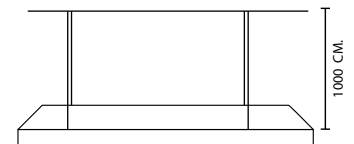
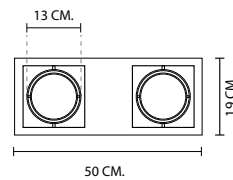

*สลิงยาว 1 เมตร

LED Replacement



LED-QR111
12W(x2)

DP-0306/QR

3-Multiple Recessed Downlight

HOUSING : COLD-ROLL STEEL SHEET, COATED WITH POLYESTER POWDER

INSTALLATION : RECESSED T-BAR OR GYPSUM MOUNTING

SUITABLE FOR SHOP, HOTEL, SHOWROOM, STORE DECORATION

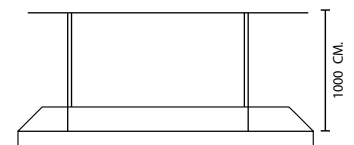
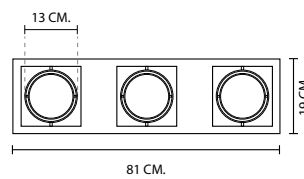

*สลิงยาว 1 เมตร

LED Replacement



LED-QR111
12W(x3)



280.-



LEO-10222/WH

Recessed Downlight

HOUSING : COLD-ROLL STEEL SHEET, COATED WITH POLYESTER POWDER

INSTALLATION: RECESSED T-BAR OR GYPSUM MOUNTING



LED Replacement			
	LED-LA60 / E27 7W / 9W (x1)		LED-LA70 / E27 12W / 14W (x1)



280.-



LEO-10222/BK

Recessed Downlight

HOUSING : COLD-ROLL STEEL SHEET, COATED WITH POLYESTER POWDER

INSTALLATION: RECESSED T-BAR OR GYPSUM MOUNTING



LED Replacement			
	LED-LA60 / E27 7W / 9W (x1)		LED-LA70 / E27 12W / 14W (x1)



MCU209NC2LED



SPECIFICATIONS

INPUT VOLTAGE	220V / 50Hz
LED LAMP POWER	9W / BULB
COLOR TEMPERATURE	2,700 = 3,000K (WARM WHITE) 5,500 = 6,500K (COOL WHITE)
RATED BEAM ANGLE	36°
BATTERY TYPE/SIZE	SEALED LEAD-ACID 12V2.9Ah
BATTERY CUT-OFF VOLTAGE	1.60-1.75V / CALL
CHARGING MODE	CONSTANT VOLTAGE&LIMIT CURRENT
CHARGING CURRENT	290mA
CHARGING TIME	10-15HRS.
BACKUP TIME	2 HRS.
HOUSING	STEEL SHEET, 1MM. THICK COATED WITH POWDER PAINT.
DIMENSION (LxHxW)	250 X 240 X 80 MM.
WEIGHT	4 KG.

INDICATORS

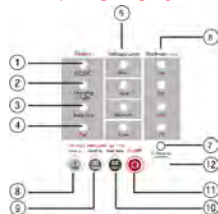

1. LED AC/DC : แสดงสถานะตัวเครื่องใช้พลังงานไฟฟ้าทางด้านไฟฟ้ากระแสสลับ AC220V
: LED จะสว่างค้าง , กรณีใช้พลังงานจากแบตเตอรี่ LED จะกระพริบ
2. LED CHARGING/FULLY : แสดงสถานะการประจุแบตเตอรี่ แบตเตอรี่เต็ม LED สว่างค้าง ,กำลังชาร์จ
: LED กระพริบ
3. LED AUTO TEST : แสดงสถานะการทดสอบตัวเครื่องแบบอัตโนมัติ LED สว่างค้างเมื่อทำงาน
4. LED FAIL : แสดงสถานะความผิดปกติของตัวเครื่อง เพื่อการตรวจสอบ
5. LED VOLTAGE LEVEL : แสดงระดับของแรงดันแบตเตอรี่
6. LED BACK-UP : แสดงช่วงระยะเวลาของการทดสอบแบบอัตโนมัติหรือการทดสอบการฟื้นฟู
: ฟังก์ชันตัวเครื่องและรีโมท
7. LED IR RECEIVER : แสดงสถานะตัวเครื่องได้รับคลื่นอินฟราเรดจากรีโมทภาคส่งโดย LED สว่าง
8. SWITCH NORMAL : สวิตช์ทดสอบการทำงานของตัวเครื่อง คายประจุแบตเตอรี่ 5 วินาที
9. SWITCH MONTHLY : สวิตช์ทดสอบการทำงานของตัวเครื่อง คายประจุแบตเตอรี่ 30 วินาที
10. SWITCH HALF YEAR : สวิตช์ทดสอบการทำงานของตัวเครื่อง คายประจุแบตเตอรี่ 60 วินาที
11. SWITCH ON/OFF : สวิตช์เปิด/ปิดหลอดไฟ หรือ ยกเลิกคำสั่งการทดสอบในฟังก์ชันต่างๆ
12. IR RECEIVER : ช่องรับสัญญาณคลื่นอินฟราเรด จากรีโมทภาคส่ง
13. SAFETY SWITCH : สวิตช์แมนูแวลเปิด/ปิด ระบบการทำงานของตัวเครื่องทั้งหมด

PRODUCT OVERVIEW

โคมไฟไฟแสงสว่างฉุกเฉิน รุ่น MCU209NC2LED ใช้หลอด LED ที่มีคุณภาพ และประสิทธิภาพของแสงสว่างมากกว่าหลอดฮาโลเจน ขนาด 50 วัตต์ หลอดมีอายุการใช้งานที่ยาวนานมากกว่า 50,000 ชั่วโมง อีกทั้งยังลดค่าใช้จ่ายของแบตเตอรี่ที่มีขนาดเล็กลงถึง 3 เท่า ตัวเครื่องสามารถให้แสงสว่างคงที่และยาวนานกว่า 2 ชั่วโมง

ควบคุมการทำงานโดย Microcontroller หน้าตัวเครื่องจะมีปุ่มสั่งงาน Function หลากหลาย อาทิเช่น ปุ่มทดสอบตัวเครื่อง ประจำ 1 เดือน และ 6 เดือน อีกทั้งสามารถใช้ Remote Infrared Control ควบคุมการกดปุ่มจากตัวเครื่องเพื่อเพิ่มความสะดวกในการใช้งาน

FEATURES

- ใช้หลอด LED กำลังสูง พิกัด 9 วัตต์ จำนวน 2 หัวโคม ในการให้แสงสว่าง
- มีอายุการใช้งานที่ยาวนานกว่า 50,000 ชั่วโมง
- ให้แสงสว่างมากกว่าหลอดฮาโลเจน ขนาด 50W x 2
- ให้แสงคงที่ยาวนานกว่า 2 ชั่วโมง
- สามารถทดสอบการทำงานได้ด้วยรีโมทคอนโทรล
- มีฟังก์ชันการทดสอบการทำงานอัตโนมัติ (AutoTest)
ประจำ 1 เดือน ทุกๆ วันที่ 1 เวลา 12.00-12.30น.
ประจำ 6 เดือน ทุกๆ วันที่ 15 เวลา 12.00-13.00น.
- ได้รับมาตรฐานอุตสาหกรรม มอก.1102-2538 ,มอก.1995-2551
- รับประกันแพคเกจจอร์ 5 ปี และแบตเตอรี่ 2 ปี

DIMENSION (MM)

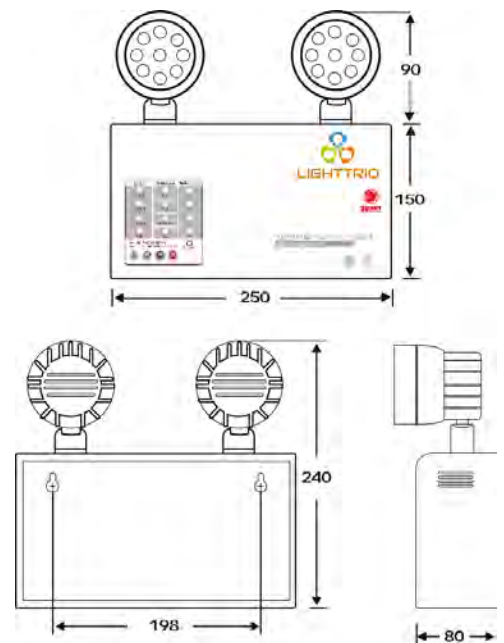

SN209NC2LED



SPECIFICATIONS

INPUT VOLTAGE	220V / 50Hz
LED LAMP POWER	9W / BULB
COLOR TEMPERATURE	5,500 = 6,500K
RATED BEAM ANGLE	36°
BATTERY TYPE/SIZE	SEALED LEAD-ACID 6V4.Ah
BATTERY CUT-OFF VOLTAGE	1.60-1.75V / CALL
CHARGING MODE	CONSTANT VOLTAGE&LIMIT CURRENT
CHARGING CURRENT	450mA
CHARGING TIME	10-15HRS.
BACKUP TIME	2 HRS.
HOUSING	STEEL SHEET, 1MM, THICK WITH POWDER PAINT.
DIMENSION (LxHxW)	250 X 240 X 80 MM.
WEIGHT	2.63 KG.

INDICATORS

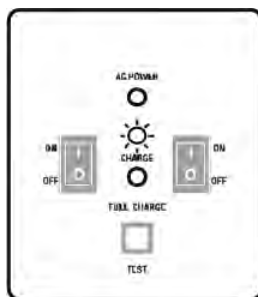

LED AC POWER	: หลอดไฟติดสว่างแสดงพลตัวเครื่องได้รับแรงดันไฟฟ้า 220Vac.
LED CHARGE	: หลอดไฟติดสว่างแสดงพลตัวเครื่องกำลังชาร์จแบตเตอรี่
LED FULL CHARGE	: หลอดไฟดับแสดงพลตัวเครื่องชาร์จแบตเตอรี่เต็ม
LED OVER CHARGE	: หลอดไฟติดสว่างแสดงพลความผิดปกติของตัวเครื่อง ในส่วน : ของวงจรชาร์จแบตเตอรี่
SWITCH TEST	: สวิตช์ทดสอบความล้มเหลวของไฟ AC220V.
SWITCH ON/OFF	: สวิตช์ เปิด/ปิด หลอดไฟฉุกเฉินแยกอิสระ: ซ้าย,ขวา

PRODUCT OVERVIEW

โคมไฟฟ้าแสงสว่างฉุกเฉิน รุ่น SN209NC2LED ใช้หลอดLED ที่มีคุณภาพ แสงสว่างสูงแต่ใช้พลังงานไฟฟ้ากำลังวัตต์ต่ำ สามารถช่วยประหยัดพลังงานไฟฟ้า การกระจายแสงของหลอดมีประสิทธิภาพ มากกว่าหลอดฮาโลเจน 5 เท่าและมีการใช้งานมีอายุการใช้งานได้ยาวนานมากกว่า 50,000 ชั่วโมง อีกทั้งยังช่วยค่าใช้จ่ายในการบำรุงรักษาของแบตเตอรี่ เนื่องจากขนาดของแบตเตอรี่นั้นลดลงอย่างมาก

โคมไฟฟ้าสว่างฉุกเฉิน SN209NC2LED ทำงานโดยอัตโนมัติ ทั้งในกรณีไฟดับของแสงไฟฟ้กลับสู่สภาวะปกติ มีระบบการประจุไฟฟ้าที่ช่วยยืดอายุการใช้งานของแบตเตอรี่ ตัวถังทำจากเหล็กพ่นสีและพ่นขึ้นรูป พ่นกันสนิม เคลือบด้วยสีพ่นและอบด้วยความร้อน

FEATURES

- ใช้หลอด LED กำลังสูง พิกัด 9 วัตต์ จำนวน 2 หัวโคม ในการให้แสงสว่าง
- มีอายุการใช้งานที่ยาวนานกว่า 50,000 ชั่วโมง
- ให้แสงคงที่ยาวนานกว่า 2 ชั่วโมง
- ประจุแบตเตอรี่แบบอัตโนมัติ โดยการควบคุมแรงดันและกระแสไฟฟ้า CONSTANT VOLTAGE&LIMIT CURRENT
- ได้รับมาตรฐานอุตสาหกรรม มอก.1102-2538 ,มอก.1995-2551
- รับประกันแพคเกจจอร์หลัก 5 ปี และแบตเตอรี่ 18 เดือน

DIMENSION (MM)

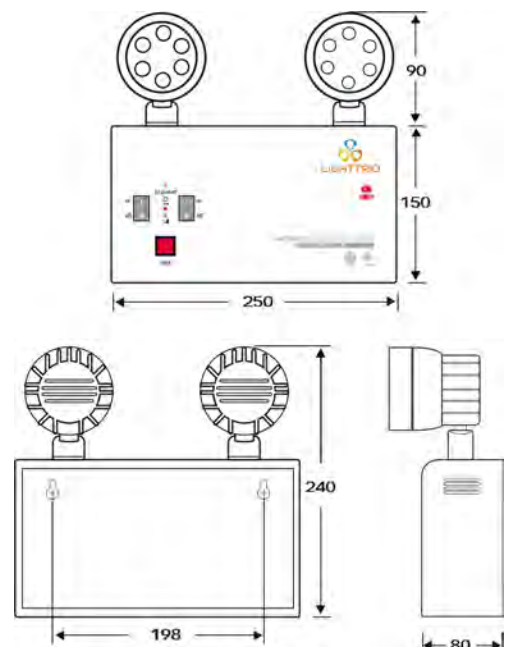

EXS1-10LED/S-RT (SINGLE-SIDE)



SPECIFICATIONS	
INPUT VOLTAGE	220V / 50Hz
INPUT CURRENT (MAX)	0.056A@220VAC
INPUT POWER (MAX)	11.20W
INPUT POWER (STANDBY)	7.04W
LED COLOR TEMPERATURE	6.500K
LAMP CURRENT (AC)	0.670A
LAMP CURRENT (BATTERY)	0.650A@1.2V/CELL
BATTERY	NiMH 1.800mAh(1.2Vx3)
CHARGE CURRENT (MAX)	0.180A
CHARGE TERMINATING VOLTAGE	1.4V/CELL
CHAGING TIME	12 HRS.
BATTERY LOW VOLTAGE CUT-OFF	1.0V/CELL
BACKUP TIME	2 HRS.
DIMENSION	400 x 200 x 60MM.
WEIGHT	1.6 KG.

PRODUCT OVERVIEW

ป้ายไฟทางออกฉุกเฉิน รุ่น EXS1-10LED/S ลักษณะการใช้งาน ทรงติดตั้งแบบ พับังและพาดาน หลอดไฟที่ใช้เป็นหลอด LED มีประสิทธิภาพสูงที่สุดชนิด HIGH QUALITY/HIGH LUMEN ซึ่งสามารถช่วยประหยัดพลังงานไฟฟ้าได้มากกว่า ระบบเดิมที่ใช้หลอดฟลูออโรสเซนต์ถึง 6 เท่า และมีอายุการใช้งานที่ยาวนานกว่าถึง 7 เท่า

ใช้แบตเตอรี่รุ่น NI- MH (NIKLE METAL HYDRIDE) ที่มีขนาดเล็ก และมีประสิทธิภาพการใช้งานที่ยาวนานกว่า แบตเตอรี่ SEALED LEAD ACIC แบตเตอรี่ 2-3 เท่า สามารถสำรองไฟได้นานถึง 2 ชั่วโมง

ใช้แผ่นอะคริลิกโปร่งใสที่มีคุณสมบัติพิเศษโดยทำให้ลำแสงของหลอดไฟกระจายทั่วทั้งแผ่นอย่างสม่ำเสมอและการกระจายแสงมีความคงทนและยาวนาน

ตัวกล่องทำจากเหล็กคุณภาพ เบ็นและพินขึ้นรูป เคลือบกันสนิม พ่นด้วยสีพ่นคุณภาพสูงและอบด้วยความร้อน

FEATURES

- ใช้หลอด LED กำลังสูง พิกัด 10 วัตต์ ในกรณีให้แสงสว่าง
- มีอายุการใช้งานที่ยาวนานกว่า 50,000 ชั่วโมง
- ให้แสงคงที่ยาวนานกว่า 2 ชั่วโมง
- ประจุแบตเตอรี่แบบอัตโนมัติ โดยการควบคุมแรงดันและกระแสไฟฟ้า CONSTANT VOLTAGE&LIMIT CURRENT
- รองรับมาตรฐานการทำงานได้ด้วยรีโมทคอนโทรล (ออฟชั่น)
- ได้รับมาตรฐานอุตสาหกรรม มอก.1102-2538 ,มอก.1995-2551
- รับประกันแพคเกจจอร์หลัก 5 ปี และแบตเตอรี่ 3 ปี

INSTALLATION

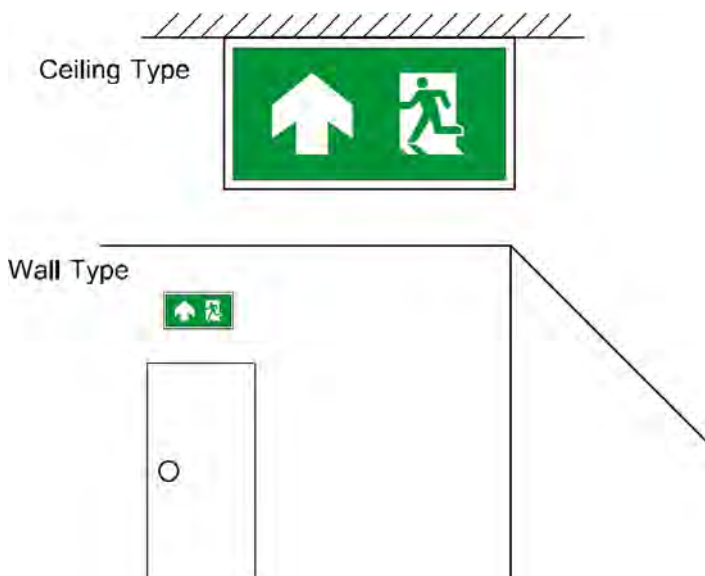

DIMENSION (MM)

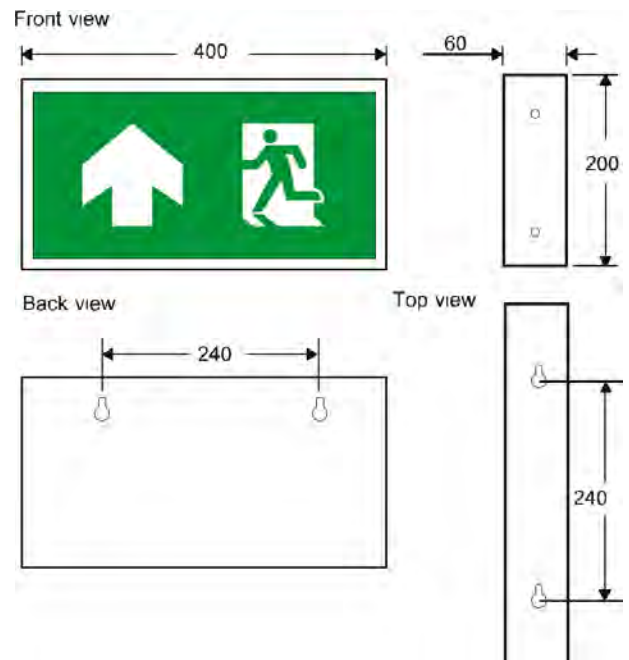

EXS1-10LED/D-RT (DOUBLE-SIDE)



SPECIFICATIONS	
INPUT VOLTAGE	220V / 50Hz
INPUT CURRENT (MAX)	0.056A@220VAC
INPUT POWER (MAX)	11.20W
INPUT POWER (STANDBY)	7.04W
LED COLOR TEMPERATURE	6.500K
LAMP CURRENT (AC)	0.670A
LAMP CURRENT (BATTERY)	0.650A@1.2V/CELL
BATTERY	NiMH 1.800mAh(1.2Vx3)
CHARGE CURRENT (MAX)	0.180A
CHARGE TERMINATING VOLTAGE	1.4V/CELL
CHAGING TIME	12 HRS.
BATTERY LOW VOLTAGE CUT-OFF	1.0V/CELL
BACKUP TIME	2 HRS.
DIMENSION	400 x 200 x 60MM.
WEIGHT	1.4 KG.

PRODUCT OVERVIEW

ป้ายไฟทางออกฉุกเฉิน รุ่น EXS1-10LED/D ลักษณะการใช้งาน การติดตั้งแบบ พับังและพดาน หลอดไฟที่ใช้เป็นหลอด LED มีประสิทธิภาพสูงที่สุษณิด HIGH QUALITY/HIGH LUMEN ซึ่งสามารถช่วยประหยัดพลังงานไฟฟ้าได้มากกว่า ระบบเดิมที่ใช้หลอดฟลูออโรสเซนต์ถึง 6 เท่า และมีอายุการใช้งานที่ยาวนานกว่าถึง 7 เท่า

ใช้แบตเตอรี่รุ่น NI- MH (NIKLE METAL HYDRIDE) ที่มีขนาดเล็ก และประสิทธิภาพการใช้งานที่ยาวนานกว่า แบตเตอรี่ SEALED LEAD ACIC แบตเตอรี่ 2-3 เท่า สามารถสำรองไฟได้นานถึง 2 ชั่วโมง

ใช้แผ่นอะคริลิกโปร่งใสที่มีคุณสมบัติพิเศษโดยทำให้ลำแสงของหลอดไฟกระจาย กว้างแ่งอย่างสม่ำเสมอและการกระจายแสงมีความคงทนและยาวนาน

ตัวกล่องทำจากเหล็กคุณภาพ นี้นและพับังรูป เคลือบกันสนิม พับังด้วยสีพับังคุณภาพสูงและอบด้วยความร้อน

FEATURES

- ใช้หลอด LED กำลังสูง พักัด 10 วัตต์ ในการให้แสงสว่าง
- มีอายุการใช้งานที่ยาวนานกว่า 50,000 ชั่วโมง
- ให้แสงคงที่ยาวนานกว่า 2 ชั่วโมง
- ประจุแบตเตอรี่แบบอัตโนมัติ โดยการควบคุมแรงดันและกระแสไฟฟ้า CONSTANT VOLTAGE&LIMIT CURRENT
- รองรับมาตรฐานการทำงานได้ด้วยรีโมทคอนโทรล (ออฟชั่น)
- ได้รับมาตรฐานอุตสาหกรรม มอก.1102-2538 ,มอก.1995-2551
- รับประกันแพงวงจรถหสี่ 5 ปี และแบตเตอรี่ 3 ปี

INSTALLATION

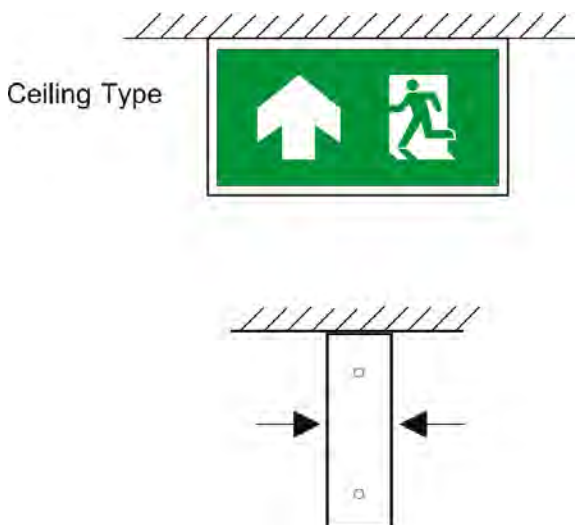

DIMENSION (MM)

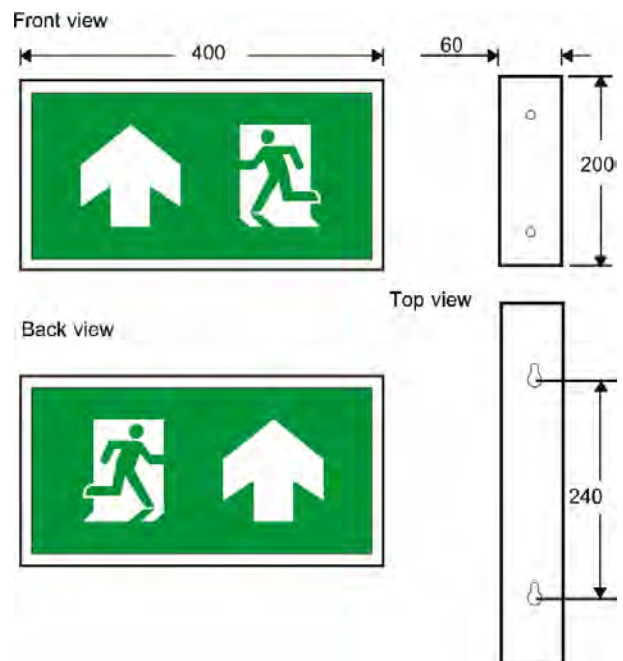

SLS1-10LED/S-RT (SINGLE-SIDE)



PRODUCT OVERVIEW

ป้ายไฟทางออกฉุกเฉิน รุ่น SLS1-10LED/D ลักษณะการใช้ติดตั้ง การติดตั้งแบบ พับังและพาดาน หลอดไฟที่ใช้เป็นหลอด LED มีประสิทธิภาพสูงที่สูรณิด HIGH QUALITY/HIGH LUMEN ซึ่งสามารถช่วยประหยัดพลังงานไฟฟ้าได้มากกว่า ระบบเดิมที่ใช้หลอดฟลูออโรสเซนต์ถึง 6 เท่า และมีอายุการใช้งานที่ยาวนานกว่าถึง 7 เท่า

ใช้แบตเตอรี่รุ่น NI-MH (NIKLE METAL HYDRIDE) ที่มีขนาดเล็ก แต่ประสิทธิภาพการใช้งานที่ยาวนานกว่า แบตเตอรี่ SEALED LEAD ACIC แบตเตอรี่ 2-3 เท่า สามารถสำรองไฟได้นานถึง 2 ชั่วโมง

ใช้แผ่นอะคริลิกโปร่งแสงชนิด ESD ที่มีคุณสมบัติพิเศษโดยทำให้ลำแสงของหลอดไฟกระจายทั่วทั้งแผ่นอย่างสม่ำเสมอและกระจายแสงมีความคงทนและยาวนาน ตัวกล่องทำจากเหล็กคุณภาพ เบ็นและพ่นชั้นรูป เคลือบกันสนิม พ่นด้วยสีพ่นคุณภาพสูงและอบด้วยความร้อน



SPECIFICATIONS

INPUT VOLTAGE	220V / 50Hz
INPUT CURRENT (MAX)	0.056A@220VAC
INPUT POWER (MAX)	11.20W
INPUT POWER (STANDBY)	7.04W
LED COLOR TEMPERATURE	6.500K
LAMP CURRENT (AC)	0.670A
LAMP CURRENT (BATTERY)	0.650A@1.2V/CELL
BATTERY	NiMH 1.800mAh(1.2Vx3)
CHARGE CURRENT (MAX)	0.180A
CHARGE TEMINATING VOLTAGE	1.4V/CELL
CHAGING TIME	12 HRS.
BATTERY LOW VOLTAGE CUT-OFF	1.0V/CELL
BACKUP TIME	2 HRS.
DIMENSION	430 x 220 x 100MM.
WEIGHT	1.78 KG.

FEATURES

- ใช้หลอด LED กำลังสูง พัด 10 วัตต์ ในกรณีให้แสงสว่าง
- มีอายุการใช้งานที่ยาวนานกว่า 50,000 ชั่วโมง
- ให้แสงคงที่ยาวนานกว่า 2 ชั่วโมง
- ประจุแบตเตอรี่แบบอัตโนมัติ โดยการควบคุมแรงดันและกระแสไฟฟ้า CONSTANT VOLTAGE&LIMIT CURRENT
- รองรับมาตรฐานการทำงานด้วยยริโชนคอลลีโรล (ออฟชั่น)
- ได้รับมาตรฐานอุตสาหกรรม มอก.1102-2538 ,มอก.1995-2551
- รับประกันแพงงจจรหลัก 5 ปี และแบตเตอรี่ 3 ปี

INSTALLATION

Ceiling Type



Wall Type



DIMENSION (MM)

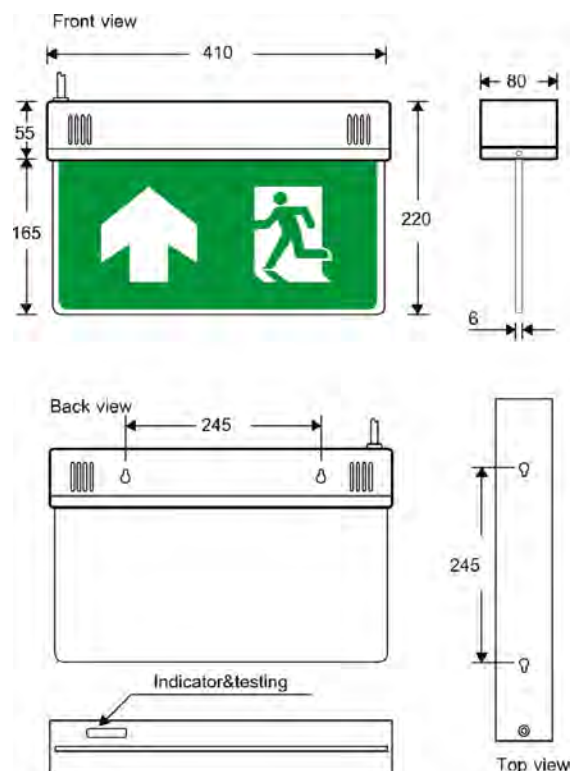

SLS1-10LED/D-RT (DOUBLE-SIDE)



SPECIFICATIONS	
INPUT VOLTAGE	220V / 50Hz
INPUT CURRENT (MAX)	0.056A@220VAC
INPUT POWER (MAX)	11.20W
INPUT POWER (STANDBY)	7.04W
LED COLOR TEMPERATURE	6.500K
LAMP CURRENT (AC)	0.670A
LAMP CURRENT (BATTERY)	0.650A@1.2V/CELL
BATTERY	NiMH 1.800mAh(1.2Vx3)
CHARGE CURRENT (MAX)	0.180A
CHARGE TEMINATING VOLTAGE	1.4V/CELL
CHAGING TIME	12 HRS.
BATTERY LOW VOLTAGE CUT-OFF	1.0V/CELL
BACKUP TIME	2 HRS.
DIMENSION	400 x 200 x 60MM.
WEIGHT	1.4 KG.

PRODUCT OVERVIEW

ป้ายไฟทางออกฉุกเฉิน รุ่น SLS1-10LED/S ลักษณะการใช้ได้ทั้ง การติดตั้งแบบ พับังและพาดาน หลอดไฟที่ใช้เป็นหลอด LED มีประสิทธิภาพสูงที่สูรณิด HIGH QUALITY/HIGH LUMEN ซึ่งสามารถช่วยประหยัดพลังงานไฟฟ้าได้มากกว่า ระบบเดิมที่ใช้หลอดฟลูออโรสเซนต์ถึง 6 เท่า และมีอายุการใช้งานที่ยาวนานกว่าถึง 7 เท่า

ใช้แบตเตอรี่รุ่น NI-MH (NIKLE METAL HYDRIDE) ที่มีขนาดเล็ก แต่ประสิทธิภาพการใช้งานที่ยาวนานกว่า แบตเตอรี่ SEALED LEAD ACIC แบตเตอรี่ 2-3 เท่า สามารถสำรองไฟได้นานถึง 2 ชั่วโมง

ใช้แผ่นอะคริลิกโปร่งแสงชนิด ESD ที่มีคุณสมบัติพิเศษโดยทำให้ลำแสงของหลอดไฟกระจายทั่วทั้งแผ่นอย่างสม่ำเสมอและการกระจายแสงมีความคงทนและยาวนาน

ตัวกล่องทำจากเหล็กคุณภาพ เบ็ญและพินขึ้นรูป เคลือบกันสนิม พ่นด้วยสีพ่นคุณภาพสูงและอบด้วยความร้อน

FEATURES

- หลอด LED กำลังสูง พิกัด 10 วัตต์ ในารให้แสงสว่าง
- มีอายุการใช้งานที่ยาวนานกว่า 50,000 ชั่วโมง
- ให้แสงคงที่ยาวนานกว่า 2 ชั่วโมง
- ประจุแบตเตอรี่แบบอัตโนมัติ โดยการควบคุมแรงดันและกระแสไฟฟ้า CONSTANT VOLTAGE&LIMIT CURRENT
- รองรับมาตรฐานการทำงานได้ด้วยรีโมทคอนโทรล (ออฟชั่น)
- ได้รับมาตรฐานอุตสาหกรรม มอก.1102-2538 ,มอก.1995-2551
- รับประกันแพคเกจจิ้ง 5 ปี และแบตเตอรี่ 3 ปี

INSTALLATION



Ceiling Recessed

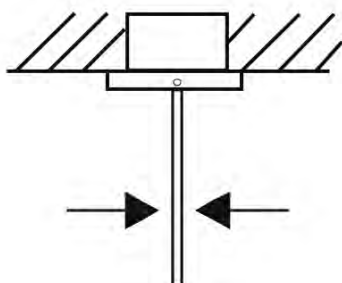

DIMENSION (MM)

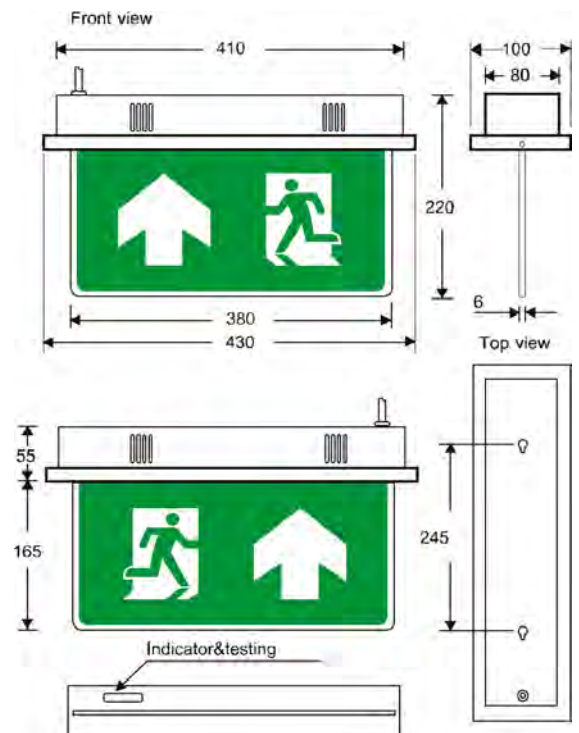

EMERGENCY STANDARD SYMBOL LIGHT



EF - 001



EF - 002



EF - 003



EF - 004



EF - 005



EF - 006



EF - 007



EF - 008



EF - 009



EF - 010



EF - 011



EF - 012



EF - 013



EF - 014



EF - 015



EF - 016



EF - 017



EF - 018



EF - 019



EF - 020



EF - 021



EF - 022



EF - 023



EF - 024



EF - 025



EF - 026



EF - 027



EF - 028



CW-P-101

HOUSING : STEEL
DIFFUSER : GLASS
G10Q/32W,E27X2 (GENIE 18W)
240.-



CW-P-207

HOUSING : STEEL
DIFFUSER : GLASS
G10Q/32W,E27X2 (GENIE 18W)
240.-



CW-P-099

HOUSING : STEEL
DIFFUSER : GLASS
G10Q/32W,E27X2 (GENIE 18W)
240.-



CW-P-023

HOUSING : STEEL
DIFFUSER : GLASS
G10Q/32W,E27X2 (GENIE 18W)
240.-



CW-P-088

HOUSING : STEEL
DIFFUSER : GLASS
G10Q/32W,E27X2 (GENIE 18W)
240.-



CW-P-036

HOUSING : STEEL
DIFFUSER : GLASS
G10Q/32W,E27X2 (GENIE 18W)
240.-



CW-P-032

HOUSING : STEEL
DIFFUSER : GLASS
G10Q/32W,E27X2 (GENIE 18W)
240.-



CW-P-048

HOUSING : STEEL
DIFFUSER : GLASS
G10Q/32W,E27X2 (GENIE 18W)
240.-



CW-P-201

HOUSING : STEEL
DIFFUSER : GLASS
G10Q/32W,E27X2 (GENIE 18W)
240.-

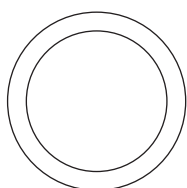

Ø 41 cm



10 cm



G10Q/32W



E27



CLG-5001/(22,32,40)

/22 E27 (GENIE 18) 360.-
 /32 G10Q/32W ,2XE27 (GENIE 18W) 400.-
 /40 G10Q/40W ,3XE27 (GENIE 18W) 880.-

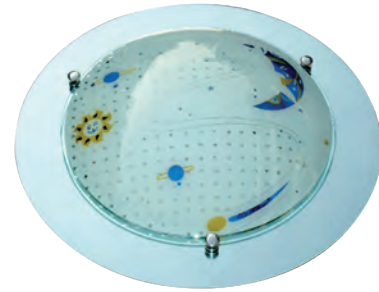

CLG-5002/(22,32,40)

/22 E27 (GENIE 18) 360.-
 /32 G10Q/32W ,2XE27 (GENIE 18W) 400.-
 /40 G10Q/40W ,3XE27 (GENIE 18W) 880.-



CLG-5003/(22,32,40)

/22 E27 (GENIE 18) 360.-
 /32 G10Q/32W ,2XE27 (GENIE 18W) 400.-
 /40 G10Q/40W ,3XE27 (GENIE 18W) 880.-



CLG-5004/(22,32,40)

/22 E27 (GENIE 18) 360.-
 /32 G10Q/32W ,2XE27 (GENIE 18W) 400.-
 /40 G10Q/40W ,3XE27 (GENIE 18W) 880.-



CLG-5005/(22,32,40)

/22 E27 (GENIE 18) 360.-
 /32 G10Q/32W ,2XE27 (GENIE 18W) 400.-
 /40 G10Q/40W ,3XE27 (GENIE 18W) 880.-



CLG-5006/(22,32,40)

/22 E27 (GENIE 18) 360.-
 /32 G10Q/32W ,2XE27 (GENIE 18W) 400.-
 /40 G10Q/40W ,3XE27 (GENIE 18W) 880.-



/22 Ø 30 cm
 /32 Ø 40 cm
 /40 Ø 65 cm



ใช้ร่วมกับอุปกรณ์ สำหรับ 32 วัตต์หรือเปลี่ยนขั้ว E27 สำหรับใส่หลอดประหยัดไฟได้

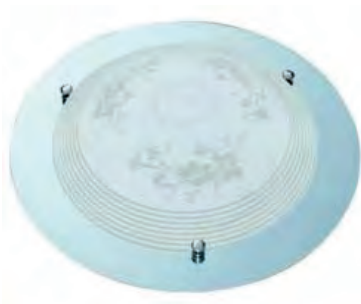

CLG-5027/32

/32 G10/32W 400.-
2XE27 (GENIE 18W)



CLG-5060/32

/32 G10/32W 400.-
2XE27 (GENIE 18W)



CLG-5099/32

/32 G10/32W 400.-
2XE27 (GENIE 18W)



CGO-5011/(S,L)

S 1XE27 (GENIE 18W) 380.-
L 2XE27 (GENIE 18W) ,G10Q/32W 480.-
HOUSING : GLASS COVER ,STEEL PLATE



CGO-5012/(S,L)

S 1XE27 (GENIE 18W) 380.-
L 2XE27 (GENIE 18W) ,G10Q/32W 480.-
HOUSING : GLASS COVER ,STEEL PLATE



CGO-5013/(S,L)

S 1XE27 (GENIE 18W) 380.-
L 2XE27 (GENIE 18W) ,G10Q/32W 480.-
HOUSING : GLASS COVER ,STEEL PLATE

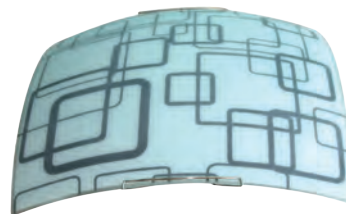

CG4-5013/(S,L)

S 1XE27 (GENIE 18W) 420.-
L 2XE27 (GENIE 18W) ,G10Q/32W 520.-
HOUSING : GLASS COVER ,STEEL PLATE

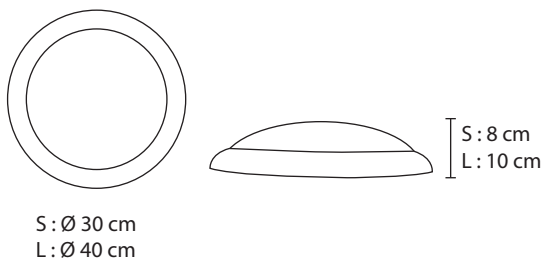

ใช้ร่วมกับอุปกรณ์ สำหรับ 32 วัตต์หรือเปลี่ยนขั้ว E27 สำหรับใส่หลอดประหยัดไฟได้



C-802
HOUSING : GLASS/STEEL
E27X2 (GENIE 14W)
Ø 29.5CM X H9CM 600.-



C-803
HOUSING : GLASS/STEEL
E27X2 (GENIE 14W)
Ø 32CM X H11.5CM 600.-



C-2004
HOUSING : GLASS/STEEL
E27X2 (GENIE 14W)
Ø 29CM X H7.5CM 600.-



C-106
HOUSING : GLASS/STEEL
E27X1 (GENIE 11W)
Ø 25CM X H10CM 320.-



C-107
HOUSING : GLASS/STEEL
E27X1 (GENIE 11W)
Ø 20CM X H10.5CM 240.-



C-1001
HOUSING : GLASS/STEEL
E27X2 (GENIE 14W)
Ø 24CM X H6CM 400.-



C-2007B/11
HOUSING : GLASS/STEEL
E27X2 (GENIE 11W)
Ø 28CM X H12CM 650.-

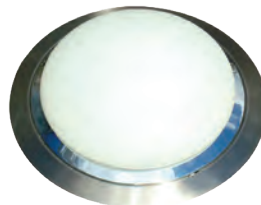

C-2007B/13
HOUSING : GLASS/STEEL
E27X2 (GENIE 14W)
Ø 34CM X H12CM 850.-



C-8117 (S,L)
HOUSING : GLASS/STEEL
E27X2 (GENIE 11W)
S : Ø 20CM X H10.5CM 300.-
L : Ø 25CM X H10.5CM 400.-

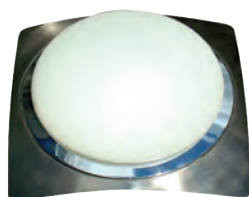

C-2007A/11
HOUSING : GLASS/STEEL
E27X2 (GENIE 11W)
Ø 28CM X H12CM 700.-

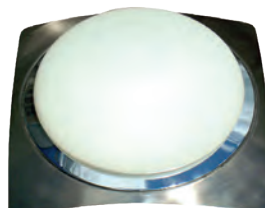

C-2007A/13
HOUSING : GLASS/STEEL
E27X2 (GENIE 14W)
Ø 34CM X H12CM 900.-





CW-701

HOUSING : GLASS/STEEL
G10Q/32W
E27X2 (GENIE 18W)
Ø 43CM X H10CM

330.-



CW-101

HOUSING : GLASS/STEEL
G10Q/32W
E27X2 (GENIE 18W)
Ø 43CM X H10CM

280.-



CW-101/12

HOUSING : GLASS/STEEL
E27X1 (GENIE 18W)
Ø 35CM X H10CM

260.-



C-S811

HOUSING : GLASS/STEEL
G10Q/32W
E27X2 (GENIE 18W)
Ø 43CM X H10CM

600.-



CW-104

HOUSING : GLASS/STEEL
G10Q/32W
E27X2 (GENIE 18W)
Ø 43CM X H10CM

280.-



CW-104/12

HOUSING : GLASS/STEEL
E27X1 (GENIE 18W)
Ø 35CM X H10CM

260.-



C-008

HOUSING : GLASS/STEEL
E27X1 (GENIE 11W)
Ø 21CM X H10CM

150.-



C-010

HOUSING : GLASS/STEEL
E27X1 (GENIE 14W)
Ø 25CM X H10CM

180.-



ใช้ร่วมกับอุปกรณ์ สำหรับ 32 วัตต์หรือเปลี่ยนขั้ว E27 สำหรับใส่หลอดประหยัดไฟได้



C-F01

HOUSING : ACRYLIC COVER, STEEL PLATE
G10Q/32W ,E27X2 (GENIE 18W)

1,400.-

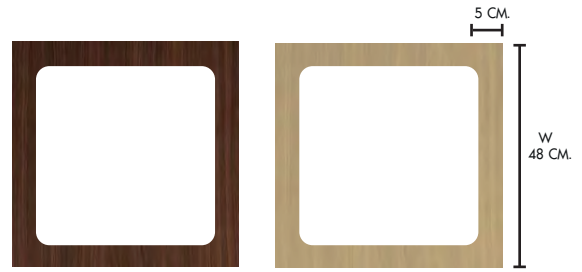

ขอบไม้จริงลาย 2 ด้าน สลับได้ เพื่อให้เข้ากับบรรยากาศ



ใช้ร่วมกับอุปกรณ์ สำหรับ 32 วัตต์ หรือ เปลี่ยนหัว E27 สำหรับใส่หลอดประหยัดไฟได้



C-MA-01

HOUSING : STEEL
DIFFUSER : ACRYLIC
E27X1 (GENIE 18W)
Ø 25CM X H5.5CM

360.-



CLG-4001/32

HOUSING : STEEL
DIFFUSER : GLASS
G10Q/32W ,E27X2 (GENIE 18W)
Ø 43CM X H13CM

480.-



CLG-4099/32

HOUSING : STEEL
DIFFUSER : GLASS
G10Q/32W ,E27X2 (GENIE 18W)
Ø 43CM X H13CM

480.-

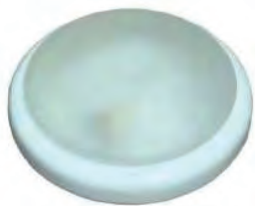

C-108/WH

HOUSING : GLASS/STEEL
E27X1 (GENIE 14W)
Ø 28CM X H12CM

360.-



C-108/GL

(GOLD)

400.-

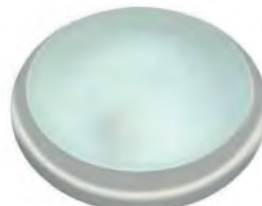

C-108/SL

(SILVER)

400.-



C-108/BK

(BLACK)

400.-



C-P01RC-A01320/2E27
 HOUSING : GLASS/PLASTIC
 E27X2
 Ø 32CM X H12.5CM 550.-



Ø32 CM

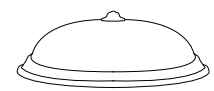
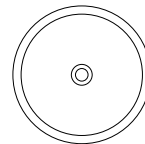

12.5 CM



C-P01RC-A01400/3E27
 HOUSING : GLASS/PLASTIC
 E27X3
 Ø 40CM X H12CM 660.-



Ø40 CM

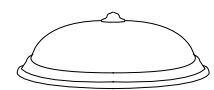
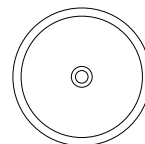

12 CM



สนใจสั่งซื้อสินค้าของเราได้ที่ LAZADA

1. เข้าผ่าน MOBILE APPLICATION
หรือ บนเว็บไซต์ WWW.LAZADA.COM



2. พิมพ์คำว่า "LIGHTTRIO" ลงไปที่ช่องค้นหา



3. ทานก็จะเจอสินค้าของเรา
แบรนด์ LIGHTTRIO ที่น่าสนใจ

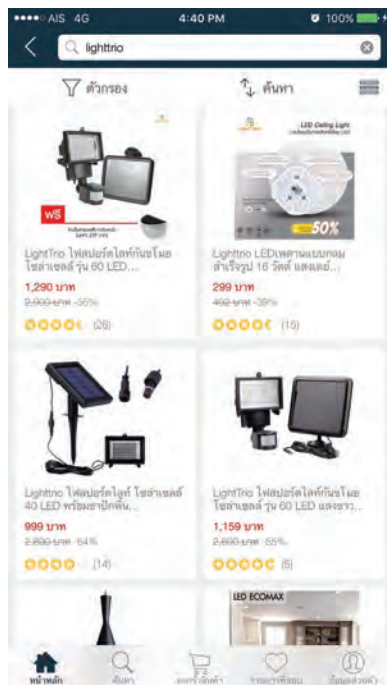

หรือ สแกน QR CODE
เข้าสู่หน้าสินค้าของเราได้ทันที







WEBSITE



FACEBOOK



ID LINE :
@LIGHTTRIO

[HTTP://LIGHTTRIO.COM/](http://LIGHTTRIO.COM/)
[HTTPS://WWW.FACEBOOK.COM/LIGHTTRIOLED](https://www.facebook.com/LIGHTTRIOLED)